

How Gauss Determined The Orbit of Ceres

by Jonathan Tennenbaum
and Bruce Director

PREFACE

The following presentation of Carl Gauss's determination of the orbit of the asteroid Ceres, was commissioned by Lyndon H. LaRouche, Jr., in October 1997, as part of an ongoing series of Pedagogical Exercises highlighting the role of metaphor and paradox in creative reason, through study of the great discoveries of science. Intended for individual and classroom study, the weekly installments—now “chapters”—were later serialized in The New Federalist newspaper. They are collected here, in their entirety, for the first time, incorporating additions and revisions to both text and diagrams.

Through the course of their presentation, it became necessary for the authors to review many crucial questions in the history of mathematics, physics, and astronomy. All of these issues were subsumed in the primary objective, the discovery of the orbit of Ceres. And, because they were written to challenge a lay audience to master unfamiliar and conceptually dense material at the level of axiomatic assumptions, the installments were often purposefully provocative, proceeding by way of contradictions and paradoxes.

Nonetheless, the pace of the argument moves slowly, building its case by constant ref-

erence to what has gone before. It is, therefore, a mountaintop you need not fear to climb!

We begin, by way of a preface, with the following excerpted comments by Lyndon H. LaRouche, Jr. The authors return to them in the concluding stretto. —KK

* * *

From Euclid through Legendre, geometry depended upon axiomatic assumptions accepted as if they were self-evident. On more careful inspection, it should be evident, that these

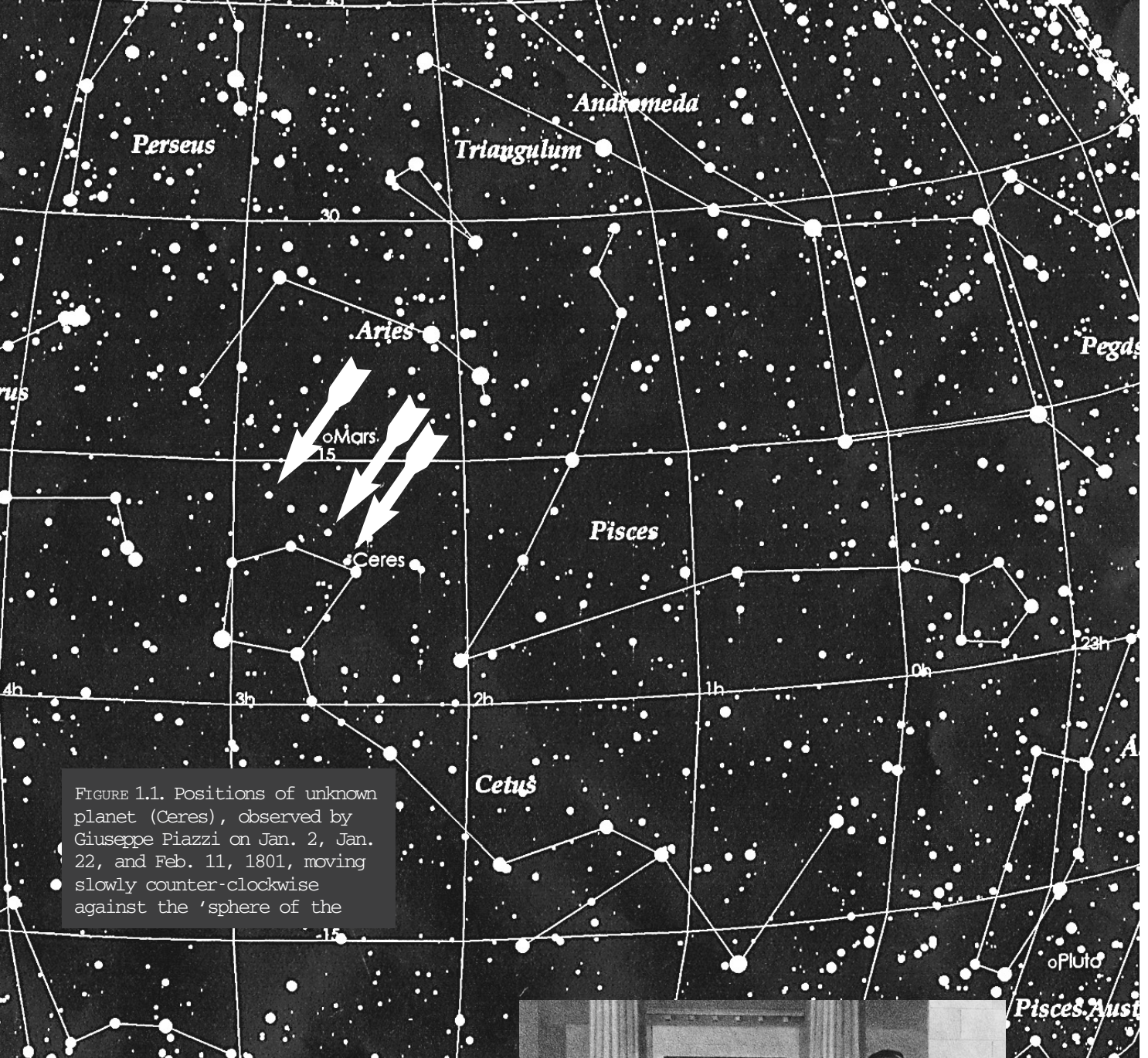
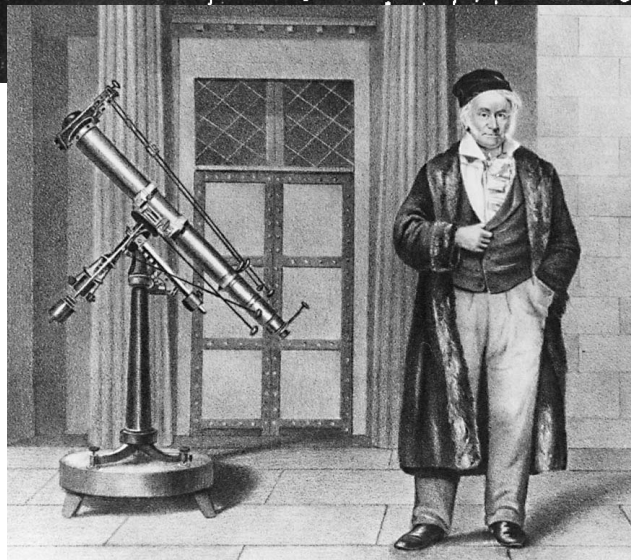

FIGURE 1.1. Positions of unknown planet (Ceres), observed by Giuseppe Piazzi on Jan. 2, Jan. 22, and Feb. 11, 1801, moving slowly counter-clockwise against the 'sphere of the

assumptions are not necessarily true. Furthermore, the interrelationship among those axiomatic assumptions, is left entirely in obscurity. Most conspicuous, even today, generally accepted classroom mathematics relies upon the absurd doctrine, that extension in space and time proceeds in perfect continuity, with no possibility of interruption, even in the extremely small. Indeed, every effort to prove that assumption, such as the notorious tautological hoax concocted by the celebrated Leonhard Euler,



Carl F. Gauss

was premised upon a geometry which preassumed perfect continuity, axiomatically. Similarly, the assumption that extension in space and time must be unbounded, was shown to have been arbitrary, and, in fact, false.

Bernhard Riemann's argument, repeated in the concluding sentence of his dissertation "On the Hypotheses Which Underlie Geometry," is, that, to arrive at a suitable design of geometry for physics, we must depart the realm of mathematics, for the realm of experimental physics. This is the key to solving the crucial problems of representation of both living processes, and all processes which, like physical economy and Classical musical composition, are defined by the higher processes of the individual human cognitive processes. Moreover, since living processes, and cognitive processes, are efficient modes of existence within the universe as a whole, there could be no universal physics whose fundamental laws were not coherent with that anti-entropic principle central to human cognition. . . .

By definition, any experimentally validated principle of (for example) physics, can be regarded as a dimension of an "*n*-dimensional" physical-space-time geometry. This is necessary, since the principle was validated by measurement; that is to say, it was validated by measurement of *extension*. This includes experimentally grounded, axiomatic assumptions respecting space and time. The question posed, is: How do these "*n*" dimensions interrelate, to yield an effect which is characteristic of that physical space-time? It was Riemann's genius, to recognize in the experimental applications which Carl Gauss had made in applying his approach to bi-quadratic residues, to crucial measurements in astrophysics, geodesy, and geomagnetism, the key to crucial implications of the approach to a general theory of curved surfaces rooted in the generalization from such measurements. . . .

What Art Must Learn from Euclid

The crucial distinction between that science and art which was developed by Classical Greece, as distinct from the work of the Greeks' Egyptian, anti-Mesopotamia, anti-Canaanite sponsors, is expressed most clearly by Plato's notion of *ideas*. The possibility of modern science depends upon, the relatively perfected form of that Classical Greek notion of *ideas*, as that notion is defined by Plato. This is exemplified by Plato's Socratic method of hypothesis, upon which the possibility of Europe's development depended absolutely. What is passed down to modern times as Euclid's geometry, embodies a crucial kind of demonstration of that principle; Riemann's accomplishment was, thus, to have corrected the errors of Euclid, by the same Socratic method employed to produce a geometry which had been, up to Riemann's time, one of the great works of antiquity. This

has crucial importance for rendering transparent the underlying principle of motivic thorough-composition in Classical polyphony. . . .

The set of definitions, axioms, and postulates deduced from implicitly underlying assumptions about space, is exemplary of the most elementary of the literate uses of the term *hypothesis*. Specifically, this is a *deductive* hypothesis, as distinguished from higher forms, including *non-linear* hypotheses. Once the hypothesis underlying a known set of propositions is established, we may anticipate a larger number of propositions than those originally considered, which might also be consistent with that deductive hypothesis. The implicitly open-ended collection of theorems which might satisfy that latter requirement, may be named a *theorem-lattice*

The commonly underlying principle of organization internal to each such type of deductive lattice, is *extension*, as that principle is integral to the notion of measurement. This notion of extension, is the notion of a type of extension characteristic of the domain of the relevant choice of theorem-lattice. All scientific knowledge is premised upon matters pertaining to a generalized notion of extension. Hence, all rational thought, is intrinsically geometrical in character.

In first approximation, all deductively consistent systems may be described in terms of theorem-lattices. However, as crucial features of Riemann's discovery illustrate most clearly, the essence of human knowledge is *change*, change of hypothesis, this in the sense in which the problem of ontological paradox is featured in Plato's *Parmenides*. In short, the characteristic of human knowledge, and existence, is not expressible in the mode of deductive mathematics, but, rather, must be expressed as *change*, from one hypothesis, to another. The standard for change, is to proceed from a relatively inferior, to superior hypothesis. The action of scientific-revolutionary change, from a relatively inferior, to relatively superior hypothesis, is the characteristic of human progress, human knowledge, and of the lawful composition of that universe, whose mastery mankind expresses through increases in potential relative population-density of our species.

The process of revolutionary change occurs only through the medium of metaphor, as the relevant principle of contradiction has been stated, above. Just as Euclid was necessary, that the work of descriptive geometry by Gaspard Monge *et al.*, the work of Gauss, and so forth, might make Riemann's overturning Euclid feasible, so all human progress, all human knowledge is premised upon that form of revolutionary change which appears as the *agapic* quality of solution to an ontological paradox.

—Lyndon H. LaRouche, Jr.,
adapted from "Behind the Notes"
Fidelio, Summer 1997 (Vol. VI, No. 2)

Introduction

January 1, 1801, the first day of a new century. In the early morning hours of that day, Giuseppe Piazzi, peering through his telescope in Palermo, discovered an object which appeared as a small dot of light in the dark night sky. (Figure 1.1) He noted its position with respect to the other stars in the sky. On a subsequent night, he saw the same small dot of light, but this time it was in a slightly different position against the familiar background of the stars.

He had not seen this object before, nor were there any recorded observations of it. Over the next several days, Piazzi watched this new object, carefully noting its change in position from night to night. Using the method employed by astronomers since ancient times, he recorded its position as the intersection of two circles on an imaginary sphere, with himself at the center. (Figure 1.2a) (Astronomers call this the “celestial sphere”; the circles are similar to lines of longitude and latitude on Earth.) One set of circles was thought of as running perpendicular to the celestial equator, ascending overhead from the observer’s horizon, and then descending. The other set of circles runs parallel to the celestial equator.

To specify any one of these circles, we require an angu-

lar measurement: the position of a longitudinal circle is specified by the angle (arc) known as the “right ascension,” and that of a circle parallel to the celestial equator, by the “declination.”* (Figure 1.2b). Hence, two angles suffice to specify the position of any point on the celestial sphere. This, indeed, is how Piazzi communicated his observations to others.

Piazzi was able to record the changing positions of the new object in a total of 19 observations made over the following 42 days. Finally, on February 12, the object disappeared in the glare of the sun, and could no longer be observed. During the whole period, the object’s total motion made an arc of only 9° on the celestial sphere.

What had Piazzi discovered? Was it a planet, a star, a comet, or something else which didn’t have a name? (At first, Piazzi thought he had discovered a small comet with no tail. Later, he and others speculated it was a planet between Mars and Jupiter.) And now that it had disappeared, what was its trajectory? When and where could it

* Figure 1.1 shows the celestial sphere as seen by an observer, with a grid for measuring right ascension and declination shown mapped against it.

FIGURE 1.2 *The celestial sphere. (a) Since ancient times, astronomers have recorded their observations of heavenly bodies as points on the inside of an imaginary sphere called the celestial sphere, or “sphere of the fixed stars,” with the Earth at its center. Arcs of right ascension and parallels of declination are shown. (b) Locating the position of an object on the celestial sphere by measuring right ascension and declination.*

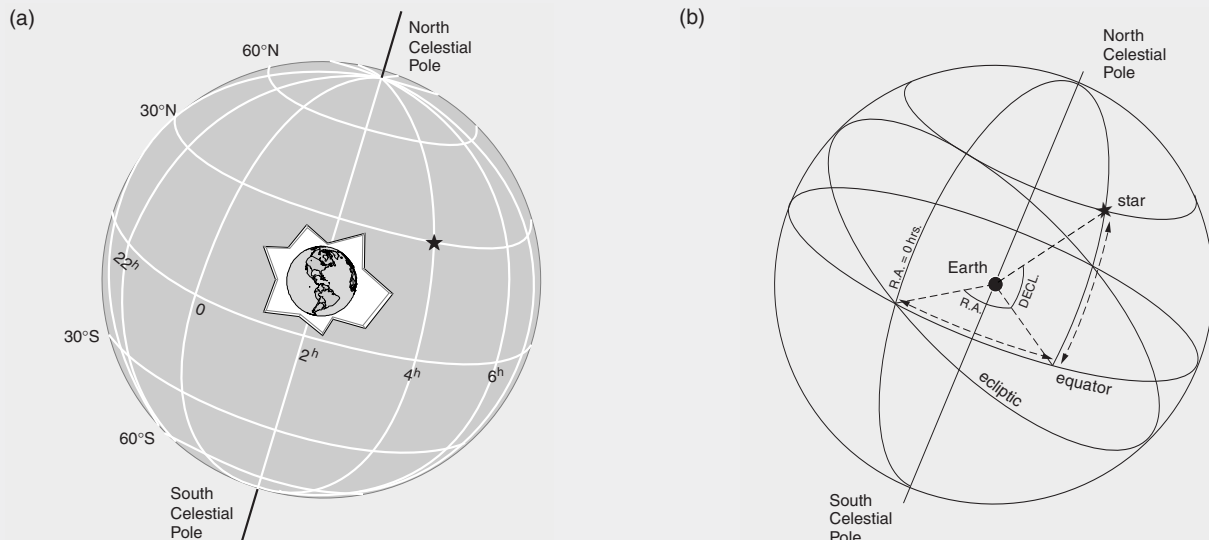
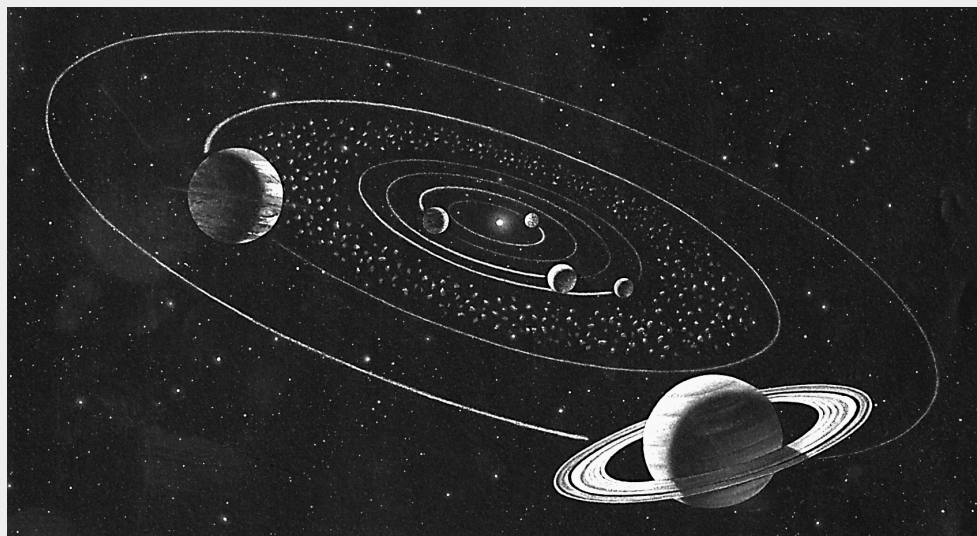

FIGURE 1.3. *Artist's rendering of a "God's eye view" of the first six planets of the solar system. (Note that the correct planetary sizes, and relative distances from the sun of "outer planets" Jupiter and Saturn, are not preserved.)*



be seen again? If it were orbiting the sun, how could its trajectory be determined from these few observations made from the Earth, which itself was moving around the sun?

Had Piazzi observed the object while it was approaching the sun, or was it moving away from the sun? Was it moving away from the Earth or towards it, when these observations were made? Since all the observations appeared only as changes in position against the background of the stars (celestial sphere), what motion did these changes in position reflect? What would these changes in position be, if Piazzi had observed them from the sun? Or, a point outside the solar system itself: a "God's eye view"? (Figure 1.3)

It was six months before Piazzi's observations were published in the leading German-language journal of astronomy, von Zach's *Monthly Correspondence for the Promotion of Knowledge of the Earth and the Heavens*, but news of his discovery had already spread to the leading astronomers of Europe, who searched the sky in vain for the object. Unless an accurate determination of the object's trajectory were made, rediscovery would be unpredictable.

There was no direct precedent to draw upon, to solve this puzzle. The only previous experience that anyone had had in determining the trajectory of a new object in the sky, was the 1781 discovery of the planet Uranus by William Herschel. In that case, astronomers were able to observe the position of Uranus over a considerable time, recording the changes in the position of the planet with respect to the Earth.

With these observations, the mathematicians simply asked, "On what curve is this planet traveling, such that it would produce these particular observations?" If one curve didn't produce the desired mathematical result, another was tried.

As Carl F. Gauss described it in the Preface to his 1809 book, *Theory of the Motion of the Heavenly Bodies Moving about the Sun in Conic Sections*,

As soon as it was ascertained that the motion of the new planet, discovered in 1781, could not be reconciled with the parabolic hypothesis, astronomers undertook to adapt a circular orbit to it, which is a matter of simple and very easy calculation. By a happy accident, the orbit of this planet had but a small eccentricity, in consequence of which, the elements resulting from the circular hypothesis sufficed, at least for an approximation, on which the determination of the elliptic elements could be based.

There was a concurrence of several other very favorable circumstances. For, the slow motion of the planet, and the very small inclination of the orbit to the plane of the ecliptic, not only rendered the calculations much more simple, and allowed the use of special methods not suited to other cases; but they removed the apprehension, lest the planet, lost in the rays of the sun, should subsequently elude the search of observers (an apprehension which some astronomers might have felt, especially if its light had been less brilliant); so that the more accurate determination of the orbit might be safely deferred, until a selection could be made from observations more frequent and more remote, such seemed best fitted for the end in view.

Linearization in the Small

The false belief that we need a large number of observations, filling out as large an arc as possible, in order to determine the orbit of a heavenly body, is a typical product of the Aristotelean assumptions brought into science by the British-Venetian school of mathematics—the school typified by Paolo Sarpi, Isaac Newton, and Leonhard Euler. Sarpi *et al.* insisted that, if we examine small-

FIGURE 1.4. Nicolaus of Cusa demonstrated, that no matter how many times its sides are multiplied, the polygon can never attain equality with the circle. The polygon and circle are fundamentally different species of figures.

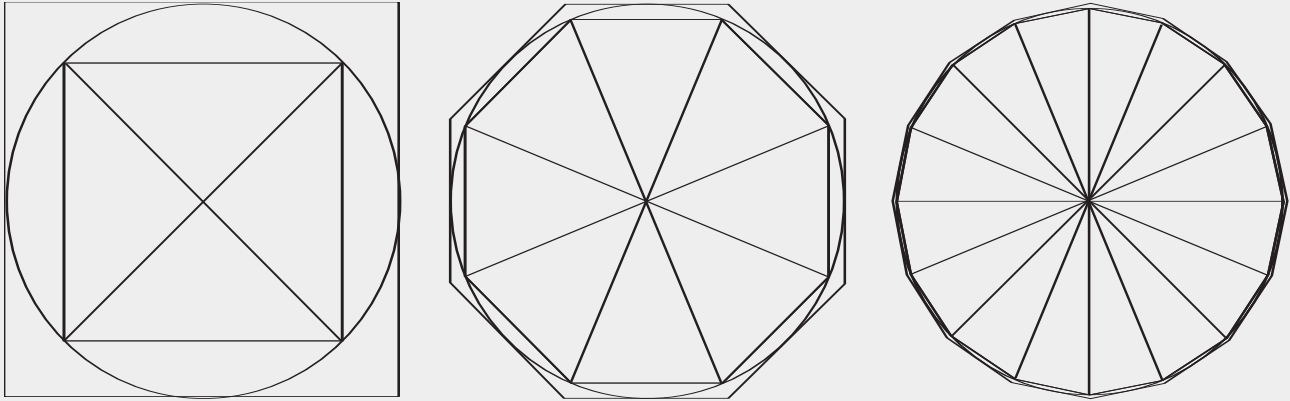

er and smaller portions of any curve in nature, we shall find that those portions look and behave more and more like straight line segments—to the point that, for sufficiently small intervals, the difference becomes practically insignificant and can be ignored. This idea came to be known as “linearization in the small.”

In the mid-Fifteenth century, Nicolaus of Cusa had already demonstrated conclusively that linearization in the small had no place in mathematics—if that mathematics were to reflect truth. Cusa demonstrated that the circle represents a *fundamentally different species of curve* from a straight line, and that this *species difference* does not disappear, or even decrease, when we examine very small portions of the circle. (Figure 1.4) With respect to their increasing number of vertices, the polygons inscribed in and circumscribing the circle become more and more *unlike* it.

Extending Cusa’s discovery to astronomy, Johannes Kepler discovered that the solar system was ordered according to certain harmonic principles. Each small part of the solar system, such as a small interval of a planetary orbit, reflected that same harmonic principle completely. Kepler’s call for the invention of a mathematical concept to measure this self-similarity, provoked G.W. Leibniz to develop the infinitesimal calculus. The entirety of the work of Sarpi, Newton, and Euler, was nothing but a fraud, perpetrated by the Venetian-British oligarchy against the work of Cusa, Kepler, and Leibniz.

Applying the false mathematics of Sarpi *et al.* to astronomy, would mean that the physical Universe became increasingly linear in the small, and that, therefore, the smaller the arc spanned by the given series of observations, the less those observations tell us about the shape of the orbit as a whole. This delusion can be main-

tained, in this case, only if the problem of determining the orbit of an unknown planet is treated as a purely mathematical one.

For example, think of three dots on a plane. (Figure 1.5) On how many different curves could these dots lie? Now add more dots. The more dots, covering a greater part of the curve, the more precise determination of the curve. A small change of the position of the dots, can

FIGURE 1.5. (a) Here are just a few of the curves that can be drawn through the same three points. (b) With more observation points, we may find that the curve is not as anticipated.

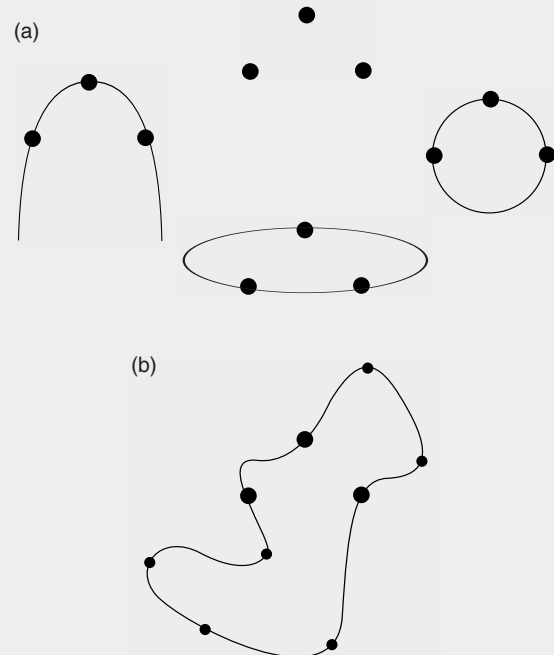

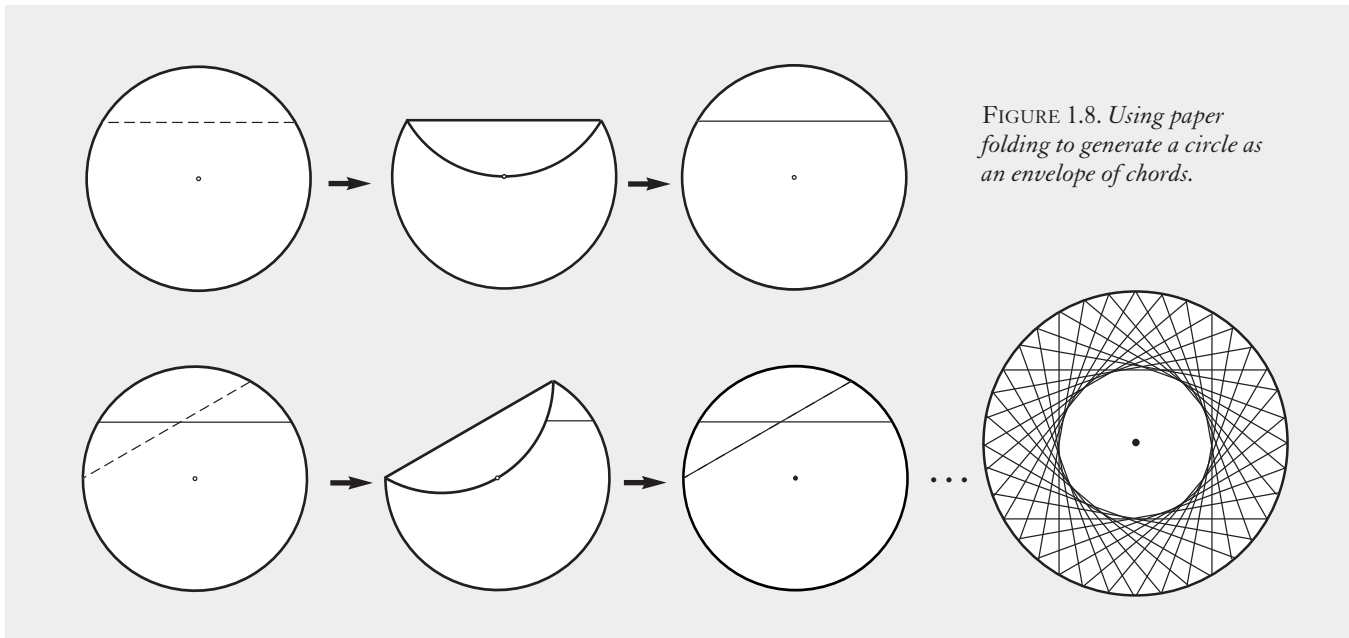

FIGURE 1.8. Using paper folding to generate a circle as an envelope of chords.

ed itself to mathematicians by its difficulty and elegance, even if its great utility in practice were not apparent.” Because others assumed this problem was unsolvable, and were deluded by the accidental success of the wrong method, they refused to believe that circumstances would arise necessitating its solution. Gauss, on the other hand, considered the solution, before the necessity presented itself, knowing, based on his study of Kepler and Leibniz, that such a necessity would certainly arise.

Introducing the Conic Sections

Before embarking on our journey to re-discover the method by which Gauss determined the orbit of Ceres, we suggest the reader investigate for himself certain simple characteristics of curves that are relevant to the following chapters. As we shall show later, Kepler discovered that

the planets known to him moved around the sun in orbits in the shape of ellipses. By Gauss’s time, objects such as comets had been observed to move in orbits whose shape was that of other, related curves. All these related curves can be generated by slicing a cone at different angles, and are therefore called “conic sections.” (Figure 1.6)

The conic sections can be constructed in a variety of different ways. (SEE Figure 1.7, as well as the Appendix, “The Harmonic Relationships in an Ellipse”) The reader can get a preliminary sense of some of the geometrical properties of the conic sections, by carrying out the following construction.

Take a piece of waxed paper and draw a circle on it. (Figure 1.8) Then put a dot at the center of the circle. Now fold the circumference onto the point at the center and make a crease. Unfold the paper and make a new fold, bringing another point on the circumference to the point

FIGURE 1.9. Conic sections generated as envelopes of straight lines, using the “waxed paper folding” method. (a) Ellipse. (b) Hyperbola. (c) Parabola.

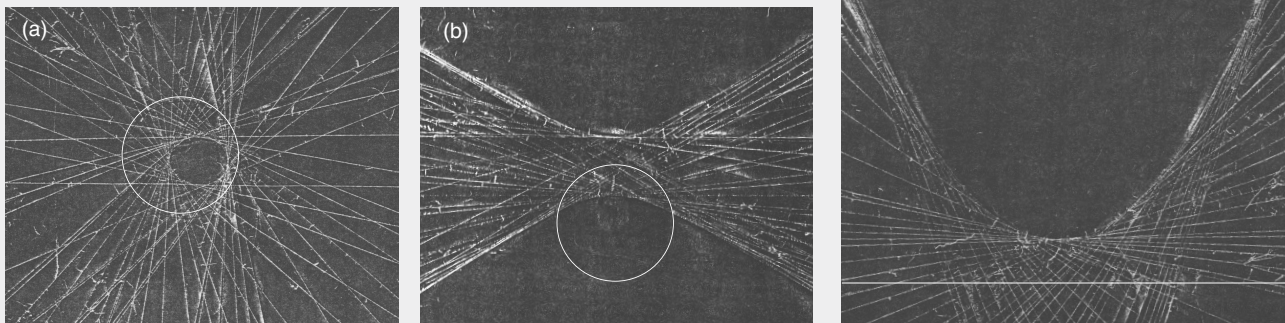
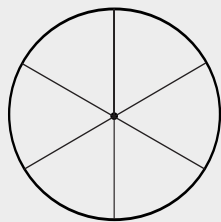
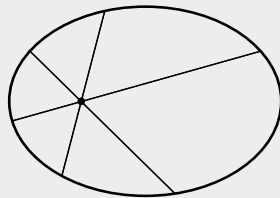

FIGURE 1.10. *The length of a line drawn from the focus to the curve changes as it moves around the curve, except in the case of the circle. In the case of a planetary orbit, that length is the distance from the sun to the planet. Note that the circle and ellipse are closed figures, whereas the parabola and two-part hyperbola are unbounded.*



Circle



Ellipse

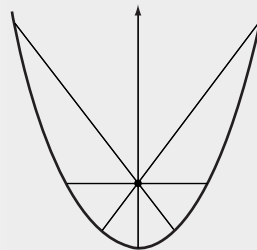

Parabola

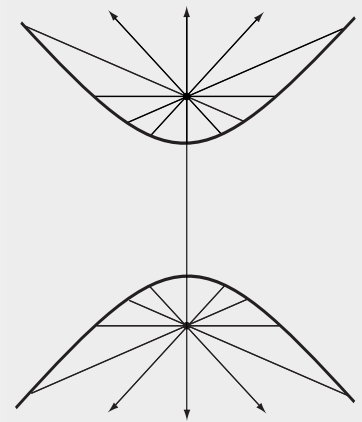

Hyperbola

at the center. Make another crease. Repeat this process around the entire circumference (approximately 25 times). At the end of this process, you will see a circle enveloped by the creases in the wax paper.

Now take another piece of wax paper and do the same thing, but this time put the point a little away from the center. At the end of this process, the creases will envelop an ellipse, with the dot being one focus. (Figure 1.9a)

Repeat this construction several times, each time moving the point a little farther away from the center of the circle. Then try it with the point outside the circle; this will generate a hyperbola. (Figure 1.9b) Then make the same construction, using a line and a point, to construct a

parabola. (Figure 1.9c)

In this way, you can construct all the conic sections as envelopes of lines. Now, think of the different curvatures involved in each conic section, and the relationship of that curvature to the position of the dot (focus).

To see this more clearly, do the following. In each of the constructions, draw a straight line from the focus to the curve. (Figure 1.10) How does the length of this line change, as it rotates around the focus? How is this change different in each curve?

Over the next several chapters, we will discover how these geometrical relationships reflect the harmonic ordering of the Universe.

—Bruce Director

CHAPTER 2

Clues from Kepler

What did Gauss do, which other astronomers and mathematicians of his time did not, and which led those others to make wildly erroneous forecasts on the path of the new planet? Perhaps we shall have to consult Gauss's great teacher, Johannes Kepler, to give us some clues to this mystery.

Gauss first of all adopted Kepler's crucial hypothesis, that the *motion of a celestial object is determined solely by its orbit*, according to the intelligible principles Kepler demonstrated to govern all known motions in the solar system. In the Keplerian determination of orbital motion, no information is required concerning mass, velocity, or any other details of the orbiting object itself. Moreover, as Gauss demonstrated, and as we shall rediscover for our-

selves, the orbit and the orbital motion in its totality, can be adduced from nothing more than the internal "curvature" of any portion of the orbit, however small.

Think this over carefully. Here, the science of Kepler, Gauss, and Riemann distinguishes itself *absolutely* from that of Galileo, Newton, Laplace, *et al.* Orbits and changes of orbit (which in turn are subsumed by higher-order orbits) are *ontologically primary*. The relation of the Keplerian orbit, as a relatively "timeless" existence, to the array of successive positions of the orbiting body, is like that of an hypothesis to its array of theorems. From this standpoint, we can say it is the orbit which "moves" the planet, not the planet which creates the orbit by its motion!

FIGURE 2.1. A set of three angles is used to specify the spatial orientation of a given Keplerian orbit relative to the orbit of the Earth. (1) Angle of inclination i , which the plane of the given orbit makes with the ecliptic plane (the plane of the Earth's orbit). (2) Angle ϕ , which the orbit's major axis makes with the "line of nodes" (the line of intersection of the plane of the given orbit and the ecliptic plane). (3) Angle ϑ , which the line of nodes makes with some fixed axis a in the ecliptic plane (the latter is generally taken to be the direction of the "vernal equinox").

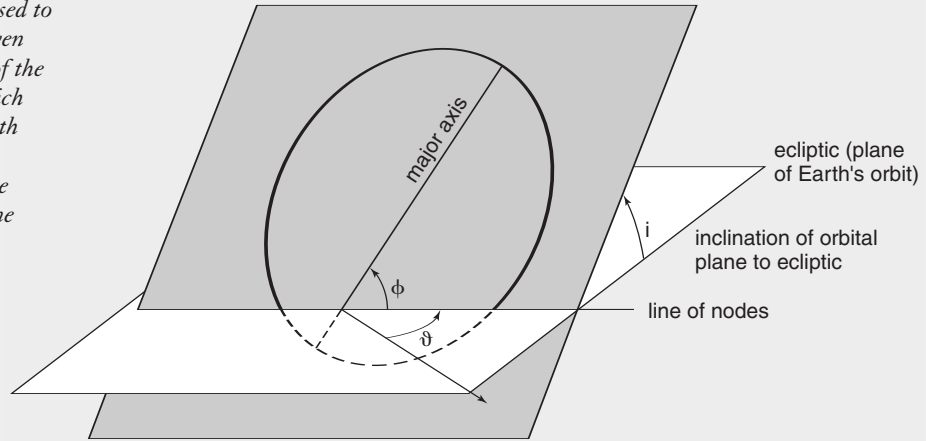

If we interfere with the motion of an orbiting object, then we are doing work against the orbit as a whole. The result is to change the orbit; and this, in turn, causes the change in the visible motion of the object, which we ascribe to our efforts. That, and not the bestial “pushing and pulling” of Sarpian-Newtonian point-mass physics, is the way our Universe works. Any competent astronaut, in order to successfully pilot a rendezvous in space, must have a sensuous grasp of these matters. Gauss’s entire method rests upon it.

Gauss adopted an additional, secondary hypothesis, likewise derived from Kepler, for which we have been prepared by Chapter 1: At least to a *very high degree of precision*, the orbit of any object which does not pass extremely close to some other body in our solar system (moons are excluded, for example), has the form of a simple conic section (a circle, an ellipse, a parabola, or a hyperbola) with focal point at the center of the sun. Under such conditions, the motion of the celestial object is *entirely determined* by a set of five parameters, known among astronomers as the “elements of the orbit,” which specify the form and position of the orbit in space. Once the “elements” of an orbit are specified, and *for as long as the object remains in the specified orbit*, its motion is entirely determined *for all past, present, and future times!*

Gauss demonstrated how the “elements” of any orbit, and thereby the orbital motion itself in its totality, can be adduced from nothing more than the curvature of any “arbitrarily small” portion of the orbit; and how the latter can in turn be adduced—in an eminently practical way—from the “intervals,” defined by only three good, closely spaced observations of apparent positions as seen from the Earth!

The ‘Elements’ of an Orbit

The *elements* of a Keplerian elliptical orbit consist of the following:

- Two parameters, determining the position of the *plane of the object’s orbit* relative to the plane of the Earth’s orbit (called the “ecliptic”). (**Figure 2.1**) Since the sun is the common focal point of both orbits, the two orbital planes intersect in a line, called the “*line of nodes*.” The relative position of the two planes is uniquely determined, once we prescribe:

- (i) their angle of inclination to each other (i.e., the angle between the planes); and

- (ii) the angle made by the line of nodes with some fixed axis in the plane of the Earth’s orbit.

- Two parameters, specifying the *shape* and *overall scale* of the object’s Keplerian orbit. (**Figure 2.2**) It is not necessary to go into this in detail now, but the chiefly employed parameters are:

- (iii) the relative scale of the orbit, as specified (for example) by its width when cut perpendicular to its major axis through the focus (i.e., center of the sun);

- (iv) a measure of shape known as the “eccentricity,” which we shall examine later, but whose value is 0 for circular orbits, between 0 and 1 for elliptical orbits, exactly 1 for parabolic orbits, and greater than 1 for hyperbolic orbits. Instead of the eccentricity, one can also use the perihelial distance, i.e., the shortest distance from the orbit to the center of the sun, or its ratio to the width parameter;

- Lastly, we have:

- (v) one parameter specifying the angle which the main axis of the object’s orbit within its own orbital plane, makes with the line of intersection with the Earth’s orbit (“line of nodes”). For this purpose, we can

FIGURE 2.2. (a) The relative scale of the orbit can be measured by the line perpendicular to the line of apsides, drawn through the focus (sun). This line is known as the “parameter” of the orbit. (b) The eccentricity is measured as the ratio of the distance f from the focus to the center of the orbit (point c , the midpoint of the major axis) divided by the semi-major axis A . For the circle, in which case the focus and center coincide, $f = 0$; for the ellipse, $0 < f/A < 1$.

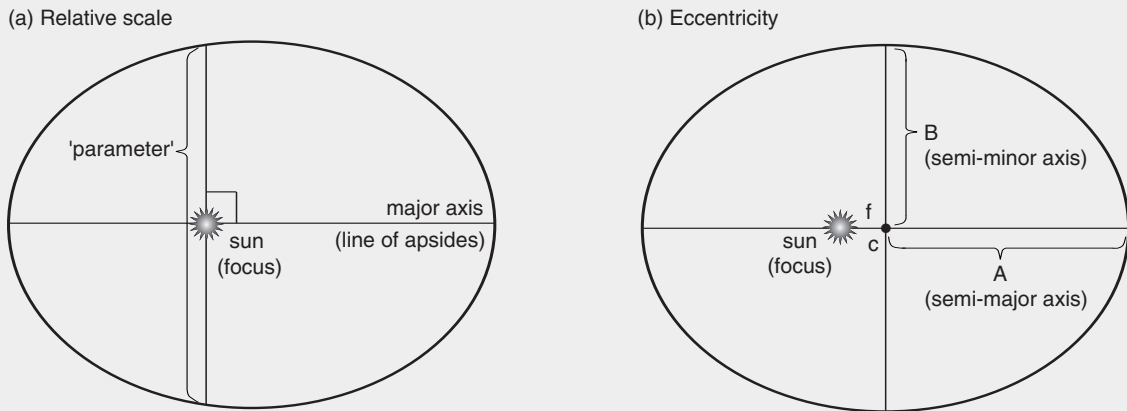

take the angle between the major axis of the object’s orbit and the line of nodes. (Figure 2.1)

The entire motion of the orbiting body is determined by these elements of the orbit alone. If you have mastered Kepler’s principles, you can compute the object’s precise position at any future or past time. All that you must know, in addition to Kepler’s laws and the five parameters just described, is a single time when the planet was (or will be) in some particular locus in the orbit, such as the perihelion position. (Sometimes, astronomers include the time of last perihelion-crossing among the “elements.”)

Now, let us go back to Fall 1801, as Gauss pondered over the problem of how to determine the orbit of the unknown object observed by Piazzi, from nothing but a handful of observations made in the weeks before it disappeared in the glare of the morning sun.

The first point to realize, of course, is that the tiny arc of a few degrees, which Piazzi’s object appeared to describe against the background of the stars, was not the real path of the object in space. Rather, the positions recorded by Piazzi were the result of a rather complicated combination of motions. Indeed, the observed motion of any celestial object, as seen from the Earth, is compounded *chiefly* from the following three processes, or degrees of action:

1. The rotation of the Earth on its axis (uniform circular rotation, period one day). (Figure 2.3)
2. The motion of the Earth in its known Keplerian orbit around the sun (non-uniform motion on an ellipse, period one year). (Figure 2.4)
3. The motion of the planet in an unknown Keplerian

orbit (non-uniform motion, period unknown in the case of an elliptical orbit, or nonexistent in case of a parabolic or hyperbolic orbit). (Figure 2.5)

Thus, when we observe the planet, what we see is a kind of blend of all of these motions, mixed or “multiplied” together in a complex manner. Within any interval of time, however short, all three degrees of action are operating *together* to produce the apparent positions of the object. As it turns out, there is no simple way to “separate out” the three degrees of motion from the observations, because (as we shall see) the exact way the three motions are combined, depends on the parameters of the unknown orbit, which is exactly what we are trying to determine! So, *from a deductive standpoint*, we would seem to be caught in a hopeless, vicious circle. We shall get back to this point later.

Although the main features of the apparent motion are produced by the “triple product” of two elliptical motion and one circular motion, as just mentioned, several other processes are also operating, which have a comparatively slight, but nevertheless distinctly measurable effect on the apparent motions. In particular, for his *precise* forecast, Gauss had to take into account the following known effects:

4. The 25,700-year cycle known as the “precession of the equinoxes,” which reflects a slow shift in the Earth’s axis of rotation over the period of observation. (Figure 2.6) The angular change of the Earth’s axis in the course of a single year, causes a shift in the apparent positions of observed objects of the order of tens of seconds of arc (depending on their inclination to the celestial equator), which is much larger than the margin of

FIGURE 2.3. *Rotation of Earth (daily).*



FIGURE 2.4. *Orbit of Earth (yearly).*

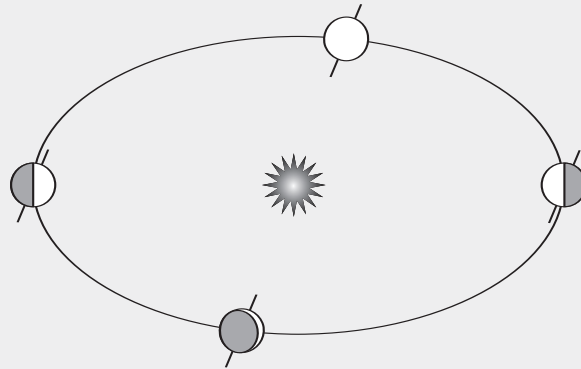

precision which Gauss required. (In Gauss's time astronomers routinely measured the apparent positions of objects in the sky to an accuracy of one second of arc, which corresponds to a 1,296,000th part of a full circle. Recall the standard angular measure: one full circle = 360 degrees; one degree = 60 minutes of arc; one minute of arc = 60 seconds of arc. Gauss is always working with parts-per-million accuracy, or better.)

5. The "nutation," which is a smaller periodic shift in the Earth's axis, superimposed on the 25,700-year precession, and chiefly connected with the orbit of the moon.
6. A slight shift of the apparent direction of a distant star or planet relative to the "true" one, called "aberration," due to the compound effect of the finite velocity of light and the velocity of the observer dur-

ing the time it takes the light to reach him.

7. The apparent positions of stars and planets, as seen from the Earth, are also significantly modified by the diffraction of light in the atmosphere, which bends the rays from the observed object, and shifts its apparent position to a greater or lesser degree, depending on its angle above the horizon. Gauss assumed that Piazzi, as an experienced astronomer, had already made the nec-

FIGURE 2.5. *Unknown orbit of "mystery planet" (period unknown).*

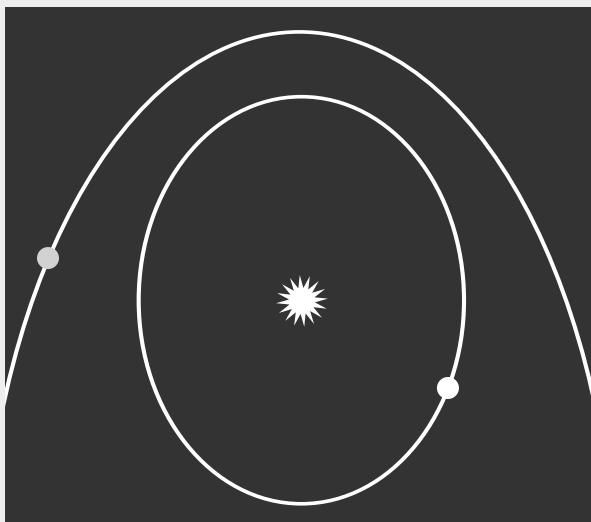
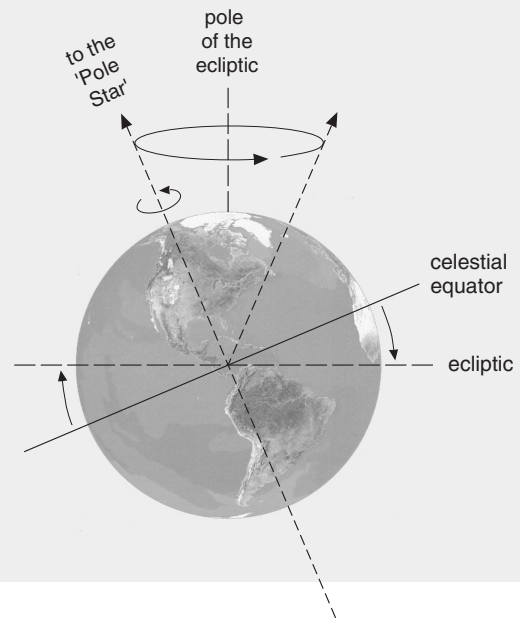

FIGURE 2.6. *Precession of the equinoxes (period 25,700 years). The "precession" appears as a gradual shift in the apparent positions of rising and setting stars on the horizon, as well as a shift in position of the celestial pole. This phenomenon arises because Earth's axis of rotation is not fixed in direction relative to its orbit and the stars, but rotates (precesses) very slowly around an imaginary axis called the "pole of the ecliptic," the direction perpendicular to the ecliptic plane (the plane of the Earth's orbit).*



essary corrections for diffraction in the reported observations. Nevertheless, Gauss naturally had to allow for a certain margin of error in Piazzi's observations, arising from the imprecision of optical instruments, in the determination of time, and other causes.

Finally, in addition to the exact times and observed positions of the object in the sky, Gauss also had to know the exact geographical position of Piazzi's observatory on the surface of the Earth.

What Did Piazzi See?

Let us assume, for the moment, that the complications introduced by effects 4, 5, 6, and 7 above are of a relatively technical nature and do not touch upon what Gauss called "the nerve of my method." Focus first on obtaining some insight into the way the three main degrees of action 1, 2, and 3 combine to yield the observed positions.

For exploratory purposes, do something like the following experiment, which requires merely a large room and tables. (Figures 2.7 and 2.8) Set up one object to represent the sun, and arrange three other objects to represent three successive positions of the Earth in its orbit around the sun. This can be done in many variations, but a reasonable first selection of the "Earth" positions would be to place them on a circle of about two meters (about 6.5 feet) radius around the "sun," and about 23 centimeters (about 9 inches) apart—corresponding, let us say, to the positions on the Sundays of three successive weeks. Now arrange another three objects at a greater distance from the "sun," for example 5 meters (16 feet), and separated from each other by, say 6 and 7 centimeters. These positions need not be exactly on a circle, but only very roughly so. They represent hypothetical positions of Piazzi's object on the same three successive Sundays of observation.

For the purpose of the sightings we now wish to make, the best choice of "celestial objects" is to use small, bright-colored spheres or beads of diameter 1 cm or less, mounted at the end of thin wooden sticks which are fixed to wooden disks or other objects, the latter serving as

bases placed on the table, as shown in the photograph in Figure 2.7.

Now, sight from each of the Earth positions to the corresponding hypothetical positions of Piazzi's object, and beyond these to a blackboard or posters hung from an opposing wall. Imagine that wall to represent part of the celestial sphere, or "sphere of fixed stars." Mark the positions on the wall which lie on the lines of sight between the three pairs of positions of the Earth and Piazzi's object. Those three marks on the wall, represent the "data" of three of Piazzi's observations, in terms of the object's apparent position relative to the background of the fixed stars, assuming the observations were made on successive Sundays. Experimenting with different relative positions of the two in their orbits, we can see how the observational phenomenon of apparent retrograde motion and "looping" can come about (in fact, Piazzi observed a retrograde motion). (Figure 2.9) Experiment also with different arrangements of the spheres representing Piazzi's object, as might correspond to different orbits.

From this kind of exploration, we are struck by an enormous apparent ambiguity in the observations. What Piazzi saw in his telescope was only a very faint point of light, hardly distinguishable from a distant star except by its motion with respect to the fixed stars from day to day.



FIGURE 2.7. Author Bruce Director demonstrates Piazzi's sightings. The models on the table in the foreground represent the three different positions of the Earth. The models on the table in front of the board represent the corresponding positions of Ceres. Marks 1, 2, and 3 on the board represent the sightings of Ceres, as seen from the corresponding positions of the Earth.

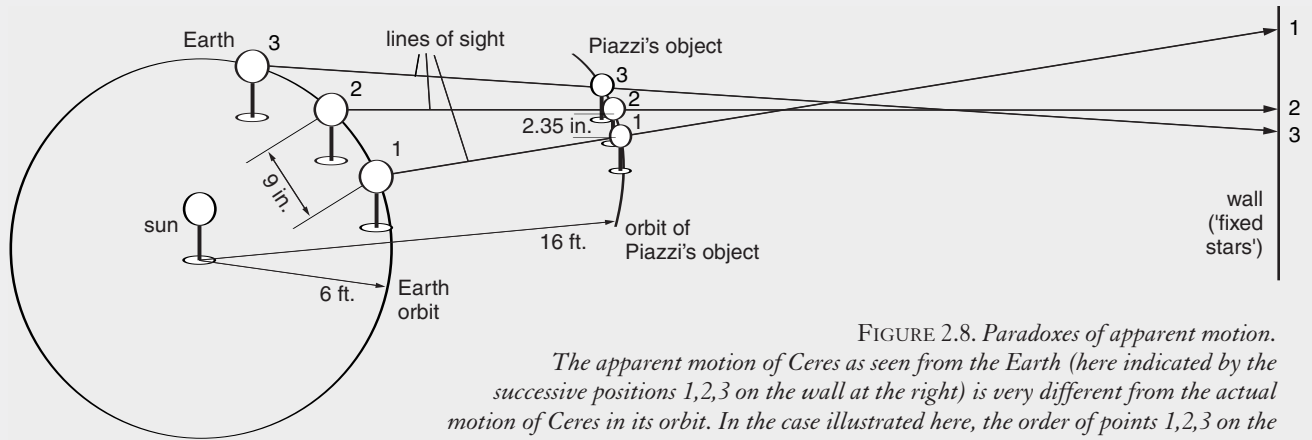

FIGURE 2.8. *Paradoxes of apparent motion.*
 The apparent motion of Ceres as seen from the Earth (here indicated by the successive positions 1,2,3 on the wall at the right) is very different from the actual motion of Ceres in its orbit. In the case illustrated here, the order of points 1,2,3 on the wall is reversed relative to Ceres' actual positions; thus, Ceres will appear from Earth to be moving backwards! The bizarre appearance of retrograde motion and "looping" is due to the differential in motion of Earth and Ceres, combined with their relative configuration in space, Earth's orbital motion being faster than that of Ceres (see Figure 2.9). In reality, the apparent motion is further complicated by the circumstance that the two bodies are orbiting in different planes.

On the face of things, there would seem to be no way to know exactly how far away the object might be, nor in what exact direction it might be moving in space. Indeed, all we really have are three straight lines-of-sight, running from each of the three positions of the Earth to the corresponding marks on the wall. For all we know, each of the three positions of Piazzi's object might be located anywhere along the corresponding line-of-sight! We do know the *time intervals* between the positions we are looking at (in this case a period of one week), but how can that help us? Those times, in and of themselves, do

not even tell us how fast the object is really moving, since it might be closer or farther away, and moving more or less toward us or away from us.

Try as we will, there seems to be no way to determine the positions in space from the observations in a deductive fashion. But haven't we forgotten what Kepler taught us, about the primacy of the *orbit*, over the motions and positions?

Gauss didn't forget, and we shall discover his solution in the coming chapters.

—Jonathan Tennenbaum

FIGURE 2.9. Star charts show apparent retrograde motion for the asteroids (a) Ceres, and (b) Pallas, during 1998.

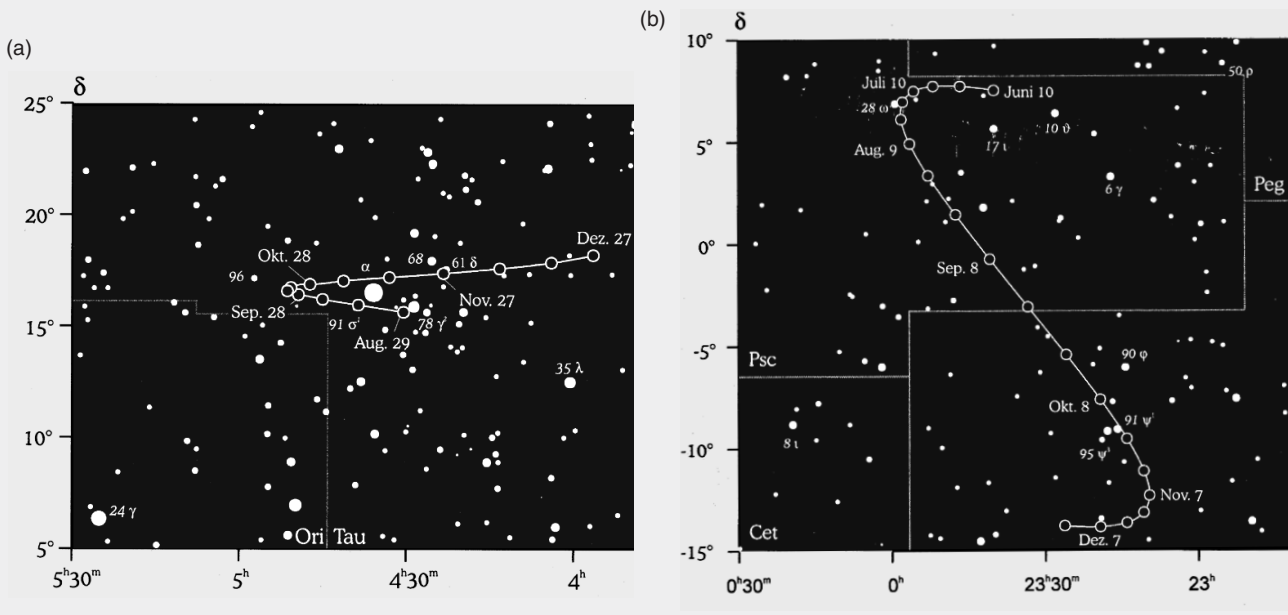

Method—Not Trial-and-Error

In investigations such as we are now pursuing, it should not be so much asked “what has occurred,” as “what has occurred that has never occurred before.”

—C. Auguste Dupin,
in Edgar Allan Poe’s
“The Murders in the Rue Morgue”

With Dupin’s words in mind, let us return to the dilemma in which we had entangled ourselves in our discussion in the previous chapter. That dilemma was connected to the fact, that what Piazzi observed as the motion of the unknown object against the fixed stars, was neither the object’s actual path in space, nor even a simple projection of that path onto the celestial sphere of the observer, but rather, the result of the motion of the object and the motion of the Earth, mixed together.

Thanks to the efforts of Kepler and his followers, the determination of the orbit of the Earth, subsuming its distance and position relative to the sun on any given day of the year, was quite precisely known by Gauss’s time. Accordingly, we can formulate the challenge posed by Piazzi’s observations in the following way: We can determine a precise set of positions in space from which

Piazzi’s observations were made, taking into account the Earth’s own motion. From each of the positions of Palermo, where Piazzi’s observatory was located, draw a straight line-of-sight in the direction in which Piazzi saw the object at that moment. All we can say with certainty about the actual positions of the unknown object at the given times, is that each position lies *somewhere* along the corresponding straight line. What shall we do?

In the face of such an apparent degree of ambiguity, any attempt to “curve fit” fails. For, there are no well-defined positions on which to “fit” an orbit! But, don’t we know *something* more, which could help us? After all, Kepler taught that the geometrical *forms* of the orbits are (to within a very high degree of precision, at least) plane conic sections, having a common focus at the center of the sun. Kepler also provided a crucial, additional set of constraints (to be examined in Chapter 7), which determine the precise motion in any given orbit, once the “elements” of the orbit discussed last chapter have been determined.

Now, unfortunately, Piazzi’s observations don’t even tell us what *plane* the orbit of Piazzi’s object lies in. How do we find the right one?

Take an arbitrary plane through the sun. The lines-of-sight of Piazzi’s observations will intersect that plane in as many points, each of which is a candidate for the position of the object at the given time. Next, try to construct a conic section, with a focus at the sun, which goes through those points or at least fits them as closely as possible. (Alas! We are back to curve-fitting!) (**Figure 3.1**)

Finally—and this is the substantial new feature—check whether the time intervals defined by a Keplerian motion along the hypothesized conic section between the given points, agree with the actual time intervals of Piazzi’s observations. If they don’t fit, which will be nearly always the case, then we reject the orbit. For example, if the intersection-points are very far away from the sun, then Kepler’s constraints would imply a very slow motion in the corresponding orbit; outside a certain distance, the corresponding time-intervals would become larger than the times between Piazzi’s actual observations. Conversely, if the points are very close to the sun, the motion would be too fast to agree with Piazzi’s times.

The consideration of time-intervals thus helps to limit the range of trial-and-error search somewhat, but the domain of apparent possibilities still remains monstrously large. With the unique exception of Gauss, astronomers

FIGURE 3.1. Piazzi’s observations define three “lines of sight” from three Earth positions E_1, E_2, E_3 , but do not tell us where the planet lies on any of those lines. We do know that the positions lie on some plane through the sun.

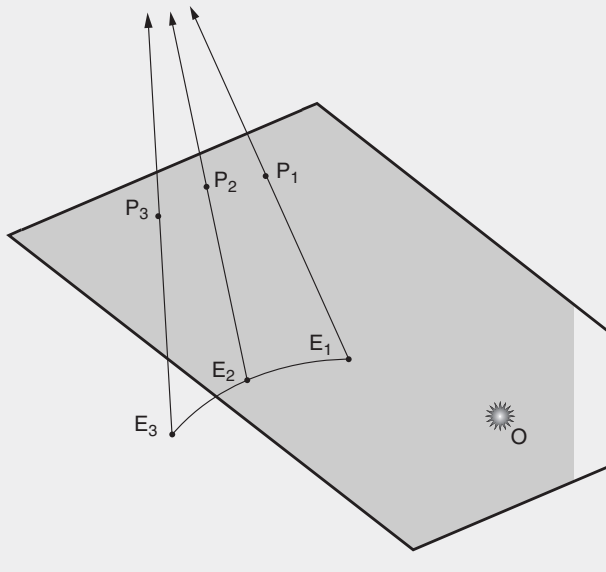

C.F. Gauss: ‘To determine the orbit of a heavenly body, without any hypothetical assumption’

It seems somewhat strange that the general problem—to determine the orbit of a heavenly body, without any hypothetical assumption, from observations not embracing a great period of time, and not allowing a selection with a view to the application of special methods—was almost wholly neglected up to the beginning of the present century; or, at least, not treated by any one in a manner worthy of its importance; since it assuredly commended itself to mathematicians by its difficulty and elegance, even if its great utility in practice were not apparent. An opinion had universally prevailed that a complete determination from observations embracing a short interval of time was impossible,—an ill-founded opinion,—for it is now clearly shown that the orbit of a heavenly body may be determined quite nearly from good observations embracing only a few days; and this without any hypothetical assumption.

Some ideas occurred to me in the month of September of the year 1801, [as I was] engaged at that time on a very different subject, which seemed to point to the solution of the great problem of which I have spoken.

Under such circumstances we not infrequently, for fear of being too much led away by an attractive investigation, suffer the associations of ideas, which, more attentively considered, might have proved most fruitful in results, to be lost from neglect. And the same fate might have befallen these conceptions, had they not happily occurred at the most propitious moment for their preservation and encouragement that could have been selected. For just about this time the report of the new planet, discovered on the first day of January of that year with the telescope at Palermo, was the subject of universal conversation; and soon afterwards the observations made by that distinguished astronomer Piazzi, from the above date to the eleventh of February were published.

Nowhere in the annals of astronomy do we meet with so great an opportunity, and a greater one could hardly be imagined, for showing most strikingly, the value of this problem, than in this crisis and urgent necessity, when all hope of discovering in the heavens this planetary atom, among innumerable small stars after the lapse

of nearly a year, rested solely upon a sufficiently approximate knowledge of its orbit to be based upon these very few observations. Could I ever have found a more seasonable opportunity to test the practical value of my conceptions, than now in employing them for the determination of the orbit of the planet Ceres, which during these forty-one days had described a geocentric arc of only three degrees, and after the lapse of a year must be looked for in a region of the heavens very remote from that in which it was last seen?

The first application of the method was made in the month of October 1801, and the first clear night (December 7, 1801), when the planet was sought for as directed by the numbers deduced from it, restored the fugitive to observation. Three other new planets subsequently discovered, furnished new opportunities for examining and verifying the efficiency and generality of the method. [*emphasis in original*]

Excerpted from the Preface to the English edition of Gauss's "Theory of the Motion of the Heavenly Bodies Moving about the Sun in Conic Sections."

felt themselves forced to make ad hoc assumptions and guesses, in order to radically reduce the range of possibilities, and thereby reduce the trial-and-error procedures to a minimum.

For example, the astronomer Wilhelm Olbers and others decided to start with the working assumption that the sought-for orbit was very nearly circular, in which case the motion becomes particularly simple. Kepler's third constraint (usually referred to as his "Third Law") determines a specific rate of uniform motion along the circle, as soon as the radius of the circular orbit is known. According to that third constraint, the square of periodic time in any closed orbit—i.e., a circular or an elliptical one—as measured in years, is equal to the cube of the orbit's major axis, as measured in units of the major axis of the Earth's orbit. Next, Olbers took **two** of Piazzi's observations, and calculated the radius which a

circular orbit would have to have, in order to fit those two observations.

It is easy to see how to do that in principle: The two observations define two lines of sight, each originating from the position of the Earth at the moment of observation. Imagine a sphere of variable radius r , centered at the sun. (**Figure 3.2**) For each choice of r , that sphere will intersect the lines-of-sight in two points, P and Q . Assuming the planet were actually moving on a circular orbit of radius r , the points P and Q would be the corresponding positions at the times of the two observations, and the orbit would be the great circle on the sphere passing through those two points. On the other hand, Kepler's constraints tell us exactly how large is the arc which any planet would traverse, during the time interval between the two observations, if its orbit were a circle of radius r . Now compare the arc determined from

FIGURE 3.2. Method to determine the orbit of Ceres, on the assumption that the orbit is circular. Two sightings of Ceres define two lines of sight coming from the Earth positions E_1 , E_2 (the Earth's positions at the moments of observation). A sphere around the sun, of radius r , intersects the lines of sight in two points P, Q , which lie on a unique great circle C on that sphere. A sphere of some different radius r' would define a different set of points P', Q' and a different hypothetical orbit C' . Determine the unique value of r , for which the size of the arc PQ agrees with the rate of motion a planet would really have, if it were moving according to Kepler's laws on the circular orbit C over the time interval between the given observations.

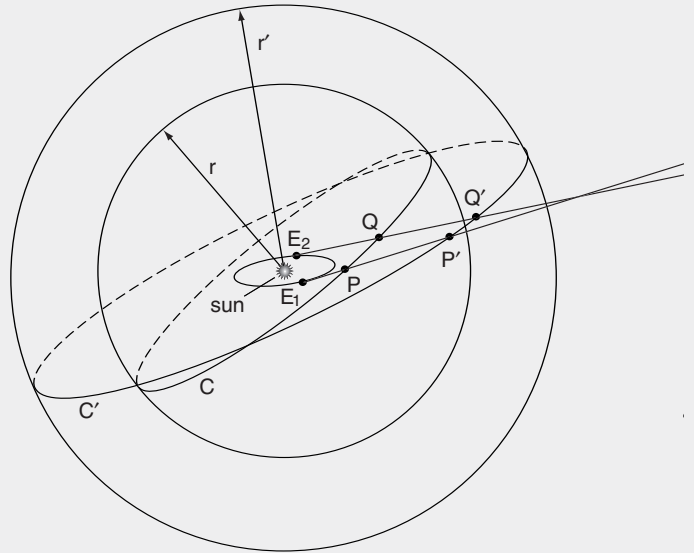

Kepler's constraint, with the actual arc between P and Q , as the length of radius r varies, and locate the value or values of r , for which the two become coincident. That determination can easily be translated into a mathematical equation whose numerical solution is not difficult to work out. Having found a circular orbit fitting two observations in that way, Olbers then used the comparison with other observations to correct the original orbit.

Toward the end of 1801 astronomers all over Europe began to search for the object Piazzi had seen in January-February, based on approximations such as Olbers'. The search was in vain! In December of that year, Gauss published his hypothesis for the orbit of Ceres, based on his own, entirely new method of calculation. According to calculations based on Gauss's elements, the object would be located more than 6° to the south of the positions forecast by Olbers, an enormous angle in astronomical terms. Shortly thereafter, the object was found very close to the position predicted by Gauss.

Characteristically, *Gauss's method used no trial-and-error at all*. Without making any assumptions on the particular form of the orbit, and using only three well-chosen observations, Gauss was able to construct a good first approximation to the orbit immediately, and then perfect it *without further observations* to a high precision, making possible the rediscovery of Piazzi's object.

To accomplish this, Gauss treated the set of observations (including the times as well as the apparent positions) as being the equivalent of a *set of harmonic intervals*. Even though the observations are, as it were, jumbled up by the effects of projection along lines-of-sight and motion of the Earth, we must start from the standpoint that the underlying curvature, determining an entire orbit from any arbitrarily small segment, is somehow

lawfully expressed in such an array of intervals. To determine the orbit of Piazzi's object, we must be able to identify the specific, tell-tale characteristics which reveal the whole orbit from, so to speak, "between the intervals" of the observations, and distinguish it from all other orbits. This requires that we conceptualize the higher curvature underlying the entire manifold of Keplerian orbits, taken as a whole. Actually, the higher curvature required, cannot be adequately expressed by the sorts of mathematical functions that existed prior to Gauss's work.

We can shed some light on these matters, by the following elementary experimental-geometrical investigation. Using the familiar nails-and-thread method, con-

FIGURE 3.3. Constructing an ellipse in the shape of the orbit of Mars.

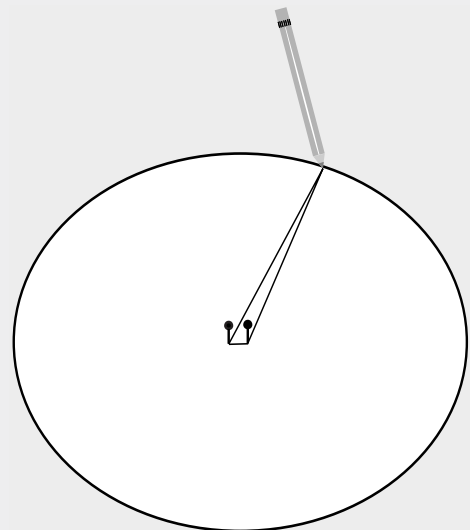

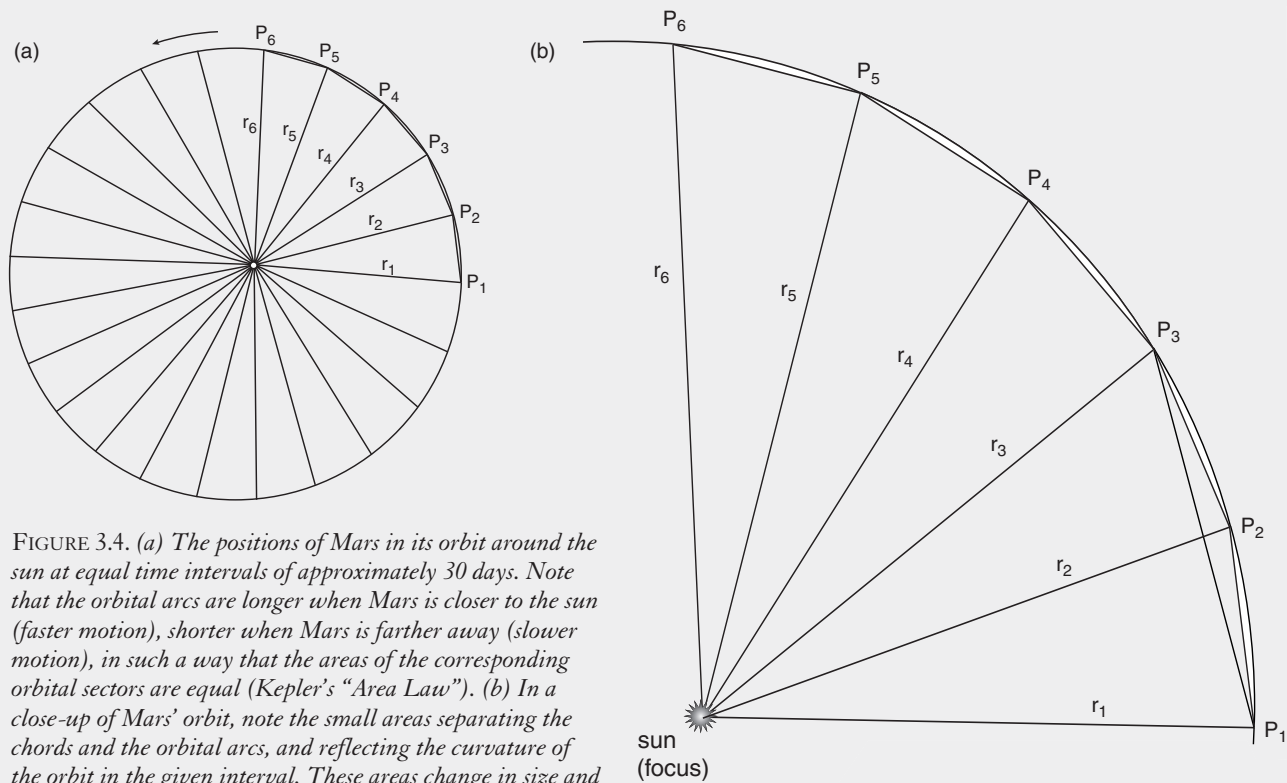

FIGURE 3.4. (a) The positions of Mars in its orbit around the sun at equal time intervals of approximately 30 days. Note that the orbital arcs are longer when Mars is closer to the sun (faster motion), shorter when Mars is farther away (slower motion), in such a way that the areas of the corresponding orbital sectors are equal (Kepler's "Area Law"). (b) In a close-up of Mars' orbit, note the small areas separating the chords and the orbital arcs, and reflecting the curvature of the orbit in the given interval. These areas change in size and shape from one part of the orbit to the next, reflecting a constantly changing curvature.

struct an ellipse having the shape of the Mars orbit, as follows. (Figure 3.3) Hammer two nails into a flat board covered with white paper, at a distance of 5.6 cm from each other. Take a piece of string 60 cm long and tie each end to one of the nails—or alternatively, make a loop of string of length $60 + 5.6 = 65.6$ cm, and loop it around both nails. Pulling the loop tight with the tip of a pencil as shown, trace an ellipse. The positions of the two nails represent the foci. The resulting curve will be a scaled-down replica of Mars' orbit, with the sun at one of the foci.

Observe that the circumference generated is hardly distinguishable, by the naked eye, from a circle. Indeed, mark the midpoint of the ellipse (which will be the point midway between the foci), and compare the distances from various points on the circumference, to the center. You will find a maximum discrepancy of only about one millimeter (more precisely, 1.3 mm), between the maximum distance (the distance between the points on the circumference at the two ends of the major axis connecting the two foci) and the minimum distance (between the endpoints of the minor axis drawn perpendicular to the major axis at its mid-point). Thus, this ellipse's deviation from a perfect circle is only on the order of four parts in one thousand. How was Kepler able to detect and demonstrate the non-circular shape of the orbit of Mars, given such a minute deviation, and how could he correct-

ly ascertain the precise nature of the non-circular form, on the basis of the technology available at his time?

Observe in Figure 3.4a, that the distances to the sun (the marked focus) change *very substantially*, as we move along the ellipse.

Now, choose two points P_1 and P_2 anywhere along the circumference of the ellipse, two centimeters apart. The interval between them would correspond to successive positions of Mars at times about seven days apart (actually, up to about 10 percent more or less than that, depending on exactly where P_1 and P_2 lie, relative to the *perihelion* [closest] and *aphelion* [farthest] positions). Draw radial lines from each of P_1, P_2 to the sun, and label the corresponding lengths r_1, r_2 .

Consider what is contained in the *curvilinear triangle* formed by those two radial line segments and the small arc of Mars' trajectory, from P_1 to P_2 . Compare that arc with that of analogous arcs at other positions on the orbit, and consider the following propositions: Apart from the symmetrical positions relative to the two axes of the ellipse, *no two such arcs are exactly superimposable in any of their parts*. Were we to change the parameters of the ellipse—for example, by changing the distance between the foci, by any amount, however small—then *none* of the arcs on the new ellipse, no matter how small, would be superimposable with *any* of those on the first, in any of

their parts! Thus, each arc is uniquely characteristic of the ellipse of which it is a part. The same is true among all species of Keplerian orbits.

Consider what means might be devised to reconstruct the whole orbit from any one such arc. For example, by what means might one determine, from a small portion of a planetary trajectory, whether it belongs to a parabolic, hyperbolic, or elliptical orbit?

Now, compare the orbital arc between P_1 and P_2 with the straight line joining P_1 and P_2 . (**Figure 3.4b**) Together they bound a tiny, virtually infinitesimal area. Evidently, the unique characteristic of the particular elliptical

orbit must be reflected somehow in the *specific manner* in which that arc *differs* from the line, as reflected in that “infinitesimal” area.

Finally, add a third point, P_3 , and consider the curvilinear triangles corresponding to each of the three pairs (P_1, P_2) , (P_2, P_3) , and (P_1, P_3) , together with the corresponding rectilinear triangles and “infinitesimal” areas which compose them. The harmonic mutual relations among these and the corresponding time intervals, lie at the heart of Gauss’s method, which is *exactly the opposite* of “linearity in the small.”

—JT

CHAPTER 4

Families of Catenaries

(An Interlude Considering Some Unexpected Facts About ‘Curvature’)

Any successful solution of the problem posed to Gauss must pivot on conceptualizing the characteristic curvature of Keplerian orbits “in the small.” Before turning to Kepler’s own investigations on this subject, it may be helpful to take a brief look at the closely related case of families of catenaries on the surface of the Earth—these being more easily accessible to direct experimentation, than the planetary orbits themselves.

Catenaries, Monads, and A First Glimpse at Modular Functions

When a flexible chain is suspended from two points, and permitted to assume its natural form under the action of its own weight, then, the portion of the chain between the two points forms a characteristic species of curve, known as a catenary. The ideal catenary is generated by a chain consisting of very small, but strong links made of a rigid material, and having very little friction; such a chain is practically inelastic (i.e., does not stretch), while at the same time being nearly perfectly flexible, down to the lower limit defined by the diameter of the individual links.

Interestingly, the form of the catenary depends only on the position of the points of suspension and the length of the chain between those points, but not on its mass or weight.

With the help of a suitable, fine-link chain, suspended parallel to, and not far from, a vertical wall or board (so

that the chain’s form can easily be seen and traced, as desired), carry out the following investigations.

(For some of these experiments, it is most convenient to use two nails or long pins, temporarily fixed into the wall or board, as suspension-points; the nails or pins should be relatively thin, and with narrow heads, so that the links of the chain can easily slip over them, in order to be able to vary the length of the suspended portion. In some experiments it is better to fix only one suspension-point with a nail, and to hold the other end in your hand.)

Start by fixing any two suspension-points and an arbitrary chain-length. (**Figure 4.1**) Observe the way the shape of each part of the catenary, so formed, depends on all the other parts. Thus, if we try to modify any portion of the catenary, by pushing it sideways or upwards with

FIGURE 4.1 A catenary is formed by suspending a chain between points A and B.

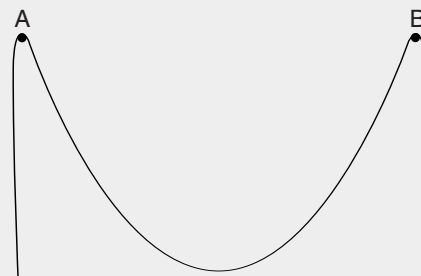
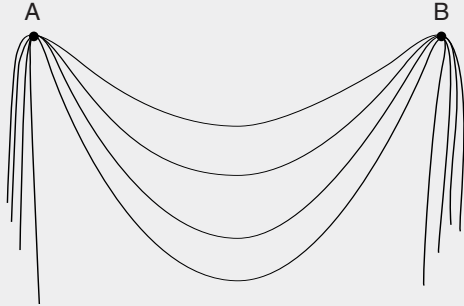

FIGURE 4.2. Varying the lengths of the chain generates a family of catenaries of varying curvatures.



the tip of a finger, we see that the entire curve is affected, at least slightly, over its entire length. This behavior of the catenary reflects Leibniz's principle of least action, whereby the entire Universe as a whole, including its most remote parts, reacts to any event anywhere in the Universe. There is no "isolated" point-to-point action in the way the Newtonians claim.

Note that the curvature of each individual catenary changes constantly along its length, as we go from its lowest point to its highest point.

Next, generate a family of catenaries, by keeping the suspension-points fixed, but varying the length of the chain between those points. (**Figure 4.2**) Observe the changes in the form and curvature, and the changes in the angles, which the chain makes to the horizontal at the points of suspension, as a function of the suspended length.

Generate a second family of catenaries, by keeping the chain length and one of the suspension-points fixed, while varying the other point. (**Figure 4.3**) If A is the first suspension-point, and L is the length of the suspended chain, then the second suspension-point B (preferably held by hand) can be located anywhere within the circle of radius L around A . For B on the circumference of the circle, the catenary degenerates into a straight line. (Or rather, something close to a straight line, since the latter would require a physically impossible, "infinite tension" to overcome the gravitational effect.) Observe the changes of form, as B moves around A in a circle of radius less than L . Also, observe the change in the angles, which the catenary makes to the horizontal at each of the endpoints, as a function of the position of B . Finally, observe the changes in the tension, which the chain exerts at the endpoint B , held by hand, as its position is changed.

Examine this second family of catenaries for the case, where the suspended length is extremely short. Combin-

FIGURE 4.3. Varying the endpoint position of a fixed length of chain generates a second family of catenaries.

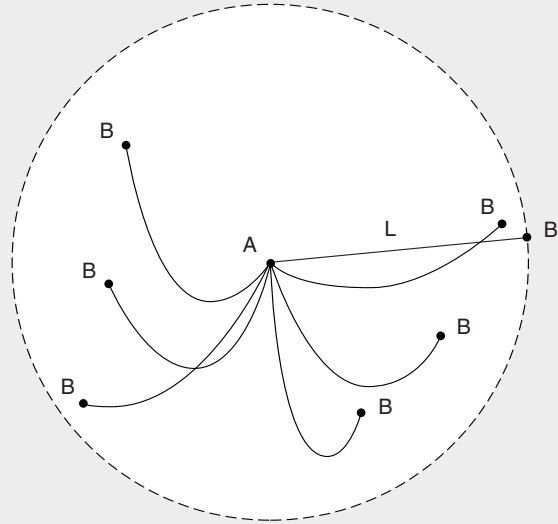
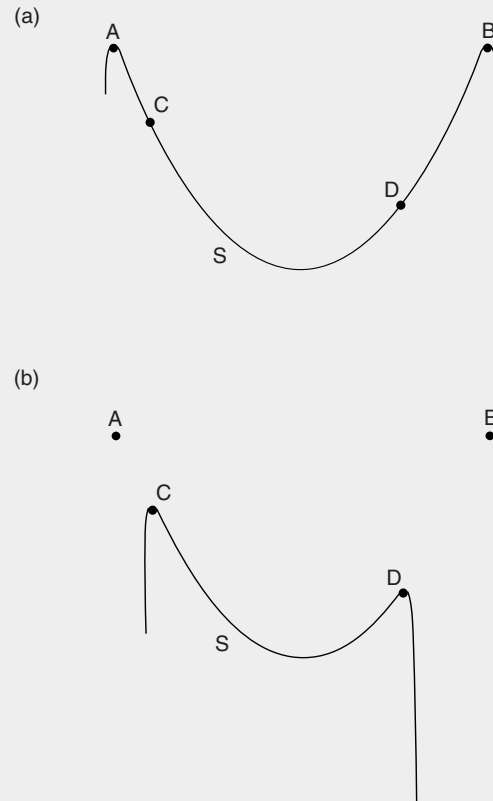

FIGURE 4.4. Release catenary AB to points C, D . Every arc of a catenary, is itself a catenary!



(families one and two) gives us the manifold of all elementary catenaries.

Consider, next, the following remarkable proposition: *Every arc of a catenary, is itself a catenary!* To wit: On a catenary with fixed suspension-points A, B , examine the arc S bounded by any two points C and D on the curve. **(Figure 4.4a)** Drive nails through the chain at C and D into the wall or board behind it. Note that the form of the chain remains unchanged. If we then remove the parts of the chain on either side of the arc, or simply release the chain from its original supports A and B , then the portion of the chain between C and D will be suspended from those points as a catenary, while still retaining the original form of the arc S . **(Figure 4.4b)**

Consider another remarkable proposition: *The entire form of a catenary (up to its suspension-points), is implicitly determined by any of its arcs, however small.* Or, to put it another way: If any arc of one catenary, however small, is congruent in size and shape to an arc on another catenary, then the two catenaries are superimposable over their *entire* lengths. (Only the endpoints might differ, as when we replaced A, B by C, D to obtain a subcatenary of an originally longer catenary.) To get some insight into the validity of this proposition, try to “beat” it by an experiment, as follows.

Fix one of the endpoints of the arc in question, say C , by a nail, and mark the position of the other endpoint, D , on the wall or board behind the chain. **(Figure 4.5)** Now taking the end of the chain on D 's side, say B , in your hand (i.e., the right-hand endpoint, if D is to the right of C , or *vice versa*), try to move that endpoint in such a way, that the corresponding catenary, whose other suspension-point is now C , always passes through the position D as verified by the mark on the adjacent wall or board. Holding to that constraint, we generate a family of catenaries having the two common points C and D . In doing so, observe that the shape of the arc between C and D continually changes, as the position of the movable endpoint B is changed. This change in shape correlates with the observation, that the tension exerted by the chain at its endpoints, changes according to their relative positions; according to the higher or lower level of tension, the arc between C and D will be less or more curved. Only a single, unique position of B (namely, the original one) produces exactly the same tension and same curvature, as the original arc CD . Our attempt to “beat” the stated proposition, fails.

While admittedly deserving more careful examination, these considerations suggest three things: Firstly, that all the catenary arcs, which are parts of one and the same catenary, share a common internal characteristic, which in turn determines the larger catenary as a

FIGURE 4.5. Only one unique position of B produces the exact tension and curvature of catenary CD . Different parts of a given catenary are local expressions of the whole, sharing a common internal characteristic.

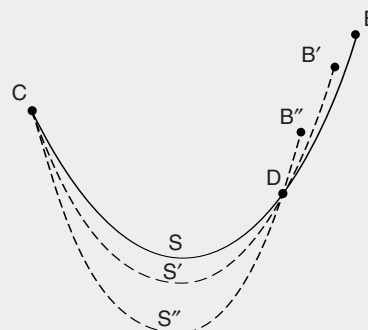

whole. In consequence of this, secondly, when we look at different parts of a given catenary, *we are in a sense looking at different local expressions on the same global entity.* Although various, small portions of the catenary have different curvatures in the sense of visual geometry, in a deeper sense they all share a common “higher curvature,” characteristic of the catenary of which they are parts. Finally, there must be a still higher mode of curvature, which defines the common characteristic of the entire family of catenaries. That latter entity would be congruent with Gauss’s concept of a modular function for the species of catenaries, as a special case of his hypergeometric function; the latter subsuming the catenaries together with the analogous, crucial features of the Keplerian planetary orbits. (In the Earth-bound case of elementary catenaries, the distinction among different catenaries is, to a very high degree of approximation, merely one of self-similar “scaling.” That is not even approximately the case for Keplerian orbits.)

In a 1691 paper on the catenary problem, Leibniz notes that Galileo had made the error of identifying the catenary with a parabola. Galileo’s error, and the discrepancy between the two curves, was demonstrated by Joachim Jungius (1585-1657) through careful, direct experiments. However, Jungius did not identify the true law underlying the catenary. Leibniz stressed, that the catenary cannot be understood in terms of the geometry we associate with Euclid, or, later, Descartes, but *is* susceptible to a *higher form of geometrical analysis*, whose principles are embodied in the so-called “infinitesimal calculus.” The latter, in turn, is Leibniz’s answer to the challenge, which Kepler threw out to the world’s geometers in his *New Astronomy (Astronomia Nova)* of 1609.

—JT

Kepler Calls for a ‘New Geometry’

Non-linear curvature, exemplified by our exploration of catenaries, stands in the forefront of Johannes Kepler’s revolutionary work *New Astronomy*. There Kepler bursts through the limitations of the Copernican heliocentric model, where the planetary orbits were assumed *a priori* to be circular.

The central paradox left by Aristarchus and Copernicus was this: Assume the motions of the planets as seen from the Earth—including the bizarre phenomena of retrograde motion—are due to the fact that the Earth is not stationary, but is itself moving in some orbit around the sun. These apparent motions result from combinations of the *unknown* true motion of the Earth and the *unknown* true motion of the heavenly bodies. How can we determine the one, without first knowing the other?

In the *New Astronomy*, Kepler recounts the exciting story, of how he was able to solve this paradox by a process of “nested triangulations,” using the orbits of Mars and the Earth. Having finally determined the precise motions of *both*, a new set of anomalies arose, leading Kepler to his astonishing discovery of the elliptical orbits and the “area law” for non-uniform motion. Kepler’s breakthrough is key to Gauss’s whole approach to the Ceres problem, one hundred fifty years later. It is therefore fitting that we examine certain of Kepler’s key steps in this and the following chapter.

As to mere shape, in fact, the orbits of the Earth, Mars, and most of the other planets (with the exception of Mercury and Pluto) are very nearly perfect circles, deviating from a perfect circular form only by a few parts in a thousand. The centers of these near-circles, on the other hand, do not coincide with the sun! Consequently, there is a constant variation in the distance between the planet and the sun in the course of an orbit, ranging between the extreme values attained at the *perihelion* (shortest distance) and the *aphelion* (farthest distance).

As Kepler noted, the perihelion and aphelion are at the same time the chief singularities of change in the planet’s rate of motion along the orbit: the maximum of velocity occurs at the perihelion, and the minimum at the aphelion.

In an attempt to account for this fact, while trying to salvage the hypothesis of simple circular motion as elementary, Ptolemy had devised his theory of the “equant.” According to that theory, the Earth is no longer the exact center of the motion, but rather another point *B*. (Figure

5.1) The planet is “driven” around its circular orbit (called an “eccentric” because of the displacement of its center from the position of the Earth) in such a way, that its *angular* motion is uniform with respect to a third point (the “equant”), located on the line of apsides opposite the Earth from the center of the eccentric circle.* In other words, the planet moves as if it were swept along the orbit by a gigantic arm, pivoted at the equant and turning around it at a constant rate.

On the basis of his precise data for Earth and Mars, Kepler was able to demolish Ptolemy’s equant once and for all. This immediately raised the question: If simple rotational action is excluded as the underlying basis for planetary motion, then what new principle of action should replace it?

Step-by-step, already beginning in the *Mysterium Cosmographicum* (*Cosmographic Mystery*), Kepler developed his “electromagnetic” conception of the solar system, referring directly to the work of the English scientist William Gilbert, and implicitly to the investigations of Leonardo da Vinci and others on light, as well as Nicolaus of Cusa. Kepler identifies the sun as the original

* Readers should remember that in Ptolemy’s astronomical model, the sun and planets are supposed to orbit about the Earth.

FIGURE 5.1. To account for the differing rates of motion of the planet, Ptolemy’s description placed the Earth at an eccentric (off-center) location, with the planet’s uniform angular motion centered at a third, “equant” point.

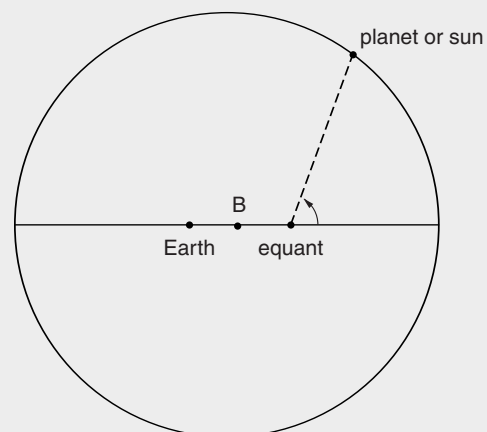

source and “organizing center” of the whole system, which is “run” on the basis of a harmonically ordered, but otherwise *constantly changing activity* of the sun vis-à-vis the planets. Kepler’s conception of that activity, has nothing to do with the axiomatic assumption of smooth, featureless, linear forms of “push-pull” displacement in empty space, promoted by Sarpi and Galileo, and revived once more in Newton’s solar theory, in which the sun is degraded to a mere “attracting center.”

On the contrary! According to Kepler, the solar activity generates a harmonically ordered, everywhere-dense array of *events of change*, whose *ongoing, cumulative result* is reflected in—among other things—the visible motion of the planets in their orbits.

The need to elaborate a new species of mathematics, able to account for the *integration* of dense singularities, emerges ever more urgently in the course of the *New Astronomy*, as Kepler investigates the revolutionary implications of his own observation, that *the rate of motion of a planet in its orbit is governed by its distance from the sun*. This relationship emerged most clearly, in comparing the motions at the perihelion and aphelion. The ratio of the corresponding velocities was found to be precisely equal to the *inverse* ratio of the two extreme radial distances. For good reasons, Kepler chose to express this, not in terms of *velocities*, but rather in terms of the *time* required for the planet to traverse a given section of its orbit.*

Kepler’s Struggle with Paradox

Let us join Kepler in his train of thought. While still operating with the approximation of a planetary orbit as an “eccentric circle,” Kepler formulates this relationship in a preliminary way as follows: It has been demonstrated,

that the elapsed times of a planet on equal parts of the eccentric circle (or equal distances in the ethereal air) are in the same ratio as the distances of those spaces from the point whence the eccentricity is reckoned [i.e., the sun–JT]; or more simply, to the extent that a planet is farther from the point which is taken as the center of the world, it is less strongly urged to move about that point.

Since the distances are constantly *changing*, the existence of such a relationship immediately raises the question: How does the temporally extended motion—as, for example, the periodic time corresponding to an entire revolution of the planet—relate to the magnitudes of those constantly varying “urges” or “impulses”?

* Cf. Fermat’s later work on least-time in the propagation of light.

FIGURE 5.2. *Kepler’s original hypothesis: The planetary orbits are circles whose centers are somewhat eccentric with regard to the sun. Kepler observed that the planet moves fastest at the perihelion, slowest at the aphelion, in apparent inverse proportion to the radial distances.*

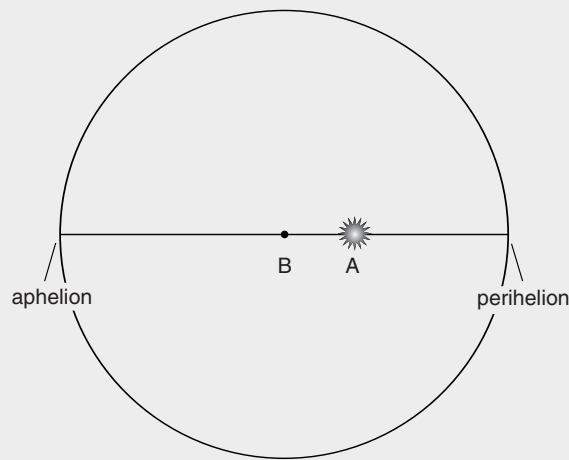

A bit later, Kepler picks up the problem again. To follow Kepler’s discussion, draw the following diagram. (Figure 5.2) Construct a circle and its diameter and label the center *B*. To the right of *B* mark another point *A*. The circumference of the circle represents the planetary orbit, and point *A* represents the position of the sun. Kepler writes:

Since, therefore, the times of a planet over equal parts of the eccentric, are to one another, as the radial distances of those parts [from the sun–JT], and since the individual points of the entire . . . eccentric are all at different distances, it was no easy task I set myself, when I sought to find how one might obtain the *sums* of the individual radial distances. For, unless we can find the sum of all of them (and they are infinite in number) we cannot say how much time has elapsed for any one of them! Thus, the whole equation will not be known. *For, the whole sum of the radial distances is, to the whole periodic time, as any partial sum of the distances is to its corresponding time.* [Emphasis added]

I consequently began by dividing the eccentric into 360 parts, as if these were least particles, and supposed that within one such part the distance does not change . . .

However, since this procedure is mechanical and tedious, and since it is impossible to compute the whole equation, given the value for one individual degree [of the eccentric–JT] without the others, I looked around for other means. Considering, that the points of the eccentric are infinite in number, and their radial lines are infinite in number, it struck me, that all the radial lines are contained within the area of the eccentric. I remembered that Archimedes, in seeking the ratio of the cir-

FIGURE 5.3. Assuming the “momentary” orbital velocities are inversely proportional to the radial distances, Kepler tries to “add up” the radii to determine how much time the planet needs to go from one point of the orbit to another.

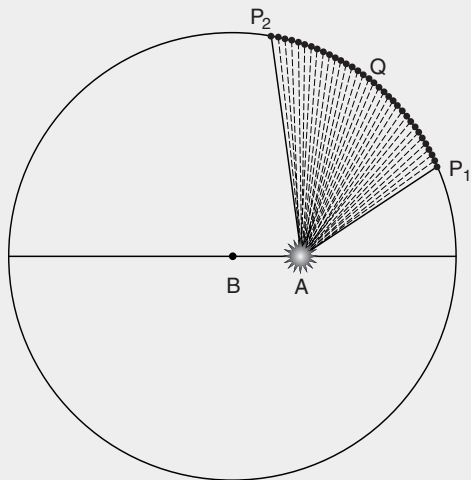

cumference to the diameter, once divided a circle thus into an infinity of triangles—this being the hidden force of his *reductio ad absurdum*. Accordingly, instead of dividing the circumference, as before, I now cut the *area* of the eccentric into 360 parts, by lines drawn from the point whence the eccentricity is reckoned [A, the position of the sun–JT]. . . .

This brief passage marks a crucial breakthrough in the *New Astronomy*. To see more clearly what Kepler has done, on the same diagram as above, mark two positions P_1, P_2 of the planet on the orbit, and draw the radial lines from the sun to those positions—i.e., AP_1 and AP_2 . (Figure 5.3) Kepler has dropped the idea of using the *length* of the arc between P_1 and P_2 as the appropriate *measure* of the action generating the orbital motion, and turned instead to the *area* of the curvilinear triangle bounded by AP_1, AP_2 and the orbital arc from P_1 to P_2 .

We shall later refer to such areas as “orbital sectors.” Kepler describes that area as the “sum” of the “infinite number” of radial lines AQ , of varying lengths, obtained as Q passes through all the positions of the planet from P_1 to P_2 ! Does he mean this literally? Or, is he not expressing, in metaphorical terms, the *coherence* between the macroscopic process, from P_1 to P_2 , and the peculiar “curvature,” which governs events within any arbitrarily small interval of that process?

The result, in any case, is a geometrical principle, which Kepler subsequently demonstrated to be empirically valid for the motion of all known planets in their orbits: *The time, which a planet takes in passing from any position P_1 to another position P_2 in its orbit, is proportional*

FIGURE 5.4. Kepler’s method for calculating the area swept out by the radial line from the sun to a planet on the assumption that the orbit is an eccentric circle, i.e., a circle whose center B is displaced from the position of the sun A .

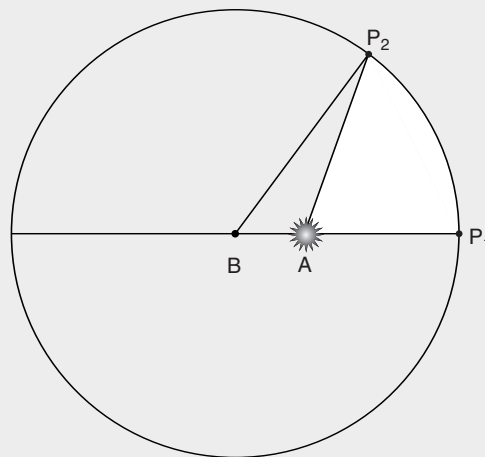

to the area of the sector bounded by the radial lines AP_1, AP_2 , and the orbital trajectory P_1P_2 , or, in other words, the area swept out by the radial line AP . This is Kepler’s famous “Second Law,” otherwise known as the “Area Law.” All that is needed in addition, to arrive at an extremely precise construction of planetary motion, is to replace the “eccentric circle” approximation, by a true ellipse, as Kepler himself does in the later sections of the *New Astronomy*. We shall attend to that in the next chapter.

Time Produced by Orbital Action?

Are you not struck by something paradoxical in Kepler’s formulation? Does he not express himself as if nearly to say, that time is *produced* by the orbital action? Or, does this only seem paradoxical to us (but not to Kepler!), because we have been indoctrinated by the kinematic conceptions of Sarpi, Descartes, and Newton?

There is another paradox implicit here, which Kepler himself emphasized. Sticking for a moment to the eccentric-circle approximation for the orbit, Kepler found a very simple way to calculate the areas of the sectors. In our earlier drawing, choose P_1 to be the intersection of the circumference and the line of apsides passing through B and A . (Figure 5.4) P_1 now represents the position of the planet at the point of perihelion. Take P_2 to be any point on the circumference in the upper half of the circle. If A and B were at the same place (i.e., if the sun were at the geometrical center of the orbit), then the sectoral area between AP_1 and AP_2 would simply be proportional to the angle formed at A between those two lines. Otherwise, we can transform

FIGURE 5.5. The swept-out area, AP_1P_2 , is equal to the circular sector P_1BP_2 , minus the triangular area AP_2B .

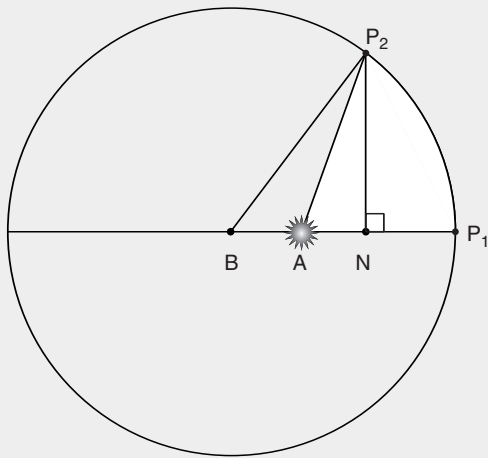

the sector in question into a simple, center-based circular sector, by *adding* to it the triangular area ABP_2 .

Indeed, as can be seen in **Figure 5.5**, the sum of the two areas is the circular sector between BP_1 and BP_2 . The area of the circular sector, on the other hand, is proportional to the angle formed by the radial lines BP_1 , BP_2 at the circle's center B , as well as to the circular arc from P_1 to P_2 . Turning this around, we can express the sector AP_1P_2 , which, according to Kepler, tells us the time elapsed between the two positions, as the result of subtracting the triangle ABP_2 from the sector BP_1P_2 . In other words: The time T to go from P_1 to P_2 , is proportional to the area AP_1P_2 , which in turn is equal to the area of the circular sector between BP_1 and BP_2 minus the area of triangle ABP_2 . Of these two areas, the first is proportional to the angle P_1BP_2 at the circle's center and to the circular arc P_1P_2 ; while the second is equal to the product of the base of triangle ABP_2 , namely the length AB , times its height. The height is the length of the perpendicular line P_2N drawn from the orbital position P_2 to the line of apsides, which (up to a factor of the radius) is just the *sine* of the angle P_1BP_2 . In this way—leaving aside, for the moment, a certain modification required by the non-circularity of the orbit—Kepler was able to calculate the elapsed times between any two positions in an orbit.

These simple relationships, which are much easier to express in geometrical drawings than in words, are crucial to the whole development up to Gauss. They involve the following peculiarity, highlighted by Kepler: The elapsed time is shown to be a combined function of the indicated *angle* or *circular arc* on the one side, and the length of the perpendicular straight line drawn from P_2 to the line of apsides, on the other. Now, as Kepler notes, *in implicit ref-*

erence to Nicolaus of Cusa, those two magnitudes are “heterogeneous”; one is essentially a curved magnitude, the other a straight, linear one. (That is, they are incommensurable; in fact, as Cusa discovered, the curve is “transcendental” to the straight line.) That heterogeneity seems to block our way, when we try to invert Kepler's solution, and to determine the position of a planet after any given elapsed time (i.e., rather than determining the time as it relates to any position). In fact, this is one of the problems which Gauss addressed with his “higher transcendents,” including the hypergeometric function.

Let us end this discussion with Kepler's own challenge to the geometers. For the present purposes—deferring some further “dimensionalities” of the problem until Chapter 6—you can read Kepler's technical terms in the following quote in the following way. What Kepler calls the “mean anomaly,” is essentially the elapsed time; the term, “eccentric anomaly,” refers to the angle subtended by the planetary positions P_1 , P_2 as seen from the center B of the circle—i.e., the angle P_1BP_2 . Here is Kepler:

But given the mean anomaly, there is no geometrical method of proceeding to the eccentric anomaly. For, the mean anomaly is composed of two areas, a sector and a triangle. And while the former is measured by the arc of the eccentric, the latter is measured by the sine of that arc. . . . And the ratios between the arcs and their sines are infinite in number [i.e., they are incommensurable as functional “species”—ed.]. So, when we begin with the sum of the two, we cannot say how great the arc is, and how great its sine, corresponding to the sum, unless we were previously to investigate the area resulting from a given arc; that is, unless you were to have constructed tables and to have worked from them subsequently.

That is my opinion. And insofar as it is seen to lack geometrical beauty, I exhort the geometers to solve me this problem:

Given the area of a part of a semicircle and a point on the diameter, to find the arc and the angle at that point, the sides of which angle, and which arc, encloses the given area. Or, to cut the area of a semicircle in a given ratio from any given point on the diameter.

It is enough for me to believe that I could not solve this, *a priori*, owing to the heterogeneity of the arc and sine. Anyone who shows me my error and points the way will be for me the great Apollonius.*

—JT

* Apollonius of Perga (c. 262-200 B.C.), Greek geometer, author of *On Conic Sections*, the definitive Classical treatise. Drawn by the reputation of the astronomer Aristarchus of Samos, he lived and worked at Alexandria, the great center of learning of the Hellenistic world, where he studied under the successors of Euclid. SEE article, page 100, this issue.—Ed.

Uniting Beauty and Necessity

A great crisis and a great opportunity were created by Giuseppe Piazzi's startling observations of a new object in the sky, in the early days of 1801. Astronomers were now forced to confront the problem of determining the orbit of a planet from only a few observations. Before Piazzi's discovery, C.F. Gauss had considered this problem purely for its intellectual beauty, although anticipating its eventual practical necessity. Others, mired in purely practical considerations, ignored Beauty's call, only to be caught wide-eyed and scrambling when presented with the news from Piazzi's observatory in Palermo. Gauss alone had the capacity to unite Beauty with Necessity, lest humanity lose sight of the newly expanded Universe.

As we continue along the circuitous path to rediscovering Gauss's method for determining the orbit of Ceres, we are compelled to linger a little longer at the beginning of an earlier century, when a great crisis and opportunity arose in the mind of someone courageous and moral enough to recognize its existence. In those early years of the Seventeenth century, as Europe disintegrated into the abyss of the Thirty Years War, Johannes Kepler's quest for beauty led him to the discoveries that anticipated the crisis Gauss would later face, and laid the groundwork for its ultimate solution.

In the last chapter, we retraced the first part of Kepler's great discoveries: that the time which a planet takes to pass from one position of its orbit to another, is proportional to the area of the sector formed by the lines joining each of those two planetary positions with the sun, and the arc of the orbit between the two points.* But, this discovery of Kepler was immediately thrown into crisis when he compared his calculations to the observed positions of Mars, and the time elapsed between those observations. This combination of the change in the observed position and the time elapsed, is a reflection of the *curvature* of the orbit. Kepler had assumed that the planets orbited the sun in eccentric circles. If, however, the planet were moving on an arc that is not circular, it could be observed in the same positions, but the elapsed time between observations

would be different than if it were moving on an eccentric circle. When Kepler calculated his new principle using different observations of the planet Mars, the results were not consistent with a circular planetary orbit.

Kepler's Account

The following extracts from Kepler's *New Astronomy* trace his thinking as he discovers his next principle. Uniquely, Kepler left us with a subjective account of his discovery. Speaking across the centuries, Kepler provides an important lesson for today's "Baby Boomers," who, so lacking the *agapē* to face a problem and discover a creative solution, desperately need the benefit of Kepler's honest discussion of his own mental struggle.

You see, my thoughtful and intelligent reader, that the opinion of a perfect eccentric circle drags many incredible things into physical theories. This is not, indeed, because it makes the solar diameter an indicator for the planetary mind, for this opinion will perhaps turn out to be closest to the truth, but because it ascribes incredible facilities to the mover, both mental and animal.

Although our theories are not yet complete and perfect, they are nearly so, and in particular are suitable for the motion of the sun, so we shall pass on to quantitative consideration.

It was in the "nearly so," the infinitesimal, that Kepler's crisis arose. He continues, a few chapters later:

You have just seen, reader, that we have to start anew. For you can perceive that three eccentric positions of Mars and the same number of distances from the sun, when the law of the circle is applied to them, reject the aphelion found above (with little uncertainty). This is the source of our suspicion that the planet's path is not a circle.

Having come to the realization that he must abandon the hypothesis of circular orbits, he first considers ovals.

Clearly, then, the orbit of the planet is not a circle, but comes in gradually on both sides and returns again to the circle's distance at perigee. One is accustomed to call the shape of this sort of path "oval."

Yet, after much work, Kepler had to admit that this too was incorrect:

When I was first informed in this manner by [Tycho] Brahe's most certain observations that the orbit of the planet is not exactly circular, but is deficient at the sides, I judged

* This principle has now become known as Kepler's Second Law, even though it was the first of Kepler's so-called three laws to be discovered. Kepler never categorized his discoveries of principles into a numbered series of laws. The codification of Kepler's discovery, to fit academically acceptable Aristotelean categories, has masked the true nature of Kepler's discovery and undermined the ability of others to know Kepler's principles, by rediscovering them for themselves.

that I also knew the natural cause of the deflection from its footprints. For I had worked very hard on that subject in Chapter 39. . . . In that chapter I ascribed the cause of the eccentricity to a certain power which is in the body of the planet. It therefore follows that the cause of this deflecting from the eccentric circle should also be ascribed to the same body of the planet. But then what they say in the proverb—“A hasty dog bears blind pups”—happened to me. For, in Chapter 39, I worked very energetically on the question of why I could not give a sufficiently probable cause for a perfect circle’s resulting from the orbit of a planet, as some absurdities would always have to be attributed to the power which has its seat in the planet’s body. Now, having seen from the observations that the planet’s orbit is not perfectly circular, I immediately succumbed to this great persuasive impetus. . . .

Self-consciously describing the emotions involved:

And we, good reader, can fairly indulge in so splendid a triumph for a little while (for the following five chapters, that is), repressing the rumors of renewed rebellion, lest its splendor die before we shall go through it in the proper time and order. You are merry indeed now, but I was straining and gnashing my teeth.

And, continuing:

While I am thus celebrating a triumph over the motions of Mars, and fetter him in the prison of tables and the leg-irons of eccentric equations, considering him utterly defeated, it is announced again in various places that the victory is futile, and war is breaking out again with full force. For while the enemy was in the house as a captive, and hence lightly esteemed, he burst all the chains of the equations and broke out of the prison of the tables. That is, no method administered geometrically under the direction of the opinion of Chapter 45 was able to emulate in numerical accuracy the vicarious hypotheses of Chapter 16 (which has true equations derived from false causes). Outdoors, meanwhile, spies positioned throughout the whole circuit of the eccentric—I mean the true distances—have overthrown my entire supply of physical causes called forth from Chapter 45, and have shaken off their yoke, retaking their liberty. And now there is not much to prevent the fugitive enemy’s joining forces with his fellow rebels and reducing me to desperation, unless I send new reinforcements of physical reasoning in a hurry to the scattered troops and old stragglers, and, informed with all diligence, stick to the trail without delay in the direction whither the captive has fled. In the following chapters, I shall be telling of both these campaigns in the order in which they were waged.

In another place, Kepler writes:

*“Galatea seeks me mischievously, the lusty wench,
She flees the willows, but hopes I’ll see her first.”*

It is perfectly fitting that I borrow Virgil’s voice to

sing this about Nature. For the closer the approach to her, the more petulant her games become, and the more she again and again sneaks out of the seeker’s grasp, just when he is about to seize her through some circuitous route. Nevertheless, she never ceases to invite me to seize her, as though delighting in my mistakes.

Throughout this entire work, my aim has been to find a physical hypothesis that not only will produce distances in agreement with those observed, but also, and at the same time, sound equations, which hitherto we have been driven to borrow from the vicarious hypothesis of Chapter 16. . . .

And, after much work, he finally arrives at the answer the Universe has been telling him all along:

The greatest scruple by far, however, was that, despite my considering and searching about almost to the point of insanity, I could not discover why the planet, to which a reciprocation LE on the diameter LK was attributed with such probability, and by so perfect an agreement with the observed distances, would rather follow an elliptical path, as shown by the equations. O ridiculous me! To think that reciprocation on the diameter could not be the way to the ellipse! So it came to me as no small revelation that through the reciprocation an ellipse was generated. . . .

With the discovery of an additional principle, Kepler has accomplished the next crucial step along the road Gauss would later extend by the determination of the orbit of Ceres. The discovery that the shape of the orbit of the planet Mars (later generalized to all planets) was an ellipse, would be later generalized even further to include all conic sections, when other heavenly bodies, such as comets, were taken into account.

But now a new crisis developed for Kepler. What we discussed in the last chapter—the elegant way of calculating the area of the orbital sector, which is proportional to the elapsed time—no longer works for an ellipse. For that method was discovered when Kepler was still assuming the shape of the planet’s orbit to be a circle.

To grasp this distinction, the reader will have to make the following drawings:

First re-draw Figure 5.5. (**Figure 6.1**) [For the reader’s convenience, figures from previous chapters are displayed again when re-introduced.]

The determination of the area formed by the motion of the planet in a given interval of time, was defined as the “sum” of the infinite number of radial lines obtained as the planet moves from P_1 to P_2 . This “sum,” which Kepler represents by the area AP_1P_2 , is calculated by subtracting the area of the triangle ABP_2 from the circular sector BP_1P_2 . But, as noted previously, determining the area of triangle ABP_2 depended on the sine of the angle ABP_2 , i.e., P_2N , which Kepler, as a student of Cusa, recognized was transcendental to the arc P_1P_2 , thus making

FIGURE 6.1. Kepler's method of calculating swept-out areas for an eccentric circular orbit.

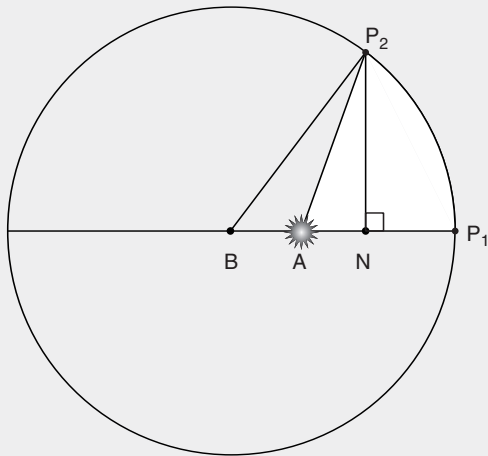

a direct algebraic calculation impossible.

But now that Kepler has abandoned the circular orbit for an elliptical one, this problem is compounded. For the circular arc is characterized by constant uniform curvature, while the curvature of the ellipse is non-uniform, constantly changing. Thus, if we abandon the circular orbit and accept the elliptical one, as reality demands, the simplicity of the method for determining the area of the orbital sector disappears.

A Dilemma, and a Solution

What a dilemma! Our Reason, following Kepler, leads us to the hypothesis that the area of the orbital sector swept out by the planet, is proportional to the time it takes for the planet to move through that section of its orbit. But, following Kepler, our Reason, guided by the actual observations of planetary orbits, also leads us to abandon the circular shape of the orbit, in favor of the ellipse, and to lose the elegant means for applying the first discovery.

This is no time to emulate Hamlet. Our only way out is to forge ahead to new discoveries. As has been the case so far, Kepler does not let us down.

For the next step, the reader will have to draw another diagram. **(Figure 6.2)** This time draw an ellipse, and call the center of the ellipse B and the focus to the right of the center A . Call the point where the major axis intersects the circumference of the ellipse closest to A , point P_1 . Mark another point on the circumference of the ellipse (moving counter-clockwise from P_1), point P_2 . As in the previous diagram, A represents the position of the sun, P_1 and P_2 represent positions of the planet at two different

FIGURE 6.2. Kepler's elliptical orbit hypothesis. Here, length P_2B is not constant, but constantly changing at a changing rate. What lawful process now underlies the generation of swept-out areas?

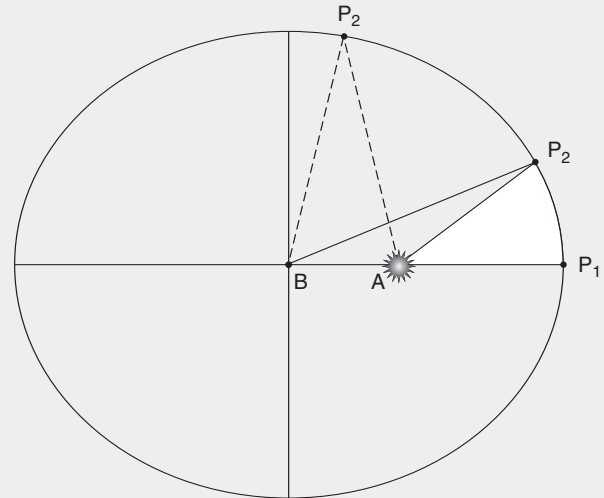

points in time, and the circumference of the ellipse represents the orbital path of the planet.

Now compare the shape of the orbital sector in the two different orbital paths, circular and elliptical, as shown in Figures 6.1 and 6.2. The difference in the *type* of curvature between the two is reflected in the *type* of change in triangle ABP_2 as the position P_2 changes. In the circular orbit, the length of line P_2A changes, but the length of line P_2B , being a radius of the circle, remains the same. In the elliptical orbit, the length of the line P_2B also changes. In fact, the rate of change of the length of line P_2B is itself constantly changing.

To solve this problem, Kepler discovers the following relationship. Draw a circle around the ellipse, with the center at B and the radius equal to the semi-major axis. **(Figure 6.3b)** This circle circumscribes the ellipse, touching it at the aphelion and perihelion points of the orbit. Now draw a perpendicular from P_2 to the major axis, striking that axis at a point N , and extend the perpendicular outward until it intersects the circle, at some point Q . Recall one of the characteristics of the ellipse (Figure 1.7b): An ellipse results from “contracting” the circle in the direction perpendicular to the major axis according to some fixed ratio. In other words, the ratio $NP_2:NQ$ has the same constant value for all positions of P_2 . Or, said inversely, the circle results from “stretching” the ellipse outward from the major axis by a certain constant factor, as if on a pulled rubber sheet. It is easy to see that the value of that factor must be the ratio of the major to minor axes of the ellipse.

FIGURE 6.3. *Ironies of Keplerian motion.* (a) M is the position a planet would reach after a given elapsed time, assuming it started at P_1 and travelled on the circular orbit with the sun at the center B . (b) P is the corresponding position on the elliptical orbit with the sun at the focus A . The orbital period is the same as (a), but the arc lengths travelled vary with the changing distance of the planet from the sun (Kepler's "area law"). Q is the position the planet would reach if it were moving on the circle, but with the sun at A rather than the center B . For equal times, the area P_1MB will be equal to area P_1QA , the latter being in a constant ratio to the area P_1P_2A .

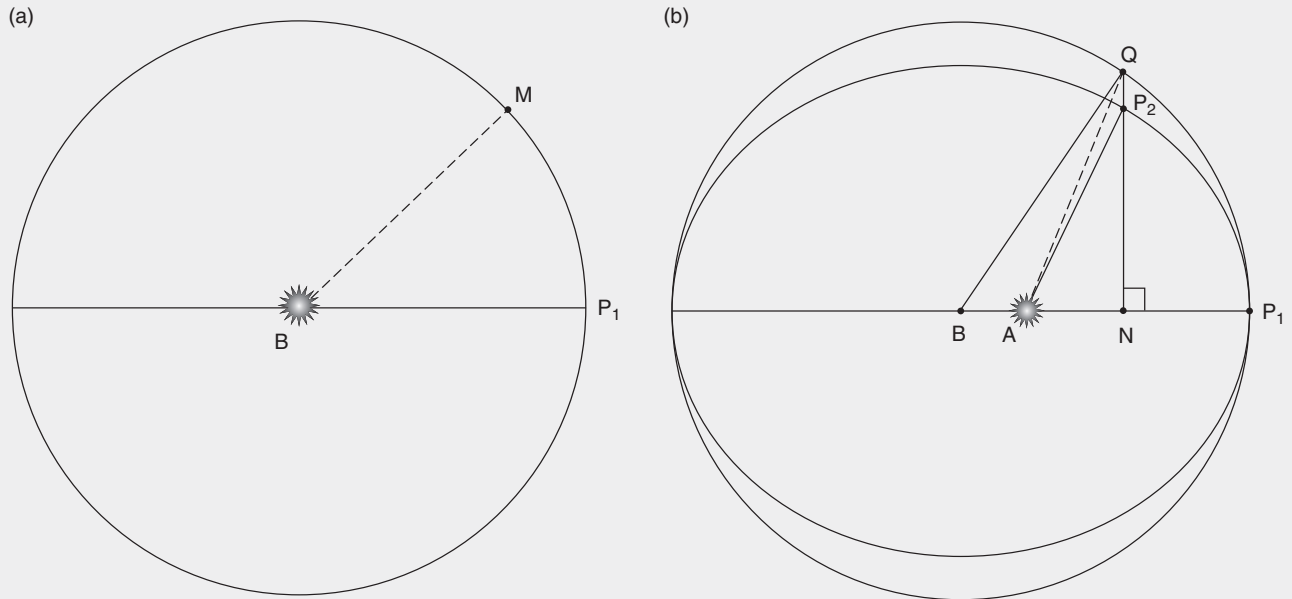

With a bit of thought, it might occur to us that the result of such "stretching" will be to change all *areas* in the figure by the same factor. Look at Figure 6.3b from that standpoint. What happens to the *elliptic sector* which we are interested in, namely P_1P_2A , when we stretch out the ellipse in the indicated fashion? It turns into the *circular sector* P_1QA ! Accordingly, the area of the elliptical sector swept out by P_2 , and that swept out on the circle by Q , stay in a constant ratio to each other throughout the motion of P_2 . Since the planet (or rather, the radial line AP_2) sweeps out equal areas on the ellipse in equal times, in accordance with Kepler's "area law," the corresponding point Q (and radial line AQ) will do the same thing on the circle.

This crucial insight by Kepler unlocks the whole problem. First, it shows that Q is just the position which the planet would occupy, were it moving on an eccentric-circular orbit in accordance with the "area law," as Kepler had originally believed. The difference in position between Q and the actual position P_2 (as observed, for example, from the sun) reflects the non-circular nature of the actual orbit. Second, the constant proportionality of the swept-out areas permits Kepler to reduce the problem of calculating the motion on the ellipse, to that of the eccentric circle, whose solution he has already obtained. (SEE Chapter 5)

Further details of Kepler's calculations need not concern us here. What is most important to recognize, is the

triple nature of the deviation of a real planet's motion from the hypothetical case of perfect circular motion with the sun at the center—a deviation which Kepler measured in terms of three special angles, called "*anomalies*." First, the sun is not at the center. Second, the orbit is not circular, but elliptical. Third, the speed of the planet varies, depending upon the planet's distance from the sun. For which reason, Kepler's approach implies reconceptualizing, from a higher standpoint, what we mean by the "curvature" of the orbit. Rather than being thought of merely as a geometrical "shape," on which the planet's motion appears to be non-uniform, the "curvature" must instead be conceived of as the motion of the planet moving along the curve *in time*—that is, we must introduce a new conception of *physical space-time*.

In a purely circular orbit, the uniformity of the planet's spatial and temporal motions coincide. That is, the planet sweeps out equal arcs and equal areas in equal times as it moves. Such motion can be completely represented by a single angular measurement.

In true elliptical orbits, however, the motion of the planet can only be completely described by a combination of three angular measurements, which are the three anomalies described below. The uniformity of the "curvature" of the planet's motion finds expression in Kepler's equal-area principle, from the more advanced *physical space-time* standpoint.

FIGURE 6.4. Non-uniform motion in an elliptical orbit is characterized by the “polyphonic” relationship between the “eccentric anomaly” (angle E), “true anomaly” (angle T), and “mean anomaly” (angle F). (a) As the planet moves from perihelion to aphelion, the true anomaly is greater than the eccentric, which is greater than the mean. (b) After the planet passes aphelion, these relationships are reversed.

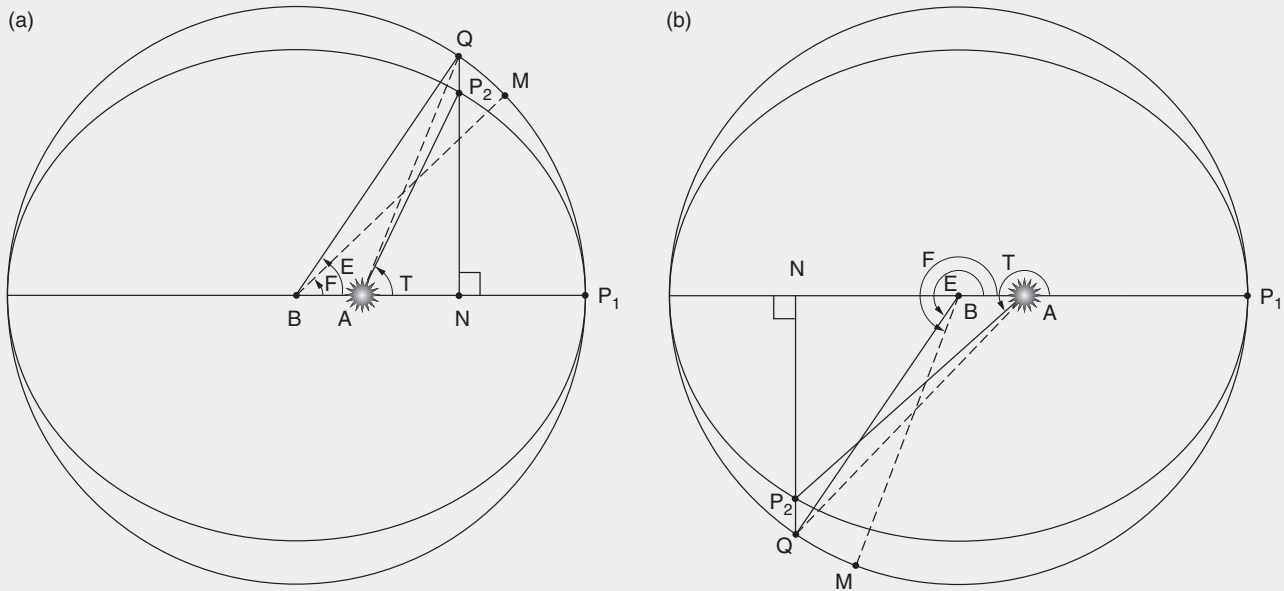

Kepler’s conception follows directly from the approach to experimental physics established by his philosophical mentor Nicolaus of Cusa. This may rankle the modern reader, whose thinking has been shaped by Immanuel Kant’s neo-Aristotelean conceptions of space and time. Kant considered three-dimensional “Euclidean” space, and a linear extension of time, to be a true reflection of reality. Gauss rejected Kant’s view, calling it an illusion, and insisting instead that the true nature of space-time can not be assumed *a priori* from purely mathematical considerations, but must be determined from the physical reality of the Universe.

Kepler’s Three Anomalies

The first anomaly is the angle formed by a line drawn from the sun to the planet, and the line of apsides (P_2AP_1 in Figure 6.3b). Kepler called this angle the “equated anomaly.” In Gauss’s time it was called the “true anomaly.” The true anomaly measures the true displacement along the elliptical orbit. The next two anomalies can be considered as two different “projections,” so to speak, of the true anomaly.

The second anomaly, called the “eccentric anomaly,” is the angle QBP_1 , which measures the area swept out had the planet moved on a circular arc, rather than an elliptical one. Since this area is proportional to the time elapsed, it is also proportional, although obviously not equal, to the true orbital sector swept out by the planet.

The third anomaly, called the “mean anomaly,” corresponds to the elapsed time, as measured either by area AP_1P_2 or by AP_1Q . It can be usefully represented by the position and angle F at B formed by an *imaginary point M* moving on the circle, whose motion is that which a hypothetical planet would have, if its orbit were the circle and if the sun were at center B rather than A ! (Figure 6.4) As a consequence of Kepler’s Third Law, the total period of the imaginary orbit of M , will coincide with that of the real planet. Hence, if M is taken to be “synchronized” in such a way that the positions of M and the actual planet coincide at the perihelion point P_1 , then M and the planet will return to that same point simultaneously after having completed one full orbital cycle.

Kepler established a relationship between the mean and eccentric anomalies, such that, given the eccentric, the mean can be approximately calculated. The inverse problem—that is, given the time elapsed, to calculate the eccentric anomaly—proved much more difficult, and formed part of the considerations provoking G.W. Leibniz to develop the calculus.

The relationship among these three anomalies is a reflection of the *curvature* of space-time relevant to the harmonic motion of the planet’s orbit, just as the catenary function described in Chapter 4, reflects such a physical principle in the gravitational field of the Earth. This threefold relationship is one of the earliest examples of what Gauss and Bernhard Riemann would later develop into *hypergeometric*, or *modular functions*—functions in which several seemingly

incommensurable cycles are unified into a One.

Kepler describes the relationship between these anomalies this way (we have changed Kepler's labelling to correspond to our diagram):

The terms "mean anomaly," "eccentric anomaly," and "equated anomaly" will be more peculiar to me. The mean anomaly is the time, arbitrarily designated, and its measure, the area P_1QA . The eccentric anomaly is the planet's path from apogee, that is, the arc of the ellipse P_1P_2 , and the arc P_1Q which defines it. The equated anomaly is the apparent magnitude of the arc P_1Q as viewed from A , that is, the angle P_1AP_2 .

All three anomalies are zero at perihelion. As the

planet moves toward aphelion, all three anomalies increase, with the true always being greater than the eccentric, which in turn is always greater than the mean. At aphelion, all three come together again, equaling 180° . As the planet moves back to perihelion, this is reversed, with the mean being greater than the eccentric, which in turn is greater than the true, until all three come back together again at the perihelion.

Suffice it to say, for now, that Gauss's ability to "read between the anomalies," so to speak, was a crucial part of his ability to hear the new polyphonies sounded by Piazzi's discovery—the unheard polyphonies that the ancient Greeks called the "music of the spheres."

—BD

CHAPTER 7

Kepler's 'Harmonic Ordering' Of the Solar System

At this point in our journey toward Gauss's determination of the orbit of Ceres, before plunging into the thick of the problem, it will be worthwhile to look ahead a bit, and to take note of a crucial

irony embedded in Gauss's use of a generalized form of Kepler's "Three Laws" for the motion of heavenly bodies in conic-section orbits.

On the one hand, we have the *harmonic ordering* of the solar system as a whole, whose essential idea is put forward by Plato in the *Timaeus*, and demonstrated by Kepler in detail in his *Mysterium Cosmographicum* (*Cosmographic Mystery*) and *Harmonice Mundi* (*The Harmony of the World*). (Figure 7.1a) A crucial feature of that ordering, already noted by Kepler, is the existence of a singular, "dissonant" orbital region, located between Mars and Jupiter—a feature whose decisive confirmation was first made possible by Gauss's determination of the orbit of Ceres. (Figure 7.1b)

Although Kepler's work in this direction is incomplete in several respects, that harmonic ordering *in principle* determines not only which orbits or arrays of planetary orbits are possible, but also the *physical characteristics* of the planets to be found in the various orbits. Thus, the Keplerian ordering of the solar system is not only *analogous* to Mendeleev's natural system of the chemical elements, but ultimately expresses the *same* underlying curvature of the Universe, manifested in the astrophysical and microphysical scales.*

On the other hand, we have Kepler's constraints for the motion of the planets within their orbits, developed step-by-step in the course of his *New Astronomy* (1609), *Harmony of the World* (1619), and *Epitome Astronomiae Copernicanae* (*Epitome of Copernican Astronomy*) (1621).

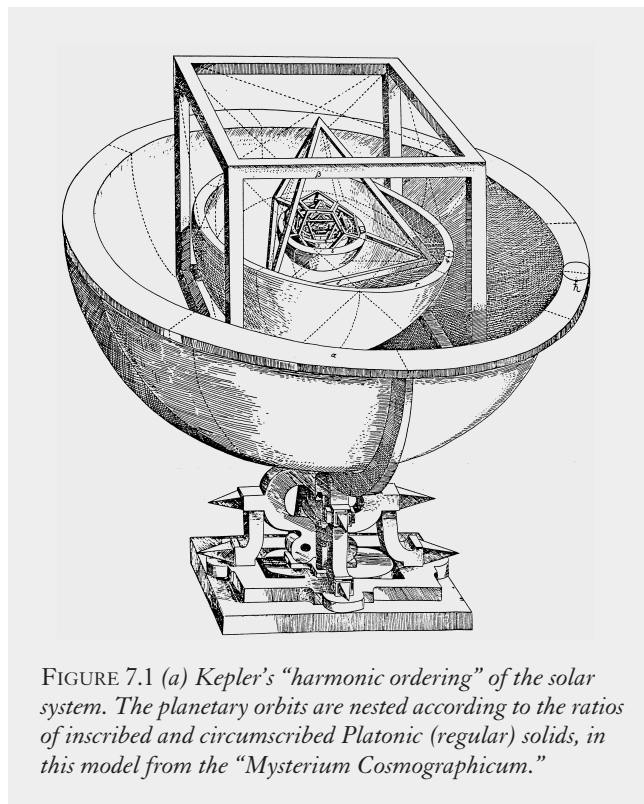

FIGURE 7.1 (a) Kepler's "harmonic ordering" of the solar system. The planetary orbits are nested according to the ratios of inscribed and circumscribed Platonic (regular) solids, in this model from the "Mysterium Cosmographicum."

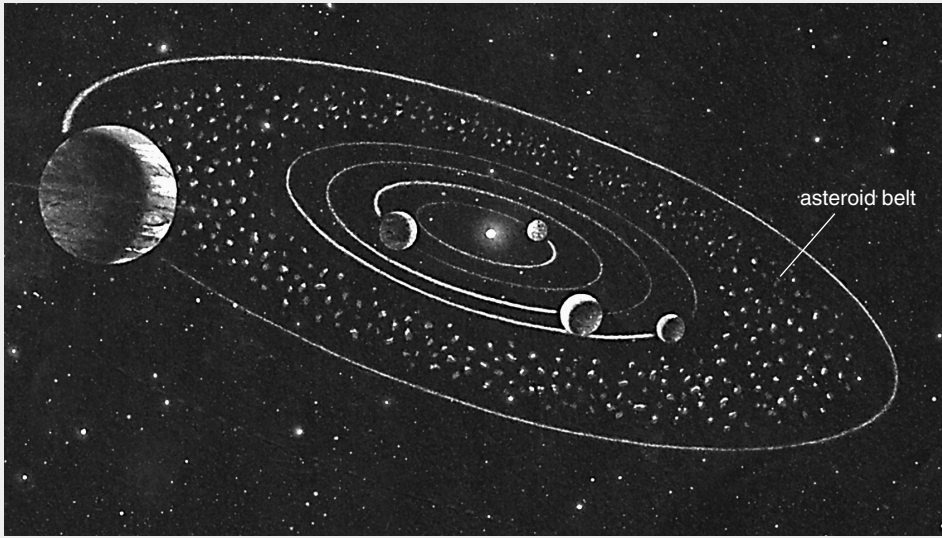

FIGURE 7.1(b) Kepler's model defines a "dissonant" interval, the orbital region between Mars and Jupiter. Decisive confirmation of Kepler's hypothesis was first made possible by Gauss's determination of the orbit of the asteroid Ceres. This region, known today as the "asteroid belt," marks the division between the "inner" and "outer" planets of the solar system, and may be the location of an exploded planet unable to survive at this harmonically unstable position. (Artist's rendering)

These constraints provide the basis for calculating, to a very high degree of precision, the position and motion of a planet or other object at any time, once the basic spatial parameters of the orbit itself (the "elements" described in Chapter 2) have been determined. The three constraints go as follows.

1. The area of the curvilinear region, swept out by the radial line connecting the centers of the given planet and the sun, as the planet passes from any position in its orbit to another, is proportional in magnitude to the time elapsed during that motion. Or, to put it another way: If P_1 , P_2 , and P_3 are three successive positions of

the planet, then the ratio of the area, swept out in going from P_1 to P_2 , to the area, swept out in passing from P_2 to P_3 , is equal to the ratio of the corresponding elapsed times. (Figure 7.2)

2. The planetary orbits have the form of perfect ellipses, with the center of the sun as a common focus.

3. The periodic times of the planets (i.e., the times required to complete the corresponding orbital cycles), are related to the major axes of the orbits in such a way, that the ratio of the squares of the periodic times of any two planets, is equal to the ratio of the cubes of the corresponding semi-major axes of the orbits. (The "semi-major axis" is half of the longest axis of the ellipse, or the distance from the center of the ellipse to either of the two extremes, located at the perihelion and aphelion points; for a circular orbit, this is the same as the radius.) Using the semi-major axis and periodic time of the Earth as units, the stated proposition amounts to saying, that the planet's periodic time T , and the semi-major axis

* Lyndon LaRouche has shed light on that relationship, through his hypothesis on the historical generation of the elements—and, ultimately, of the planets themselves—by "polarized" fusion reactions within a Keplerian-ordered, magnetohydrodynamic plasmoid, "driven" by the rotational action of the sun. In that process, Mendeleev's harmonic values for the chemical elements, and the congruent, harmonic array of orbital corridors of the planets, pre-date the generation of the elements and planets themselves!

FIGURE 7.2. Kepler's constraint for motion on an elliptical orbit. The ratios of elapsed times are proportional to the ratios of swept-out areas. In equal time intervals, therefore, the areas of the curvilinear sectors swept out by the planet, will be equal—even though the curvilinear distances traversed on the orbit are constantly changing. In the region about perihelion, nearest the sun, the planet moves fastest, covering the greatest orbital distance; whereas, at aphelion, farthest from the sun, it moves most slowly, covering the least distance. This constraint is known as Kepler's "area law," later referred to as his "Second Law."

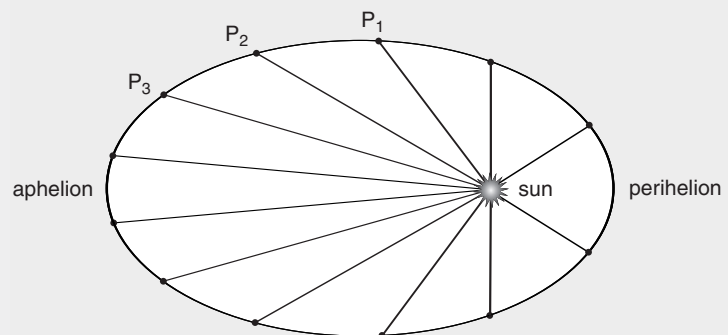

A, of the planet are connected by the relation:

$$T \times T = A \times A \times A.$$

(So, for example, the semi-major axis of Mars' orbit is very nearly 1.523674 times that of the Earth, while the Mars "year" is 1.88078 Earth years.) (Table I)

In the next chapter, we shall present Gauss's generalized form of these constraints, applied to hyperbolic and parabolic, as well as to elliptical, orbits.

Unfortunately, in the context of ensuing epistemological warfare, Kepler's constraints were ripped out of the pages of his works, severing their intimate connection with the harmonic ordering of the solar system as a whole, and finally dubbed "Kepler's Three Laws." The resulting "laws," taken in and of themselves, do not specify which orbits are possible, nor which actually occur, might have occurred, or might occur in the future; nor do they say anything about the character of the planet or other object occupying a given orbit.

This flaw did not arise from any error in Kepler's work *per se*, but was imposed from the outside. Newton greatly aggravated the problem, when he "inverted" Kepler's constraints, to obtain his "inverse square law" of gravitation, and above all when he chose—for political reasons—to make that "inversion" a vehicle for promoting a radical-empiricist, Sarpian conception of a Universe governed by pair-wise interactions in "empty" space.

However, apart from the distortions introduced by Newton *et al.*, there does exist a paradoxical relationship—of which Gauss was clearly aware—between the three constraints, stated above, and Kepler's harmonic ordering of the solar system as a whole. While rejecting the notion of Newtonian pair-wise interactions as elementary, we could hardly accept the proposition, that the orbit and motion of any planet, does not reflect the rest of the solar system in some way, and in particular the existence and motions of all the other planets, within any arbitrarily small interval of action. Yet, the three constraints make no provision for such a relationship! Although Kepler's constraints are approximately correct within a "corridor" occupied by the orbit, they do not account for the "fine structure" of the orbit, nor for certain other characteristics which we know must exist, in view of the ordering of the solar system as a whole.

A New Physical Principle

Hence the irony of Gauss's approach, which applies Kepler's three constraints as the basis for his mathematical determination of the orbit of Ceres from three observations, *as a crucial step toward uncovering a new physical*

TABLE I. *The ratio of the squares of the periodic times of any two planets, is equal to the ratio of the cubes of the corresponding mean distances to the sun, which are equal to the semi-major axes of the orbits.*

Planet	Mean distance to sun A (in A.U.*)	Time T (in Earth yrs)
Mercury	0.387	0.241
Venus	0.723	0.615
Earth	1.000	1.000
Mars	1.524	1.881
Jupiter	5.203	11.862
Saturn	9.534	29.456

* 1 Astronomical Unit (A.U.) = 1 Earth-sun distance

principle which must manifest itself in a discrepancy, however "infinitesimally small" it might be, between the real motion, and that projected by those same constraints!

Compare this with the way Wilhelm Weber later derived his electrodynamic law, and the necessary existence of a "quantum" discontinuity on the microscopic scale. Compare this, more generally, with the method of "modular arithmetic," elaborated by Gauss as the basis of his *Disquisitiones Arithmeticae*. Might we not consider any given hypothesis or set of physical principles, or the corresponding functional "hypersurface," as a "modulus," relative to which we are concerned to define and measure various species of discrepancy or "remainder" of the real process, that in turn express the effect of a new physical principle? Thus, we must discriminate, between arrays of phenomena which are "similar," or congruent, in the sense of relative agreement with an existing set of principles, and the species of anomaly we are looking for.

The concept of a series of successive "moduli" of increasing orders, in that sense, derived from a succession of discoveries of new physical principle, each of which "brings us closer to the truth by one dimension" (in Gauss's words), is essential to Leibniz's calculus, and is even implicit in Leibniz's conception of the decimal system.

With these observations in mind, we can better appreciate some of the developments following Gauss's successful forecast of the orbit of Ceres.

On March 28, 1802, a short time after the rediscovery of Ceres by several astronomers in December 1801 and January 1802, precisely confirming Gauss's forecast, Gauss's friend Wilhelm Olbers discovered *another* small planet between Mars and Jupiter—the asteroid Pallas. Gauss immediately calculated the Pallas orbit from Olber's observations, and reported back with great excitement, that the two orbits, although lying in quite differ-

ent planes, had nearly exactly the same periodic times, and appeared to cross each other in space! Gauss wrote to Olbers:

In a few years, the conclusion [of our analysis of the orbits of Pallas and Ceres—JT] might either be, that Pallas and Ceres once occupied the same point in space, and thus doubtlessly formed parts of one and the same body; or else that they orbit the sun undisturbed, and with precisely equal periods . . . [in either case,] these are phenomena, which to our knowledge are unique in their type, and of which no one would have had the slightest dream, a year and a half ago. To judge by our human interests, we should probably not wish for the first alternative. What panic-stricken anxiety, what conflicts between piety and denial, between rejection and defense of Divine Providence, would we not witness, were the possibility to be supported by fact, that a planet can be annihilated? What would all those people say, who like to base their academic doctrines on the unshakable permanence of the planetary system, when they see, that they have built on nothing but sand, and that all things are subject to the *blind and arbitrary play* of the forces of Nature! For my part, I think we should refrain from such conclusions. I find it almost wanton arrogance, to take as a measure of eternal wisdom, the perfection or imperfection which we, with our limited powers and in our caterpillar-like stage of existence, observe or imagine to observe in the material world around us.

The discovery of Ceres and Pallas, as probably the largest fragments of what had once been a larger planet, orbiting between Mars and Jupiter, helped dispose of the myth of “eternal tranquility” in the heavens. Indeed, we have good reason to believe, that cataclysmic events have occurred in the solar system in past, and might occur in the future. On an astrophysical scale, thanks to progress in the technology of astronomical observation, we are ever more frequent witnesses to a variety of large-scale events unfolding on short time scales. This includes the disappearance of entire stars in supernova explosions. The first well-documented case of this—the supernova which gave birth to the famous Crab Nebula—was recorded by Chinese astronomers in the year 1054. But, even within the boundaries of our solar system, dramatic events are by no means so exceptional as most people believe.

Apart from the hypothesized event of an explosion of a planet between Mars and Jupiter, made plausible by the discovery of the asteroid belt, collisions with comets and other interplanetary bodies are relatively frequent.

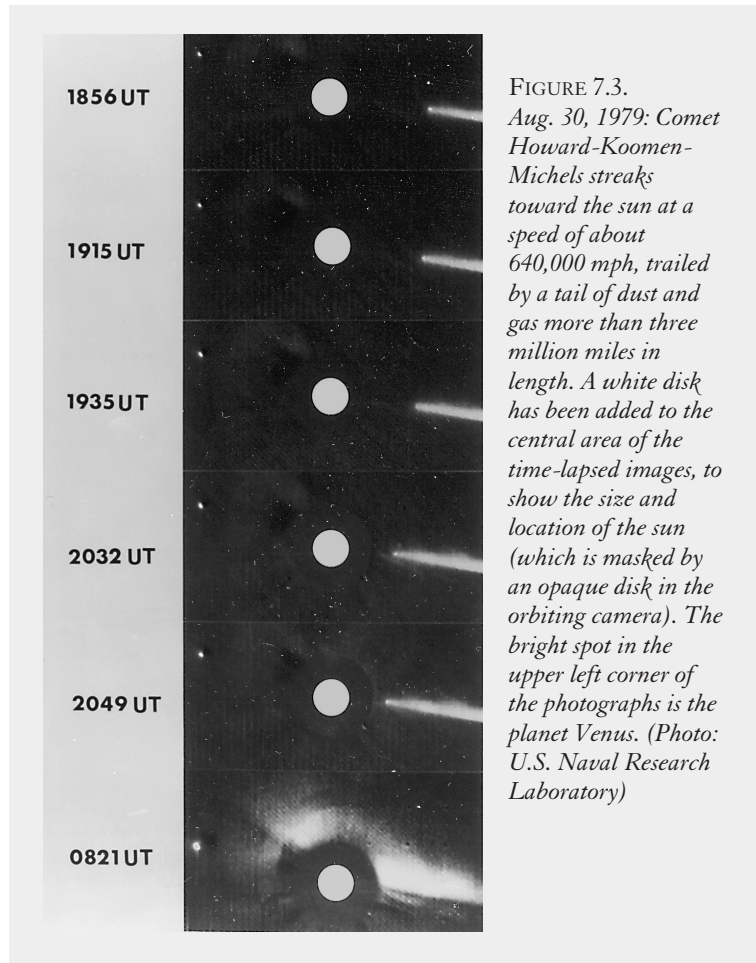

FIGURE 7.3. Aug. 30, 1979: Comet Howard-Koomen-Michels streaks toward the sun at a speed of about 640,000 mph, trailed by a tail of dust and gas more than three million miles in length. A white disk has been added to the central area of the time-lapsed images, to show the size and location of the sun (which is masked by an opaque disk in the orbiting camera). The bright spot in the upper left corner of the photographs is the planet Venus. (Photo: U.S. Naval Research Laboratory)

We witnessed one such collision with Jupiter not long ago. Another example is the collision of the comet Howard-Koomen-Michels with the surface of the sun, which occurred around midnight on Aug. 30, 1979. This spectacular event was photographed by an orbiting solar observatory of the U.S. Naval Research Laboratory. (Figure 7.3) The comet's trajectory (which ended at the point of impact) was very nearly a perfect, parabolic Keplerian orbit, whose perihelion unfortunately was located closer to the center of the sun, than the sun's own photosphere surface! A century earlier, the Great Comet of 1882 was torn apart, as it passed within 500,000 kilometers of the photosphere, emerging as a cluster of five fragments.

Beyond these sorts of events, that appear more or less accidental and without great import for the solar system as a whole, it is quite conceivable, that even the present arrangement of the planetary orbits might undergo more or less dramatic and rapid changes, as the system passes from one Keplerian ordering to another.

—JT

Parabolic and Hyperbolic Orbits

We have one last piece of business to dispose of, before we launch into Gauss's solution in Chapter 9. We have to devise a way of extending Kepler's constraints to the case of the parabolic and hyperbolic orbits, inhabited by comets and other peculiar entities in our solar system.

Comets and Non-Cyclical Orbits

During Kepler's time, the nature and motion of the comets was a subject of great debate. From attempts to measure the "daily parallax" in the apparent positions of the Great Comet of 1577, as observed at different times of the day (i.e., from different points of observation, as determined by the rotation and orbital motion of the Earth), the Danish astronomer Tycho Brahe had concluded that the distance from the Earth to the comet must be at least four times that of the distance between the Earth and Moon. Tycho's measurement was viciously attacked by Galileo, Chiaramonti, and others in Paolo Sarpi's Venetian circuits. Galileo *et al.* defended the generally accepted "exhalation theory" of Aristotle, according to which the comets were supposed to be phenomena generated inside the Earth's atmosphere. Kepler, in turn, refuted Galileo and Chiaramonti point-by-point in his late work, *Hyperaspistes*, published 1625. But Kepler never arrived at a sat-

isfactory determination of comet trajectories.

If Johann von Maedler's classic account is to be believed, the hypothesis of parabolic orbits for comets was first put forward by the Italian astronomer Giovanni Borelli in 1664, and later confirmed by the German pastor Samuel Doerfel, in 1681.

By the time of Gauss, it was definitively established that parabolic and even hyperbolic orbits were possible in our solar system, in addition to the elliptical orbits originally described by Kepler. In the introduction to his *Theory of the Motion of the Heavenly Bodies Moving about the Sun in Conic Sections*, Gauss emphasizes that the discovery of parabolic and hyperbolic orbits had added an important new dimension to astronomy. Unlike the periodic, cyclical motion of a planet in an elliptical orbit, a body moving in a parabolic or hyperbolic orbit traverses its trajectory only once.* This poses the problem of constructing the equivalent of Kepler's constraints for the case of non-elliptical orbits. (Figure 8.1)

The existence of parabolic and hyperbolic orbits, in fact, highlighted a paradox already implicit in Kepler's own derivation of his constraints, and to which Kepler himself pointed in the *New Astronomy*.†

In his initial formulation of what became known as the Second Law, Kepler spoke of the "time spent" at any given position of the orbit as being proportional to the "radial line" from the planet to the sun. He posed to future geometers the problem of how to "add up" the radial lines generated in the course of the motion, which seemed "infinite in number." Later, Kepler replaced the radial lines with the notion of sectoral areas described around the sun during the motion of "infinitely small" intervals of time. He prescribed that the ratios of those infinitesimal areas to the corresponding elapsed times, be the same for all parts of the orbit. Since that relationship is preserved during the entire process, during which such

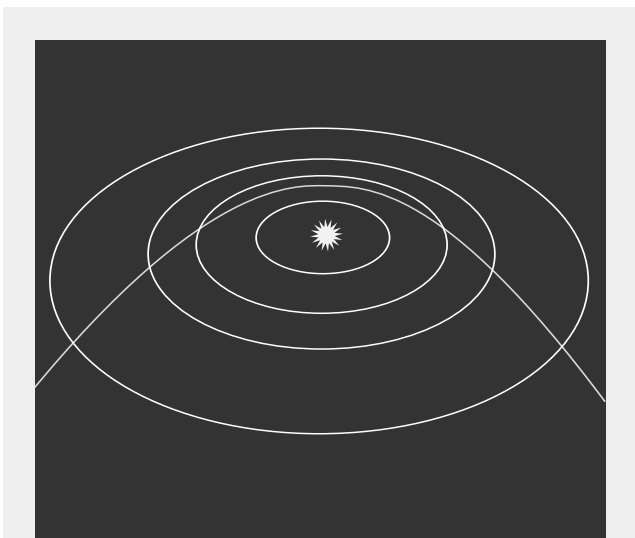
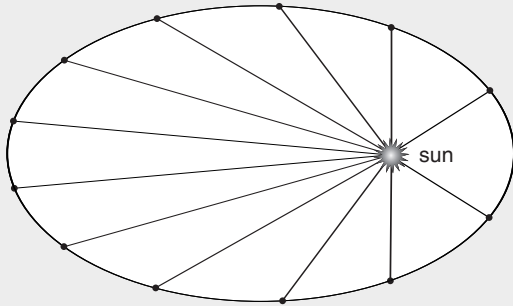

FIGURE 8.1. The parabolic path of a comet, crossing the elliptical orbits of Mercury, Venus, Earth, and Mars.

* A certain percentage of the comets have essentially elliptical orbits and relatively well-defined periods of recurrence. A famous example is Halley's Comet (which Halley apparently stole from Flamsteed), with a period of 76 years. Generally, however, the trajectories even of the recurring comets are unstable; they depend on the "conjunctural" situation in the solar system, and never exactly repeat. In the idealized case of a parabolic or hyperbolic orbit, the object never returns to the solar system. In reality, "parabolic" and "hyperbolic" comets sometimes return in new orbits.

† SEE extracts from Kepler's 1609 *New Astronomy*, pp. 24-25.

FIGURE 8.2. Kepler's "area law." The ratios of elapsed times are proportional to the ratios of swept-out areas.



"infinitesimal" areas accumulate to form a macroscopic area in the course of continued motion, it will be valid for any elapsed times whatever.

The result is Kepler's final formulation of the Second Law, which very precisely accounts for the manner in which the rate of angular displacement of a planet around the sun actually slows down or speeds up in the course of an orbit. (Figure 8.2)

However, while specifying, in effect, that the ratios of elapsed times are proportional to the ratios of swept-out areas, the Second Law says nothing about their absolute magnitudes. The latter depend on the dimensions of the orbit as a whole, a relationship manifested in the progressive, stepwise decrease in the overall periods and average velocities of the planets, as we move outward away from the sun, i.e., from Mercury, to Venus, the Earth, Mars, Jupiter, and so on. (SEE Figure 7.1b) In his *Harmony of the World* of 1619, Kepler characterized that overall relationship by what became known as the Third Law, demonstrating that the squares of the periodic times are proportional to the cubes of the semi-major axes of the orbits or, equivalently: The periodic times are proportional to the three-halves powers of the semi-major axes (SEE Table I, page 36).

Thus, the Third Law addresses the integrated result of an entire periodic motion, while the Second Law addresses the changes in rate of motion subsumed within that cycle. The relationship of the two, in terms of Kepler's original approach, is that of an integral to a differential.

What happens to the Third Law in the case of a parabolic or hyperbolic orbit? In such case, the motion is no longer periodic, and the axis of the orbit has no assignable length. The periodic time and semi-major axes have, in a sense, both become "infinite." On the other hand, the motion of comets must somehow be coherent with the Keplerian motion of the main planets, just as there exists

an overall coherence among all ellipses, parabolas, and hyperbolas, as subspecies of the family of conic sections. In fact, the motions of the comets are found to follow Kepler's Second Law to a very high degree of precision. That suggests a very simple consideration: How might we characterize the relationship between elapsed times and areas swept out, in terms of absolute values (and not only ratios), *without* reference to the length of a completed period? We can do that quite easily, thanks to Kepler's own work, by combining all three of Kepler's constraints.

Gauss's Constraints

Kepler's Second Law defines the ratio of the area swept out around the sun, to the elapsed time, as an unchanging, characteristic value for any given orbit. For an elliptical orbit, Kepler's Third Law allows us to determine the value of that ratio, by considering the special case of a single, completed orbital period. The area swept out during a complete period, is the entire area of the ellipse, which (as was already known to Greek geometers) is equal to $\pi \times A \times B$, where A and B are the semi-major and semi-minor axes, respectively. The elapsed time is the duration T of a whole period, known from Kepler's Third Law to be equal to $A^{3/2}$, when the semi-major axis and periodic time of the Earth's orbit are taken as units. The quotient of the two is $\pi \times A \times (B/A^{3/2})$, or in other words $\pi \times (B/\sqrt{A})$. Now, the quotient B/\sqrt{A} has a special significance in the geometry of elliptical orbits [SEE Appendix (I)]: Its square, B^2/A , is equal to the "half-parameter" of the ellipse, which is half the width of the ellipse as measured across the focus in the direction perpendicular to the major axis. (Figure 8.3a) The importance of the half-parameter, which is equivalent to the radius in the case of a circle, lies in the fact that it has a definite meaning not only for circular and elliptical orbits, but also for parabolic and hyperbolic ones. (Figures 8.3b and c) The "orbital parameter" and "half-parameter" played an important role in Gauss's astronomical theories.

We can summarize the result just obtained as follows: For elliptical orbits, at least, the value of Kepler's ratio of area swept out to elapsed time—a ratio which is constant for any given orbit—comes out to be

$$\pi \times \sqrt{H},$$

where H is the half-parameter of the orbit. Unlike a periodic time and finite semi-major axis, which exist for elliptical but not parabolic or hyperbolic orbits, the "parameter" does exist for all three. Does the corresponding relationship actually hold true, for the actually observed trajectories of comets? It does, as was verified, to a high degree of accuracy, by Olbers and earlier

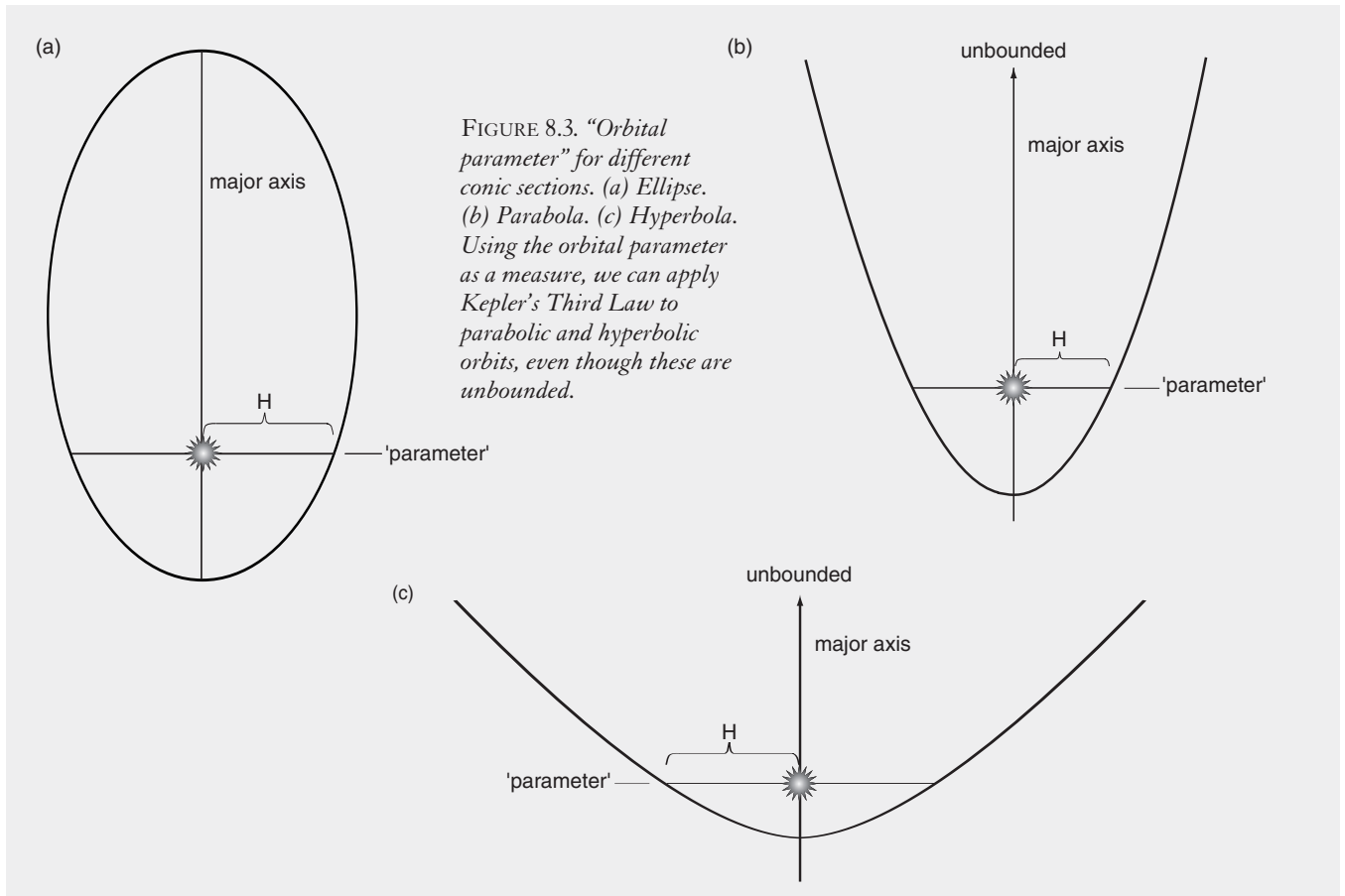

astronomers prior to Gauss's work.

The purpose of this exercise was to provide a replacement for Kepler's Third Law, which applies to parabolic and hyperbolic orbits, as well as to elliptical ones. We have succeeded. The constant of proportionality, connecting the ratio of area and time on the one side, and the square root of the "parameter" on the other, came to be known as "Gauss's constant." Taking the orbit of Earth as a unit, the constant is equal to π .

With one slight, additional modification, whose details need not concern us here,* the following is the generalized form of Kepler's constraints, which Gauss sets forth at the outset of his *Theory of the Motion of the Heavenly Bodies Moving about the Sun in Conic Sections*.

Gauss emphasizes that they constitute "the basis for all the investigations in this work":

(i) The motion of any given celestial body always occurs in a constant plane, upon which lies, at the same time, the center of the sun.

(ii) The curve described by the moving body is a conic section whose focus lies at the center of the sun.

(iii) The motion in that curve occurs in such a way, that the sectoral areas, described around the sun during various time intervals, are proportional to those time intervals. Thus, if one expresses the times and areas by numbers, the area of any sector, when divided by the time during which that sector was generated, yields an unchanging quotient.

(iv) For the various bodies orbiting around the sun, the corresponding quotients are proportional to the square roots of the half-parameters of the orbits.

—JT

* In his formulation in the *Theory of the Motion*, Gauss includes a factor correcting for a slight effect connected with the "mass ratio" of the planet to the sun. That effect, manifested in a slight increase in Kepler's ratio of area to elapsed time, becomes distinctly noticeable only for the larger planets, especially Jupiter, Saturn, and Uranus. The "mass," entering here, does

not imply Newton's idea of some self-evident quality inhering in an isolated body. Rather, "mass" should be considered as a complex physical effect, measurable in terms of slight discrepancies in the orbits, i.e., as an additional dimension of curvature involving the relationship of the orbit, as singularity, to the entire solar system.

Gauss's Order of Battle

Now, let us join Gauss, as he thinks over the problem of how to calculate the orbit of Ceres. Gauss had at his disposal about twenty observations, made by Piazzi during the period from Jan. 1 to Feb. 11, 1801. The data from each observation consisted of the specification of a moment in time, precise to a fraction of a second, together with two angles defining the precise direction in which the object was seen at that moment, relative to an astronomical system of reference defined by the celestial sphere, or “sphere of the fixed stars.” Piazzi gave those angles in degrees, minutes, seconds, and tenths of seconds of arc.

In principle, each observation defined a line through space, starting from the location of Piazzi's telescope in space at the moment of the observation—the latter determinable in terms of the Earth's known rotation and motion around the sun—and directed along the direction defined by Piazzi's pair of angles. Naturally, Gauss had to make corrections for various effects such as the precession of the Earth's axis, aberration and refraction in the Earth's atmosphere, and take account of possible margins of error in Piazzi's observations.

Although the technical execution of Gauss's solution is rather involved, and required a hundred or more hours of calculation, even for a master of analysis and numerical computation such as Gauss, the basic method and principles of the solution are in principle quite elementary. Gauss's tactic was, first, to determine a relatively rough approximation to the unknown orbit, and then to progressively refine it, up to a high degree of precision.

Gauss's procedure was based on using only three observations, selected from Piazzi's data. Gauss's original choice consisted of the observations from Jan. 2, Jan. 22, and Feb. 11. (Figure 1.1) Later, Gauss made a second, definitive round of calculations, based on using the observations of Jan. 1 and Jan. 21, instead of Jan. 2 and Jan. 22.

Overall, Piazzi's observations showed an apparent retrograde motion from the time of the first observation on Jan. 1, to Jan. 11, around which time Ceres reversed to a forward motion. Most remarkable, was the size of the angle separating Ceres' apparent direction from the plane of the ecliptic—an angle which grew from about 15° on Jan. 1, to over 18° at the time of Piazzi's last observation. That wide angle of separation from the ecliptic, together with the circumstance, that all the major planets were

known to move in planes much closer to the ecliptic, prompted Piazzi's early suspicion that the object might turn out to be a comet.

Gauss's first goal, and the most challenging one, was *to determine the distance of Ceres from the Earth*, for at least one of the three observations. In fact, Gauss chose the *second* of the unknown distances—the one corresponding to the intermediate of the three selected observations—as the prime target of his efforts. Finding that distance essentially “breaks the back” of the problem. Having accomplished that, Gauss would be in a position to successively “mop up” the rest.

In fact, Gauss used his calculation of that value to determine the distances for the first and third observations; from that, in turn, he determined the corresponding spatial positions of Ceres, and from the two spatial conditions and the corresponding time, he calculated a first approximation of the orbital elements. Using the coherence provided by that approximate orbital calculation, he could revise the initial calculation of the distances, and obtain a second, more precise orbit, and so on, until all values in the calculation became coherent with each other and the three selected observations.

The discussion in Chapter 2 should have afforded the reader some appreciation of the enormous ambiguity contained in Piazzi's observations, when taken at face value. Piazzi saw only a faint point of light, only a “line of sight” *direction*, and nothing in any of the observations *per se*, permitted any conclusion whatsoever about how far away the object might be. It is only by analyzing the *intervals* defined by all three observations taken together, on the basis of the underlying, Keplerian curvature of the solar system, that Gauss was able to reconstruct the reality behind what Piazzi had seen.

Polyphonic Cross-Voices

Gauss's opening attack is a masterful application of the kinds of synthetic-geometrical methods, pioneered by Gérard Desargues *et al.*, which had formed the basis of the revolutionary accomplishments of the Ecole Polytechnique under Gaspard Monge.

Firstly, of course, we must have confidence in the powers of Reason, that the Universe is composed in such a way, that the problem can be solved. Secondly, we must

consider everything that might be relevant to the problem. We are not permitted to arbitrarily “simplify” the problem. We cannot say, “I refuse to consider this, I refuse to consider that.”

To begin with, it is necessary to muster not only the relevant data, but above all the *complex of interrelationships*—potential polyphonic cross-voices!—underlying the three observations in relation to each other and (chiefly) the sun, the positions and known orbital motion of the Earth, the unknown motion of Ceres, and the “background” of the rest of the solar system and the stars.

Accordingly, denote the times of the three observations by t_1, t_2, t_3 , the corresponding (unknown!) true spatial positions of Ceres by P_1, P_2, P_3 , and the corresponding positions of the Earth (or more precisely, of Piazzi’s observatory) at each of the three moments of observation, by E_1, E_2, E_3 . Denote the position of the center of the sun by O . (**Figure 9.1**) We must consider the following relationships in particular:

(i) The three “lines of sight” corresponding to Piazzi’s observations. These are the lines passing from E_1 through P_1 , from E_2 through P_2 , and from E_3 through P_3 . As already noted, the observations tell us only the *directions* of those lines and, from knowledge of the Earth’s motion, their points of origin, E_1, E_2 and E_3 ; but *not* the *distances* E_1P_1, E_2P_2 and E_3P_3 .

(ii) The *elapsed times* between the observations, taken pairwise, i.e., $t_2 - t_1, t_3 - t_2$, and $t_3 - t_1$, as well as the ratios or intervals of those elapsed times, for example $t_3 - t_2 : t_2 - t_1$, $t_2 - t_1 : t_3 - t_1$, $t_3 - t_2 : t_3 - t_1$, and the various permutations and

FIGURE 9.1. Positions of the sun (O), Earth (E), and Ceres (P), at the three times of observation. P_1, P_2, P_3 must lie on lines of sight L_1, L_2, L_3 , but their distances from Earth are not known.

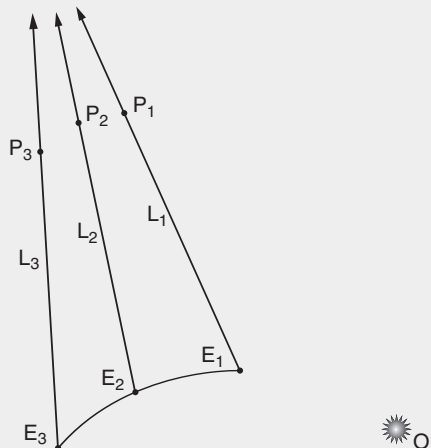
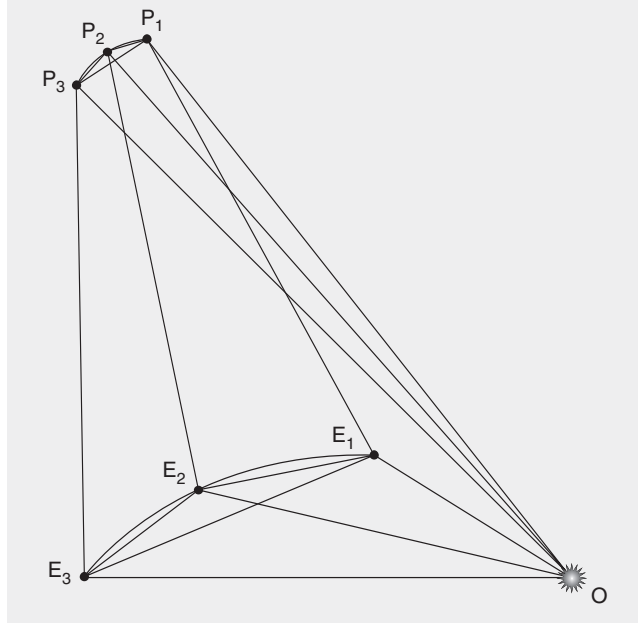

FIGURE 9.2. Triangular relationships among Earth, Ceres, and the sun.



inversions of these.

(iii) The *orbital sectors* for the Earth and Ceres, corresponding to the elapsed times just enumerated, in relation to one another and the elapsed times.

(iv) The *triangles* formed by the positions of the Earth, Ceres and the sun, in particular the triangles $OE_1E_2, OE_2E_3, OE_1E_3$, and triangles $OP_1P_2, OP_2P_3, OP_1P_3$, representing relationships among the three positions of the Earth and of Ceres, respectively; plus the three triangles formed by the positions of the sun, the Earth and Ceres at each of the three times, taken together: $OE_1P_1, OE_2P_2, OE_3P_3$. Also, each of the line segments forming the sides of those triangles. (**Figure 9.2**)

Each line segment must be considered, not as a noun but as a verb, a geometrical interval. For example, the segment E_1P_1 implies a potential action of displacement from E_1 to P_1 . Displacement E_1P_1 is therefore not the same as P_1E_1 .

(v) The relationships (including relationships of area) between the triangles $OE_1E_2, OE_2E_3, OE_1E_3$, as well as $OP_1P_2, OP_2P_3, OP_1P_3$ and the corresponding orbital sectors, as well as the elapsed times, in view of the Kepler/Gauss constraints.

Gauss’s immediate goal, is to determine the second of those distances, the distance from E_2 to P_2 . Call that critical unknown, “ D .” (**Figure 9.3**)

Although we shall not require it explicitly here, for his detailed calculations, Gauss, in a typical fashion, intro-

FIGURE 9.3. Gauss's immediate goal: determine distance D from E_2 to P_2 .

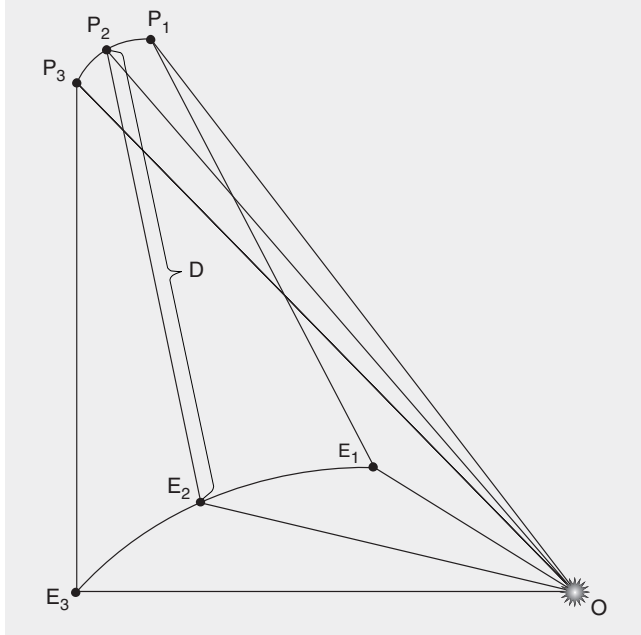

duces a spherical projection into the construction, transferring the directions of all the various lines in the problem for reference to a single center. (Figure 9.4) Thereby, Gauss generates a new set of relationships, as indicated in Figure 9.4.

Faced with this bristling array of relationships, some readers might already be inclined to call off the war, before it has even started. Don't be a coward! Don't be squeamish! Nothing much has happened yet. However bewildering this complex of spatial relationships might appear at first sight, remember: everything is bounded by the curvature of what Jacob Steiner called "the organism of space." All relationships are generated by one and the same Gaussian-Keplerian principle of change, as embodied in the combination of motions of the Earth and Ceres, in particular. The apparent complexity just conceals the fact that we are seeing one and the same "One," reflected and repeated in many predicates.

As for the construction, it is all in our heads. Seen from the standpoint of Desargues, the straight lines are nothing but artifacts subsumed under the "polyphonic" relationships of the angles formed by the various directions, seen as "monads," located at the sun, Earth, and Ceres.

Somewhere within these relationships, the desired distance "D" is lurking. How shall we smoke it out? Might the answer not lie in looking for the footprints of a differential of curvature between the Earth's motion and the (unknown) motion of Ceres?

We shall discover Gauss's wonderfully simple solution in the following chapter.

—JT

FIGURE 9.4. Gauss's spherical mapping. The directions of the lines L_1, L_2, L_3 are transferred to an imaginary sphere S , by drawing unit segments l_1, l_2, l_3 , parallel to L_1, L_2, L_3 , respectively, from the center c . In addition (although not shown here, for the sake of simplicity), Gauss transferred all the other directions in the problem—i.e., the directions of the lines OE_1, OE_2, OE_3 , and OP_1, OP_2, OP_3 —to the "reference sphere," thus obtaining a summary of all the angular relationships.

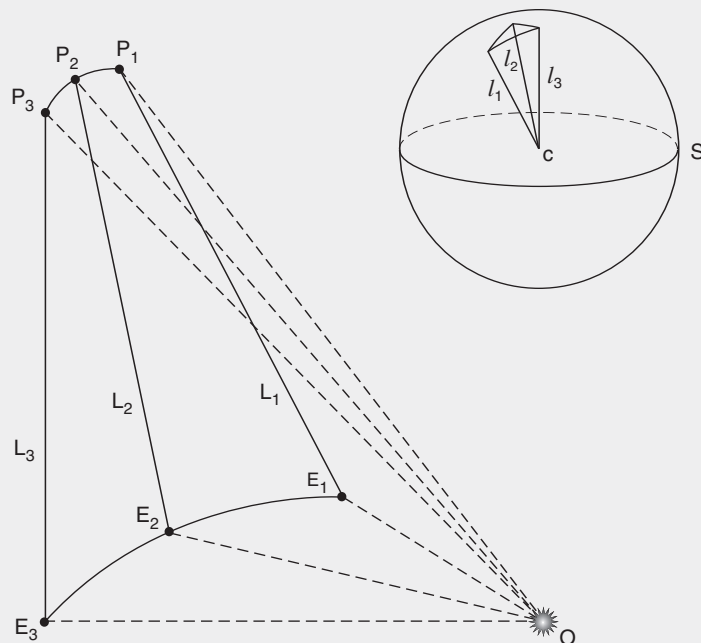

Closing In on Our Target

Gauss is a mathematician of fanatical determination, he does not yield even a hand's width of terrain. He has fought well and bravely, and taken the battlefield completely.

—Comment by Georg Friedrich von Tempelhoff, 1799.

Prussian General and Chief of Artillery, Tempelhoff was also known for his work in mathematics and military history. The youthful

Gauss, who regarded him as one of the best German mathematicians, had sent him a pre-publication copy of his *Disquisitiones Arithmeticae*.

Although Gauss knew analytical calculation perhaps better than any other living person, he was sharply opposed to any mechanical use of it, and sought to reduce its use to a minimum, as far as circumstances allowed. He often told us, that he never took a pencil into his hand to calculate, before the problem had been completely solved by him in his head; the calculation appeared to him merely as a means by which to carry out his work to its conclusion. In discussions about these things, he once remarked, that many of the most famous mathematicians, including very often Euler, and even sometimes Lagrange, trusted too much to calculation alone, and could not at all times account for what they were doing in their investigations. Whereas he, Gauss, could affirm, that at every step he always had the goal and purpose of his operations precisely in mind, and never strayed from the path.

—Walther Sartorius von Waltershausen, godson of Goethe and a student and close friend of Gauss, in a biographical sketch written soon after Gauss's death in December 1855.

In the last chapter, we mustered the key elements which must be taken into account to determine the Earth-Ceres distances and, eventually, the orbit of Ceres, from a selection of three observations, each giving a time and the angular coordinates of the apparent position of Ceres in the heavens at the corresponding instants.

Our suggested approach is to “read” the space-time intervals among the three chosen observations, as implicitly expressing a relationship between the curvatures of the orbits of Earth and Ceres. Then, compare the adduced differential, with the “projected” appearance, to derive the distances and the positions of the object.

To carry out this idea, Gauss first focusses on the man-

FIGURE 10.1. Sectoral areas S_{12} and S_{23} , swept out as Ceres moves, respectively, from P_1 to P_2 , and from P_2 to P_3 .

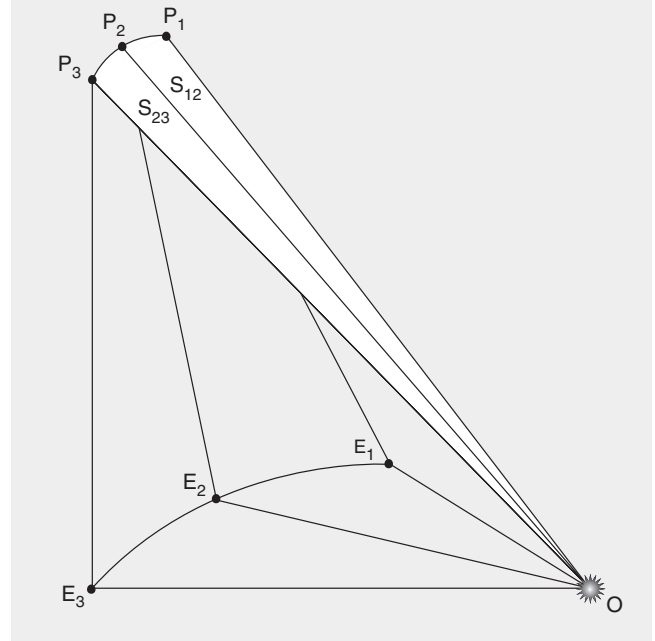

ner in which the second (“middle”) position of each planet is related to its first and third (i.e., “outer”) positions. In other words: How is P_2 related to P_1 and P_3 ? And, what is the distinction of the relation of P_2 to P_1 and P_3 , in comparison with that of E_2 to E_1 and E_3 ? (Figure 10.1)

Thanks to our knowledge of the overall curvature of the solar system, embodied *in part* in the Gauss-Kepler constraints, we can say something about those questions, even before knowing the details of Ceres’ orbit.

To wit: Regard P_2 and E_2 as singularities resulting from *division of the total action of the solar system*, which carries Ceres from P_1 to P_3 , and simultaneously carries the Earth from E_1 to E_3 , during the time interval from t_1 to t_3 . In both cases, the Gauss-Kepler constraints tell us, that the *sectoral areas* swept out by the two motions, are proportional to the elapsed times. The latter, in turn, are known to us, from Piazzi’s observations.

Explore this matter further, as follows. Concentrating first on Ceres, write, as a shorthand:

$$S_{12} = \text{area of orbital sector swept out by Ceres from } P_1 \text{ to } P_2,$$

$$S_{23} = \text{area of orbital sector from } P_2 \text{ to } P_3,$$

S_{13} = area of orbital sector from P_1 to P_3 .

According to the Gauss-Kepler constraints, the ratios

$$S_{12}:t_2-t_1, S_{23}:t_3-t_2, \text{ and } S_{13}:t_3-t_1,$$

which are equivalent to the fractional expressions more easily used in computation

$$\frac{S_{12}}{t_2-t_1}, \frac{S_{23}}{t_3-t_2}, \text{ and } \frac{S_{13}}{t_3-t_1},$$

all have the same identical value, namely, the product of Gauss's constant (in our context equal to π) and the square root of Ceres' orbital parameter. (SEE Chapter 8) The analogous relationships obtain for the Earth. Now, we don't know the value of Ceres' orbital parameter, of course; nevertheless, the above-mentioned proportionalities are enough to determine key "cross"-ratios of the areas and times among themselves, without reference to the orbital parameter. For example, the just-mentioned circumstance that

$$S_{12} : \text{elapsed time } t_2-t_1 :: S_{23} : \text{elapsed time } t_3-t_2$$

(the " :: " symbol means an equivalence between two ratios), has as a consequence, that the ratio of those areas must be equal to the ratio of the elapsed times, or in other words:

$$\frac{S_{12}}{S_{23}} = \frac{t_2-t_1}{t_3-t_2},$$

and similarly for the various permutations of orbital positions 1, 2, and 3.

Now, we can compute the elapsed times, and their ratios, from the data supplied by Piazzi, for the observations chosen by Gauss. The specific values are not essential to the general method, of course, but for concreteness, let's introduce them now. In terms of "mean solar time," the times given by Piazzi for the three chosen observations, were as follows:

t_1 = 8 hours 39 minutes and 4.6 seconds p.m. on Jan. 2, 1801.

t_2 = 7 hours 20 minutes and 21.7 seconds p.m. on Jan. 22, 1801.

t_3 = 6 hours 11 minutes and 58.2 seconds p.m. on Feb. 11, 1801.

The circumstance, that t_2 is nearly half-way between t_1 and t_3 , yields a certain advantage in Gauss's calculations, and is one of the reasons for his choice of observations. Calculated from the above, the elapsed times are:

$$t_2-t_1 = 454.68808 \text{ hours,}$$

$$t_3-t_2 = 478.86014 \text{ hours, and}$$

$$t_3-t_1 \text{ (the sum of the first two)} = 933.54842 \text{ hours.}$$

Calculating the various ratios, and taking into account what we just observed concerning the implications of the Gauss-Kepler constraints, we get the following conclusion:

$$\frac{S_{12}}{S_{23}} = \frac{t_2-t_1}{t_3-t_2} = 0.94952,$$

$$\frac{S_{12}}{S_{13}} = \frac{t_2-t_1}{t_3-t_1} = 0.48705,$$

$$\frac{S_{23}}{S_{13}} = \frac{t_3-t_2}{t_3-t_1} = 0.51295.$$

Everything we have said so far, including the numerical values just derived, applies just as well to the Earth, as to Ceres. We merely have to substitute the areas swept out by the Earth in the corresponding times. Of course, in the case of the Earth, we know its positions and orbital motion quite precisely; here, the ratios of the sectoral areas tell us nothing essentially new. For Ceres, whose orbit is *unknown* to us, our application of the "area law" has placed us in a paradoxical situation: Without, for the moment, having any way to calculate the orbit and the areas of the orbital sectors themselves, we now have precise values for the *ratios* of those areas!

How could we use those ratios, to derive the orbit of Ceres? Not in any linear way, obviously, because the same values apply to the Earth and *any* planet moving according to the Gauss-Kepler constraints. The key, here, is not to think in terms of "getting to the answer" by some "straight-line" procedure. Rather, we have to think of progressing in *dimensionalities*, just as in a battle we strive to increase the freedom of action of our own forces, while progressively reducing that of the enemy forces. So, at each stage of our determination of the Ceres orbit, we try to increase what we know by one or more dimensions, while reducing the indeterminacy of what we must know, but don't yet know, to a corresponding extent. We don't have to worry about how the orbital values will finally be calculated, in the end. It is enough to know, that by proceeding in the indicated way, the values will eventually be "pinned down" as a matter of course.

So, our acquiring the values for the *ratios* of the sectoral areas generated by Ceres' motion, does not in itself lead to the desired orbital determination; but, in the context of the whole complex of relationships, we have closed in on our target by at least one "dimensionality."

Accordingly, return once more to the relationship of the intermediate position of Ceres (P_2), to the outside positions (P_1 and P_3). Introduce a new tactic, as follows.

FIGURE 10.2. The famous “parallelogram law” for combination of displacements OA and OB , assumes that the result of the combination does not depend on the order in which the displacements are carried out—i.e., that C and D coincide. Gauss considered that this might only be approximately true, and that the parallelogram law might break down when the displacements are very large.

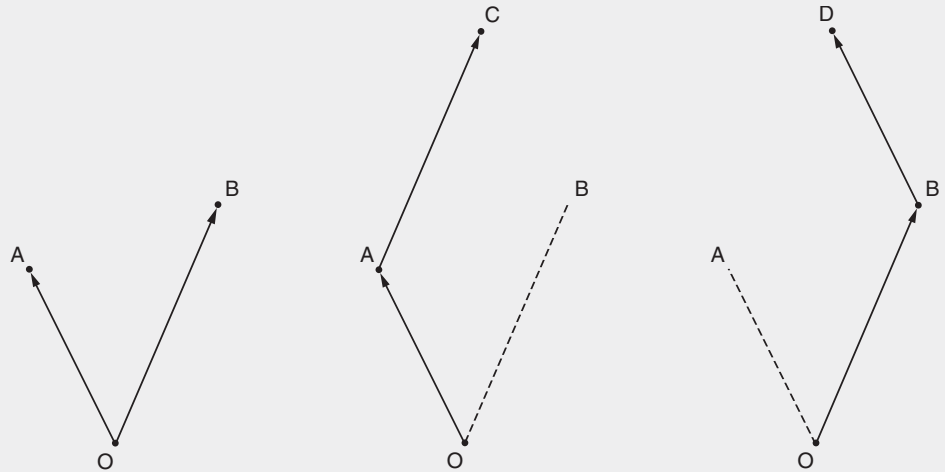

The Harmonic Ordering of Action in Space

Among most elementary characteristics of the “organism of space,” is the manner in which the result of a series of displacements, is related to the individual displacements making up that series. This concerns us very much in the case in point. For example, the *apparent* position of Ceres, as seen from the Earth at any given moment, corresponds to the direction, in space, of the line segment from the Earth to Ceres. The latter, seen as a geometrical interval or displacement, can be represented as a differential between two other spatial intervals or displacements, namely the interval from the sun to the Earth, “subtracted,” in a sense, from the interval from the sun to Ceres. Or, to put it another way: the displacement

from the sun to Ceres, can be broken down as the resultant or sum of the displacement from the sun to the Earth, following by the displacement from the Earth to Ceres. Similarly, we have to take account of successive displacements corresponding to the motions P_1 to P_2 , P_2 to P_3 , E_1 to E_2 , E_2 to E_3 , etc.

Now, this *apparently* self-evident mode of combining displacements, involves an *implicit assumption*, which Gauss was well aware of. If I have two displacements from a *common locus*, say from the O (i.e., the center of the sun) to a location A , and from the O to location B , then I might envisage the combination or addition of the displacements in either of the following two ways (**Figure 10.2**): I might apply the first displacement, to go from O to A , and then go from A to a third location, C , by displacing *parallel* to the second displacement from

FIGURE 10.3. Derivation of the location of P_2 by parallel displacements along directions OP_1 and OP_3 .

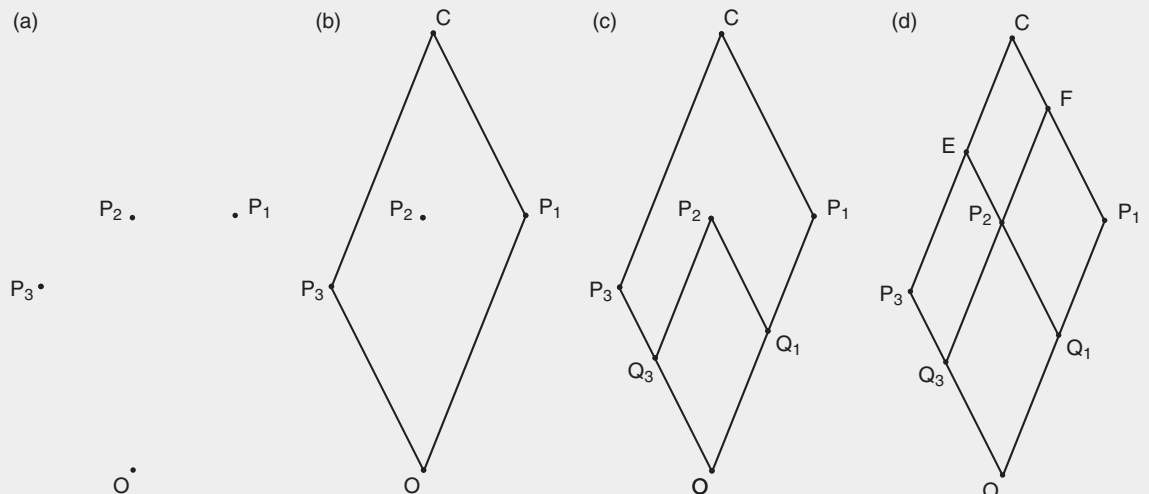

the O to B , and by the same distance. The displacement from A to C is parallel and congruent to that from O to B , and can be considered as equivalent to the latter in that sense. Or, I might operate the displacements in the *opposite order*; moving first from O to B , and *then* moving parallel and congruent with OA , from B to a point D . The obvious assumption here is, that the two procedures produce the same end result, or in other words, that C and D will be the same location. In that case, the displacements OA, AC, OB, BC will form a *parallelogram* whose opposing pairs of sides are congruent and parallel line segments.

Could it happen, that C and D might actually turn out to be different, in reality? Gauss himself sought to define large-scale experiments using beams of light, which might produce an anomaly of a similar sort. Gauss was convinced, that Euclidean geometry is nothing but a useful approximation, and that the actual characteristics of visual space, are derived from a higher, “anti-Euclidean” curvature of space-time. Such an “anti-Euclidean” geometry, is already implied by the Keplerian harmonic ordering of the solar system, and would be demonstrated, again, by Wilhelm Weber’s work on electromagnetic singularities in the microscopic domain, as well as the work of Fresnel on the nonlinear behavior of light “in the small.” Hence, once more, the irony of Gauss’s applying elementary constructions of Euclidean geometry, to the orbital determination of Ceres. Gauss’s use of such constructions, is informed by the primacy of the “anti-Euclidean” geometry, in which his mind is already operating.

Turning to the relationship of P_2 to P_1 and P_3 , the question naturally arises: Is it possible to describe the

location P_2 , as the combined result of a pair of displacements, along the directions of OP_1 and OP_3 , respectively? **(Figure 10.3)** The possibility of such a representation, is already implicit in the fact, emphasized by Gauss in his reformulation of Kepler’s constraints, that the orbit of any planet lies in a *plane* passing through the center of the sun. A plane, on the other hand, is a simplified representation of a “doubly extended manifold,” where all characteristic modes of displacement are reducible to two principles or “dimensionalities.” On the elementary geometrical level, this means, that out of any *three* displacements, such as OP_1, OP_2 , and OP_3 , one must be reducible to a combination of the other two, or at least of displacements along the directions defined by the other two. In fact, it is easy to construct such a decomposition, as follows.

Start with only the two displacements OP_1 and OP_3 . Combine the two displacements, in the manner indicated above, to generate a point C , as the fourth vertex of a parallelogram consisting of OP_1, OP_3, P_1C , and P_3C . **(Figure 10.3b)** Now, apart from extreme cases (which we need not consider for the moment), the position P_2 will lie *inside* the parallelogram. We need only “project” P_2 onto each of the “axes” OP_1, OP_3 by lines parallel with the other axis. **(Figure 10.3c)** In other words, draw a parallel to OP_1 through P_2 , intersecting the segment OP_3 at a point Q_3 , and intersecting the parallel segment P_1C at a point F . Draw a parallel to OP_3 through P_2 , intersecting the segment OP_1 at a point Q_1 and the parallel segment P_3C at a point E . The result of this construction, is to create several sub-parallelograms, including one with sides $OQ_1, Q_1P_2, OQ_3, Q_3P_2$, and having P_2 as a vertex. **(Figure 10.3d)**

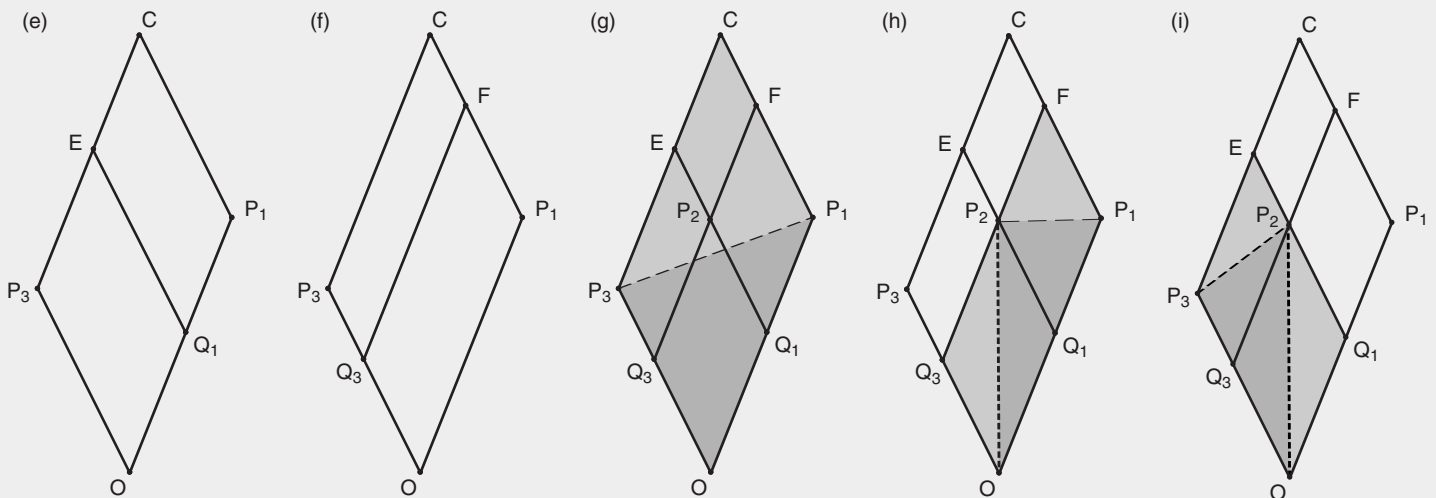
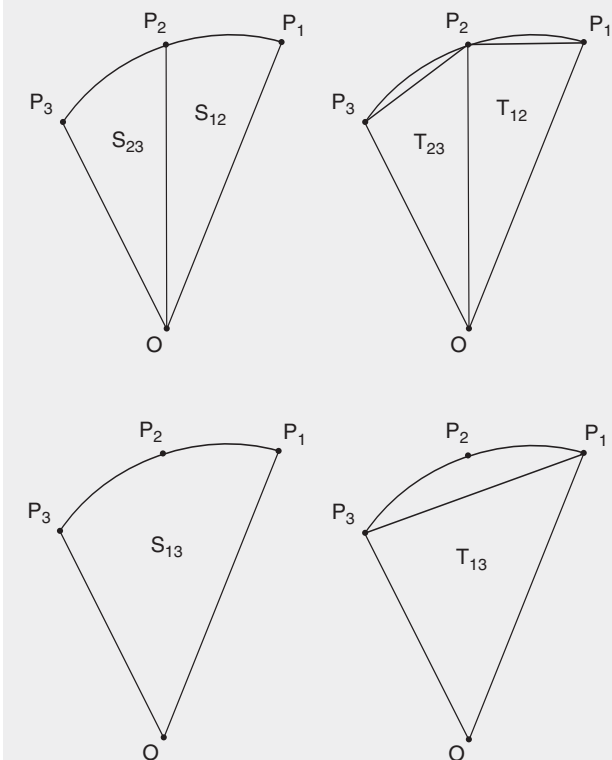

FIGURE 10.4. Orbital sectors S_{12}, S_{23}, S_{13} , and their corresponding triangular areas T_{12}, T_{23}, T_{13} .



Examining this result, we see that the displacement OP_2 , which corresponds to the diagonal of the above mentioned sub-parallelogram, is equivalent, *by construction*, to the combination or sum of the displacements OQ_1 and OQ_3 , the latter lying along the axes defined by P_1 and P_3 . We have thus expressed the position of P_2 in terms of P_1, P_3 , and the two other division points Q_1 and Q_3 .

This suggests a new question: Given, that all these constructions are hypothetical in character, since the positions of P_1, P_2 , and P_3 are yet unknown to us, do Piazzi's observations together with the Gauss-Kepler constraints, allow us to draw any conclusions of interest, concerning the location of the points Q_1 and Q_3 , or at least the shape and *proportions* of the sub-parallelogram $OQ_1P_2Q_3$, in relation to the parallelogram OP_1CP_3 ?

Aha! Why not have a look at the relationships of *areas* involved here, which must be related in some way to the areas swept out during the orbital motions. First, note that the line Q_1E , which was constructed as the parallel to OP_3 through P_2 , divides the area of the whole parallelogram OP_1CP_3 according to a specific proportion, namely

that defined by the ratio of the segment OQ_1 , to the larger segment OP_1 . (**Figure 10.3e**) Similarly, the line Q_3F divides the area of the whole parallelogram according to the proportion of OQ_3 to OP_3 . (**Figure 10.3f**) Or, conversely: the ratios $OQ_1:OP_1$ and $OQ_3:OP_3$ are the same, respectively, as the *ratios of the areas* of the sub-parallelograms OQ_1EP_3 and OQ_3FP_1 , to the whole parallelogram OP_1CP_3 .

What are those areas? Examining the triangles generated by our division of the parallelogram, and by the segments P_1P_2, P_2P_3 , and P_1P_3 , observe the following: The triangle OP_1P_3 makes up exactly *half* the area of the whole parallelogram OP_1CP_3 . (**Figure 10.3g**) The triangle OP_1P_2 makes up half the area of the sub-parallelogram OQ_3FP_1 (**Figure 10.3h**), and the triangle OP_2P_3 makes up exactly half the area of the parallelogram OQ_1EP_3 . (**Figure 10.3i**) Consequently, the ratios of the parallelogram areas, which in turn are the ratios by which Q_3 and Q_1 divide the segments OP_3 and OP_1 , respectively, are nothing other than the ratios of the triangular areas OP_1P_2 and OP_2P_3 , respectively, to the triangular area OP_1P_3 . As a shorthand, denote those areas by T_{12} , T_{23} , and T_{13} , respectively. (**Figure 10.4**)

This brings us to a critical juncture in Gauss's whole solution: How are the areas of the triangles, just mentioned, related to the corresponding sectors, swept out by the motion of Ceres, and whose ratios are known to us?

Comparing T_{12} with S_{12} , for example, we see that the difference lies only in the relatively small area, enclosed between the orbital arc from P_1 to P_2 , and the line segment connecting P_1 and P_2 . The magnitude of that area, is an effect of the curvature of the orbital arc. Now, if we knew what that was, we could calculate the ratios of the triangular areas from the known ratios of the sectors; and from that, we would be in possession of the ratios defining the division of OP_1 and OP_3 by the points Q_1 and Q_3 . Those ratios, in turn, express the spatial relationship between the intermediate position P_2 and the outer positions P_1 and P_3 . As we shall see in Chapter 11, that would bring us very close to being able to calculate the distance of Ceres from the Earth, by comparing such an adduced spatial relationship, to the observed positions as seen from the Earth.

Fine and good. But, what do we know about the curvature of the orbital arc from P_1 to P_3 ? Was it not exactly the problem we wanted to solve, to determine what Ceres' orbit is? Or, do we know something more about the curvature, even without knowing the details of the orbit?

—JT

Approaching the *Punctum Saliens*

We are nearing the *punctum saliens* of Gauss’s solution. The constructions in this and the following chapters are completely elementary, but highly polyphonic in character.

Let us briefly review where we stand, and add some new ideas in the process.

Recall the nature of the problem: We have three observations by Piazzi, reporting the apparent position of Ceres in the sky, as seen from the Earth, at three specified moments of time, approximately twenty days apart. The first task set by Gauss, is to determine the distance of Ceres from the Earth for at least one of those observations.

Two “awesome” difficulties seemed to stand in our way:

First, the observations of the motion of Ceres, were made from a point which is not fixed in space, but is also moving. The position and apparent motion of Ceres, as seen from the Earth, is the result of not just one, but several simultaneous processes, including Ceres’ actual orbital motion, but also the orbital motion and daily rotation of the Earth. In addition, Gauss had to “correct” the observations, by taking account of the precession of the equinoxes (the slow shift of the Earth’s rotational axis), optical aberration and refraction, etc.

Secondly, there is nothing in the observations of Ceres *per se*, which gives us any direct hint, about how distant

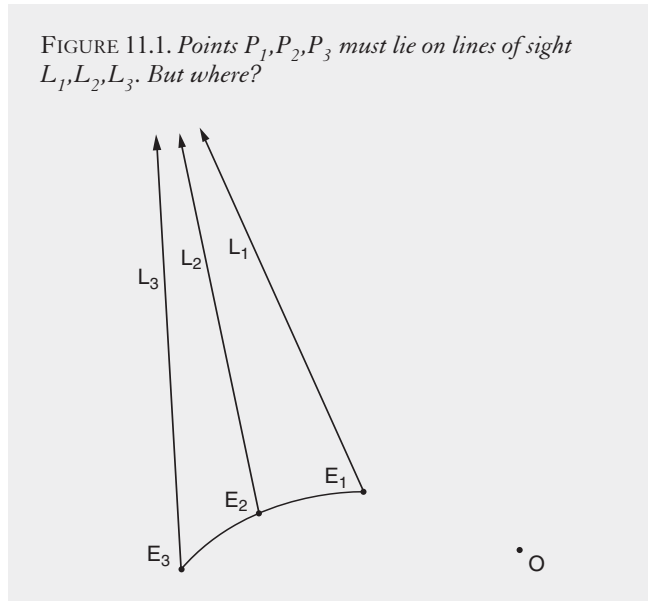

FIGURE 11.1. Points P_1, P_2, P_3 must lie on lines of sight L_1, L_2, L_3 . But where?

the object might be from the Earth. Each observation defines nothing more than a “line-of-sight,” a direction in which the object was seen. We can represent this situation as follows (**Figure 11.1**): From each of three points, E_1, E_2, E_3 , representing the positions of the Earth (or more precisely, of Piazzi’s observatory) at the three times of observation, draw “infinite” lines L_1, L_2, L_3 , each in

BOX I. The position of P_2 is related to that of P_1 and P_3 , by a parallelogram, formed from displacements OQ_1 and OQ_3 , along the axes OP_1 and OP_3 , respectively.

Points Q_1 and Q_3 divide the segments OP_1 and OP_3 according to proportions which can be expressed in terms of the triangular areas T_{12}, T_{23} , and T_{13} . In fact, from the discussion in Chapter 10, we know that

$$\frac{OQ_1}{OP_1} = \frac{T_{23}}{T_{13}}, \text{ and}$$

$$\frac{OQ_3}{OP_3} = \frac{T_{12}}{T_{13}}.$$

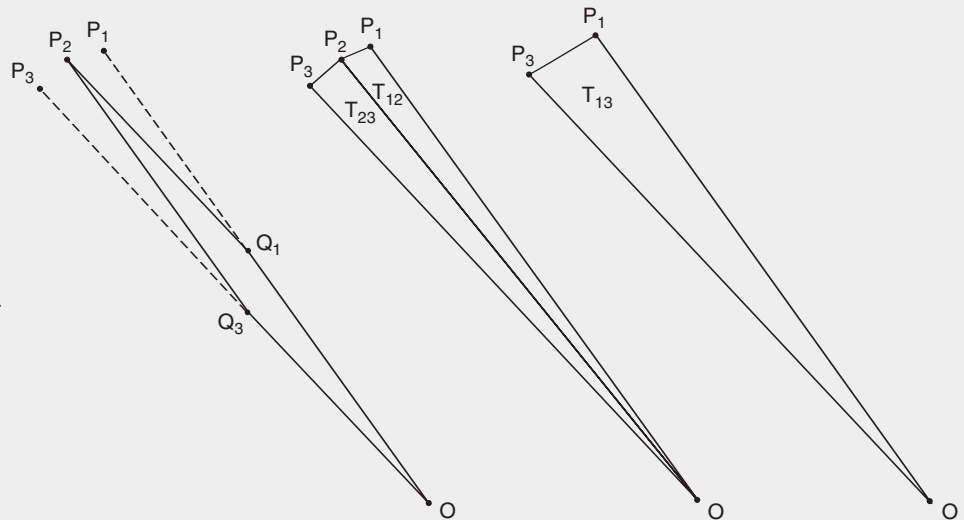
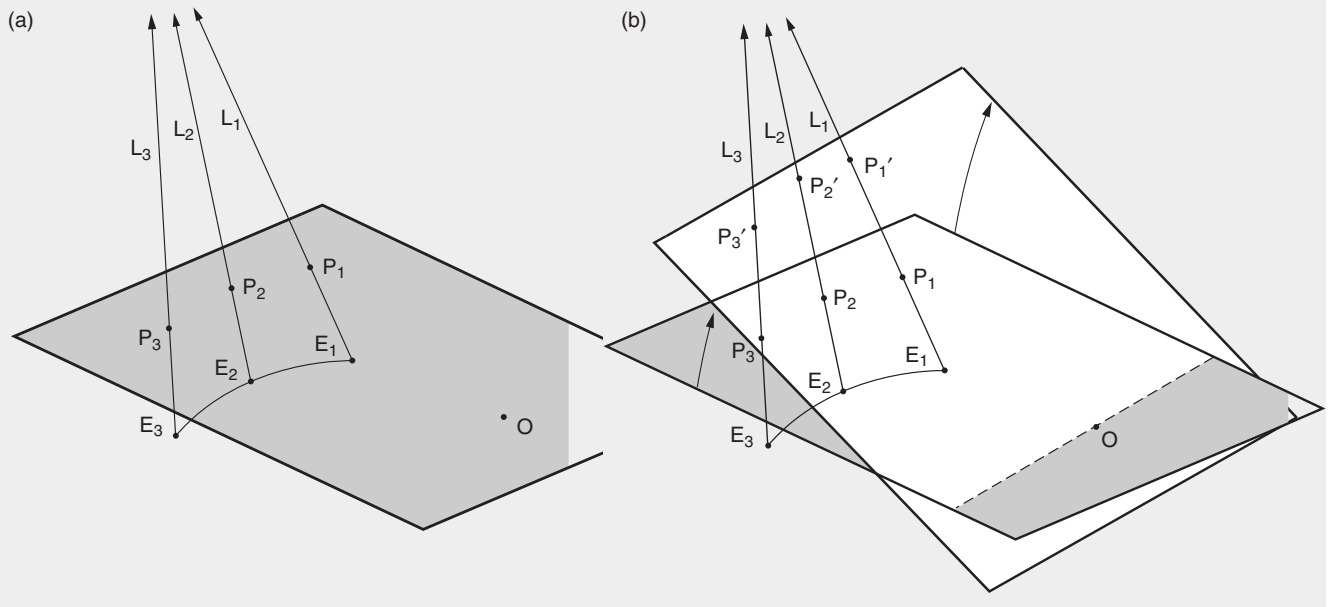

FIGURE 11.2. (a) P_1, P_2, P_3 , which are positions on Ceres' orbit, must all lie in some plane passing through the sun. (b) Each hypothetical position of the orbital plane defines a different configuration of positions P_1, P_2, P_3 relative to each other.



the direction in which Ceres was seen at the corresponding time. Concerning the actual positions in space of Ceres (positions we have designated P_1, P_2, P_3), the observations tell us only, that P_1 is located somewhere along L_1 , P_2 is somewhere on L_2 , and P_3 is somewhere on L_3 . For an empiricist, the distances along those lines remain completely indeterminate.

We, however, know more. If Ceres belongs to the solar system, its motion must be governed by the harmonic ordering of that system, as expressed (in part) by the Gauss-Kepler constraints. Those constraints reflect the curvature of the space-time, within which the events recorded by Piazzi occurred, and relative to which we must “read” his observations.

According to Gauss’s first constraint, the orbit of Ceres is confined to some *plane* passing through the center of the sun. This simple proposition, should already transform our “reading” of the observations. The three positions P_1, P_2, P_3 , rather than simply lying “somewhere” along the respective lines, are the points of intersections of the three lines L_1, L_2, L_3 with a certain plane passing through the sun. (**Figure 11.2a**) We don’t yet know which plane this is; but, the very occurrence of an intersection of that form, already greatly reduces the degree of indeterminacy of the problem, and introduces a relationship between the three (as yet unknown) positions and distances.

Indeed, imagine a variable plane, which can pivot around the center of the sun; for each position of that plane, we have three points of intersection, with the lines L_1, L_2, L_3 . Consider, how the *configuration* of those three

points, relative to each other and the sun, *changes* as a function of the variable “tilt” of the plane. (**Figure 11.2b**) Can we specify something characteristic about the geometrical relationship among the three actual positions P_1, P_2, P_3 of Ceres, which might distinguish that specific group of points *a priori* from all other “triples” of points, generated as intersections of the three given lines with an arbitrary plane through the center of the sun?

Thanks to the work of the last chapter, we already have part of the answer. (**Box I**) We found, that the second position of Ceres, P_2 , is related to the first and third positions P_1 and P_3 , by the existence of a *parallelogram*, whose vertices are O, P_2 , and two points Q_1 and Q_3 , lying on the axes OP_1 and OP_3 respectively. Furthermore, we discovered that the *positions* Q_1 and Q_3 , defining those two displacements, can be precisely characterized in terms of ratios of the triangular areas spanned by the positions P_1, P_2, P_3 (and O).

Henceforth, we shall sometimes refer to the values of those ratios, $T_{23}:T_{13}$ and $T_{12}:T_{13}$ (or, T_{23}/T_{13} and T_{12}/T_{13}), as “coefficients,” determining the interrelation of the three positions in question.

We already observed in the last chapter, that the triangular areas entering into these relationships, are *nearly* the same as the orbital sectors swept out by the planet in moving between the corresponding positions; and, whose ratios are *known* to us, thanks to Kepler’s “area law,” as ratios of elapsed times. In fact, we calculated them in the last chapter from Piazzi’s data.

The area of each orbital sector, however, *exceeds* that of

the corresponding triangle, by the lune-shaped area, enclosed between the orbital arc and the straight-line segment connecting the corresponding two positions of the planet.

As long as the three positions of the planet are relatively close together—as they are in the case of Ceres at the times of Piazzi’s observations—the lune-shaped excesses amount to only a small fraction of the areas of the triangles (or sectors). In that case, the ratios of the triangles $T_{23}:T_{13}$ and $T_{12}:T_{13}$ would be “very nearly” equal to the ratios of the corresponding orbital sectors, $S_{23}:S_{13}$ and $S_{12}:S_{13}$, whose values we calculated in the preceding chapter.

Can we regard the small difference between the triangle and sector ratios, as an “acceptable margin of error” for the purposes of a first approximation? If so, then we could take the numerical values calculated in Chapter 10 from the ratios of the elapsed times, and say:

$$\frac{T_{23}}{T_{13}} = (\text{approximately}) \frac{S_{23}}{S_{13}} = 0.513,$$

$$\frac{T_{12}}{T_{23}} = (\text{approximately}) \frac{S_{12}}{S_{23}} = 0.487.$$

Let us suppose, for the moment, that these equations were exactly correct, or very nearly so. What would they tell us, about the configuration of the three points P_1, P_2, P_3 ?

To get a sense of this, readers should perform the following graphical experiment: Choose a fixed point O , to represent the center of the sun, and choose *any* two other points as hypothetical positions for P_1 and P_3 . Next, determine the corresponding positions of Q_1 and Q_3 on the segments OP_1 and OP_3 , so that OQ_1 is 0.513 times the total length of OP_1 , and OQ_3 is 0.487 times the total length of OP_3 . Combine the displacements OQ_1 and OQ_3 according to the “parallelogram law,” to determine a position for P_2 . Now, change the positions of P_1 and P_3 , and see how P_2 changes. What remains constant in the relationship between P_2, P_1 , and P_3 ? Also, examine the effect, of replacing the “coefficients” just used, by some other pair of values, say 0.6 and 0.9.

Evidently, by *specifying* the values of the ratios in terms of which the position of P_2 is determined by those of P_1 and P_3 , we have *greatly restricted* the range of “possible” triples of points, which could qualify as the three actual positions for Ceres.

Recall the image of a manifold of “triples” of points, generated as the intersections of a variable plane, passing through the center of the sun, with the three “lines of sight” L_1, L_2, L_3 . (SEE Figure 11.2) How many of those triples manifest the specific type of relationship of the second upon the first and third, defined by those specific values for the coefficients? Exploring this question by drawings and examples, we soon gain the conviction, that—

apart from very exceptional cases in terms of the lines L_1, L_2, L_3 , and the specified values of the coefficients—the specified type of configuration is realized for only *one* position of the movable plane. Thus, the positions of the three points in question, are practically uniquely determined, once L_1, L_2, L_3 and the “coefficients” are given.

If that is the case, then the task we have set ourselves must, intrinsically, be capable of solution! In particular, there must be a way to determine the Earth-Ceres distances from nothing more than the directions of the lines L_1, L_2, L_3 (as given by Piazzi’s observations), the positions of the Earth, and sufficiently accurate values for the coefficients defined above.

To see how this might be accomplished, reflect on the implications of the parallelogram expressing the interrelationship between the second, and the first and third positions of Ceres. (SEE Box I) That parallelogram expresses the circumstance, that the (as yet unknown) position of P_2 , results from a combination of the two displacements OQ_1 and OQ_3 . Concerning the positions of Q_1 and Q_3 , we know that they lie on the segments OP_1 and OP_3 , respectively, and divide those segments according to proportions (“coefficients”) whose values are known to us, at least in approximation. (**Figure 11.3**) Unfortunately, since we don’t know P_1 and P_3 , we have no way to directly determine the positions of Q_1 and Q_3 in space.

Let us look into the situation more carefully. Consider, first, the displacement OQ_1 in relation to the positions of the sun, Earth, and Ceres at the first moment of observation. Those positions form a triangle, whose sides are

FIGURE 11.3. *Closing in on P_2 . The proportional relationships of Q_1, Q_3 to OP_1, OP_3 are known approximately from the ratios of elapsed times.*

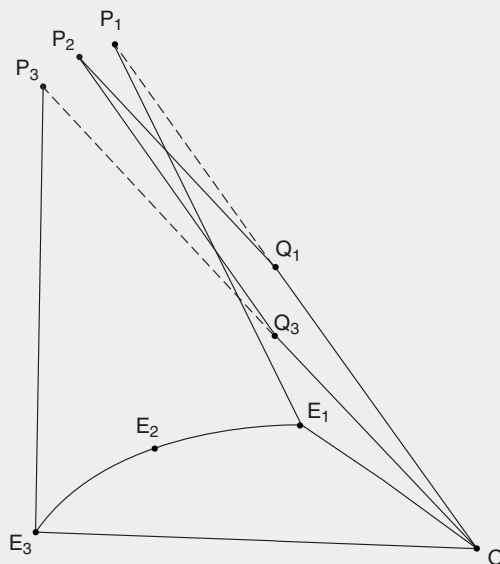
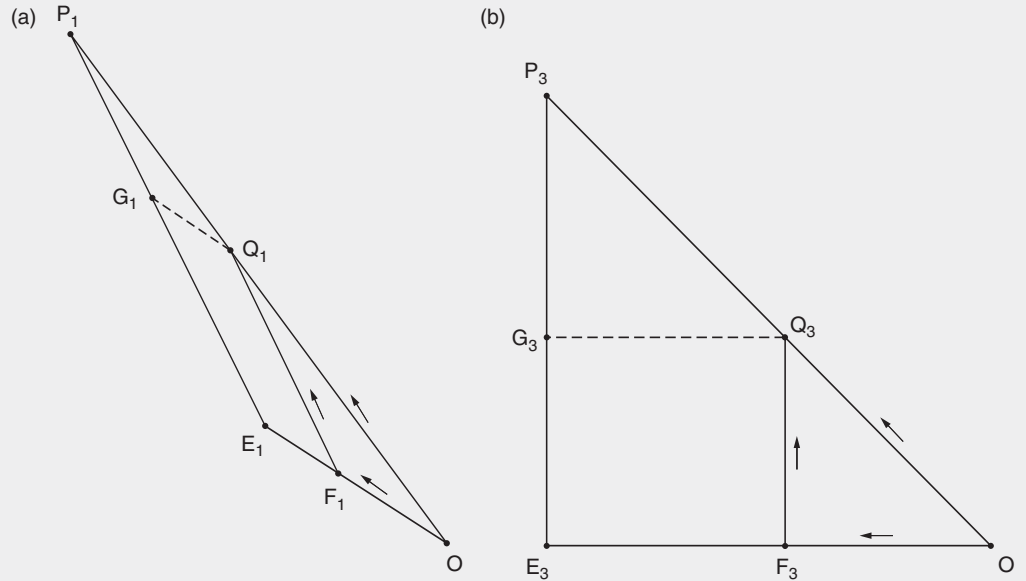

FIGURE 11.4. Closing in on P_2 . Determining (a) F_1 and the direction of F_1Q_1 , and (b) F_3 and the direction of F_3Q_3 .



OE_1 , OP_1 and E_1P_1 . (Figure 11.4a) Point Q_1 lies on one of those sides, namely OP_1 , dividing it according to the proportion defined by the first coefficient. However, we can't say anything about the lengths of OP_1 and E_1P_1 , nor about the angle between them, so the position of Q_1 remains undetermined for the moment.

But what about the points, which correspond to Q_1 on the *other* sides of the triangle? Draw the parallel to the line-of-sight E_1P_1 , through Q_1 down to OE_1 . That parallel intersects the axis OE_1 at a location, which we shall call F_1 . That point F_1 will divide the segment OE_1 by the *same* proportion, that Q_1 divides OP_1 (for, by construction,

BOX II. The position of P_2 results from the combination of the displacements OQ_1 and OQ_3 . On the other hand, by our constructions,

$$OQ_1 = OF_1 + F_1Q_1, \text{ and } OQ_3 = OF_3 + F_3Q_3.$$

Combine displacements OF_1 and OF_3 , to get a position F , and then perform the other two displacements, F_1Q_1 and

F_3Q_3 . This amounts to constructing a parallelogram based at F whose sides are parallel to, and congruent with, the segments F_1Q_1 and F_3Q_3 . The directions of the latter segments are parallel to Piazzoli's "lines of sight" from E_1 to P_1 and E_3 to P_3 , respectively. The end result must be P_2 . This tells us that P_2 lies in the plane through F , determined by those two "line of sight" directions.

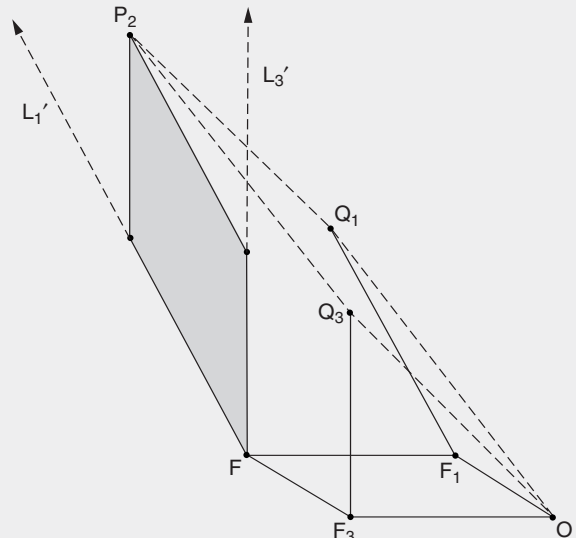
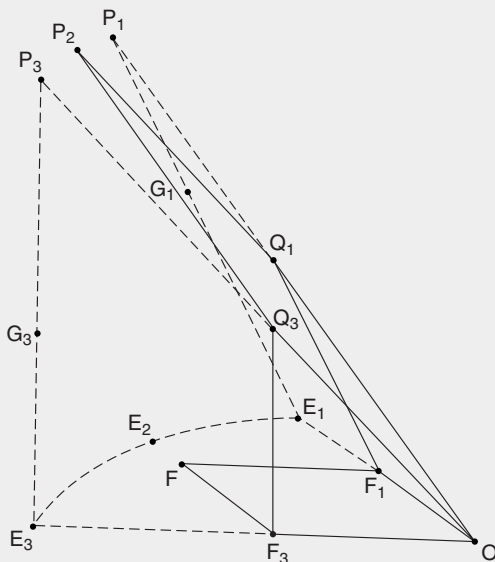

OF_1Q_1 and OE_1P_1 are similar triangles). That proportion, as we noted, is at least approximately known. Since the position of the Earth, E_1 , is known, *we can determine the position of F_1 directly*, by dividing the known segment OE_1 according to that same proportion.

This result brings us, by implication, a dimension closer to our goal! Observe, that—by construction—the segment F_1Q_1 is parallel to, and congruent with, a sub-segment of the line-of-sight E_1P_1 . Call that sub-segment E_1G_1 . In other words, to arrive at the location of Q_1 from O , we can first go from O to the position F_1 , just constructed, and then carry out a second displacement, equivalent to the displacement E_1G_1 but applied to F_1 instead of E_1 . We don't know the magnitude of that displacement, but *we do know its direction*, which is that of the line of sight L_1 given by Piazzi's first observation.

Now, apply the very same considerations, to the positions for the third moment of observation (i.e., the triangle OE_3P_3). (**Figure 11.4b**) Dividing the segment OE_3 according to the value of the second coefficient, determine the position of a point F_3 on the line OE_3 , such that the line F_3Q_3 is parallel with the line-of-sight E_3P_3 . The displacement OQ_3 is thus equivalent to the combination of OF_3 , and a displacement in the direction defined by the line of sight E_3P_3 , i.e., L_3 .

We are now inches away from being able to determine the position of P_2 ! Recall, that we resolved the displacement OP_2 into the combination of OQ_1 and OQ_3 . Each of the latter two displacements, on the other hand, has now

been decomposed, into a known displacement (OF_1 and OF_3 , respectively), and a displacement along one of the directions determined by Piazzi's observations. In other words, OP_2 is the result of *four* displacements, of which two are known in direction and length, and the other two are known only as to direction. (**Box II**)

Assuming, as we did from the outset, that *the result of a series of displacements of this type, does not sensibly depend on the order in which they are combined*, we can imagine carrying out the four displacements, yielding the position of P_2 relative to O , in the following way: First, combine the displacements OF_1 and OF_3 . The result is a point F , located in the plane of the ecliptic. We can determine the position of F directly from the known positions F_1 and F_3 . Then, apply the two remaining displacements, to get from F to P_2 .

What does that say, about the nature of the relationship of P_2 to F ? We don't know the magnitudes of the displacements carrying us from F to P_2 , but we know their two directions. They are the directions defined by Piazzi's original lines of sight, L_1 and L_3 . *Aha!* Those two directions, as projected from F , define a *specific plane* through F . We have only to draw parallels L'_1 , L'_3 through F , to the just-mentioned lines of sight; the plane in question, plane Q , is the plane upon which L'_1 and L'_3 lie. (**Figure 11.5**) Since that plane contains both of the directions of the two displacements in question, their combined result, starting from F —i.e., P_2 —will in any

FIGURE 11.5. P_2 must lie on plane Q constructed at point F . But where?

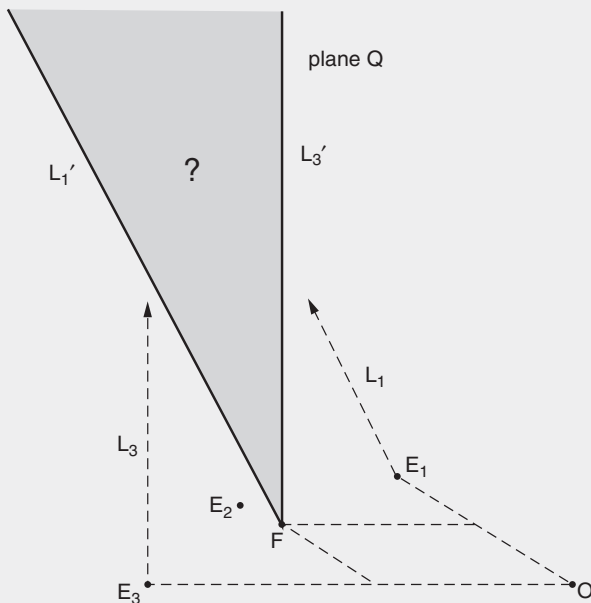
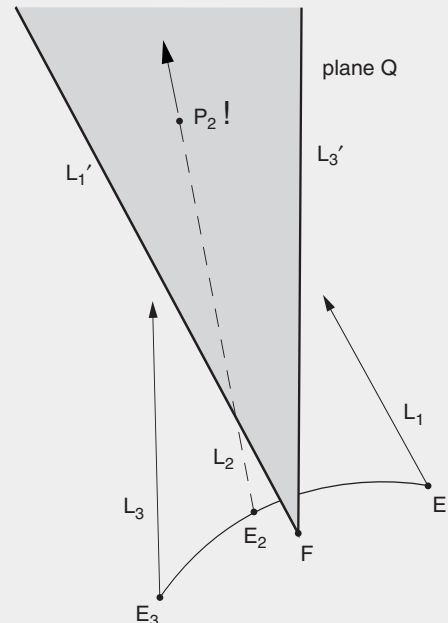

FIGURE 11.6. Locating P_2 . Line L_2 , originating at E_2 , must intersect plane Q at point P_2 . E_2P_2 is the crucial distance we are seeking.



case be some point in that plane.

So, P_2 lies on that plane. But where? Don't forget the second of the selected observations of Piazzi! That observation defines a line L_2 , extended from E_2 , along which P_2 is located. Where is it located? Evidently, *at the point of intersection of L_2 with the plane which we just constructed!* (Figure 11.6) The distance along L_2 , between E_2 and that point of intersection (i.e., the distance E_2P_2), is the crucial distance we are seeking. *Eureka!*

This—with one, *very crucial* addition by Gauss—defines the kernel of a method, by which we can actually calculate the Earth-Ceres distance. It is only necessary to translate the geometrical construct, just sketched, into a

form which is amenable to precise computations.

However, the pathway of solution we have found so far, has one remaining flaw. We shall discover that, and Gauss's ingenious remedy, in Chapter 12.

In the meantime, readers should ponder the following: The possibility of determining the position of P_2 , as the intersection of the line L_2 with a certain plane through F , presupposes, that F does not coincide with the origin of that line, namely E_2 . In fact, the size of the gap between F and E_2 , reflects the difference in curvature between the orbits of Earth and Ceres, over the interval from the first to the third observations.

—JT

CHAPTER 12

An Unexpected Difficulty Leads to New Discoveries

In Chapter 11, we appeared to have won a major battle in our efforts to determine the orbit of Ceres from three observations. The war, however, has not yet been won. As we soon shall see, the greatest challenge still lies before us.

We developed a geometrical construction that gives us

FIGURE 12.1. Relationships of the positions of the sun (O), Earth (E_1, E_2, E_3), lines of sight, and Ceres (P_1, P_2, P_3).

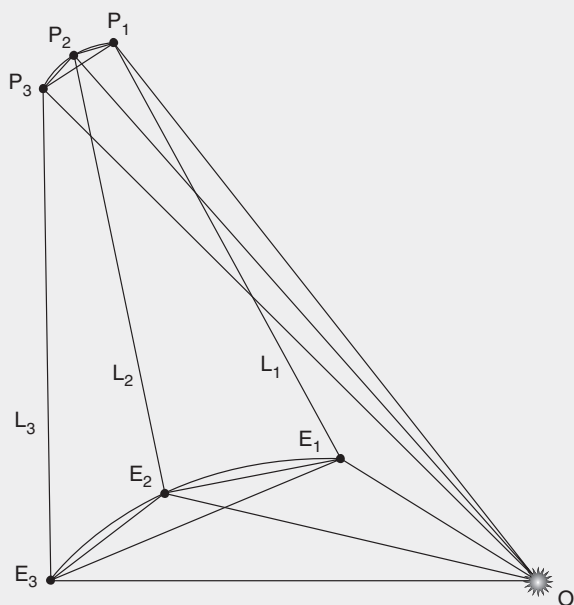

an approximation for the second position of Ceres. That construction consisted of the following essential steps:

1. The three chosen observations define the directions of three “lines-of-sight” from Piazzi’s observatory through the positions of Ceres, at each of the given times of observation. Using that information, and the known orbit and rotational motion of the Earth, determine the positions of the observer, E_1, E_2, E_3 , and construct lines L_1, L_2, L_3 , running from each of those positions in the corresponding directions.* (Figure 12.1)
2. From the times provided for Piazzi’s observations, compute the ratios of the elapsed times, between the first and second, the second and third, and the first and third times—i.e., the ratios $t_2 - t_1 : t_3 - t_1$ and $t_3 - t_2 : t_3 - t_1$.
3. According to Kepler’s “area law,” the values, just computed, coincide with the ratios of the sectoral areas, $S_{12} : S_{13}$ and $S_{23} : S_{13}$, swept out by Ceres over the corresponding time intervals. We *assumed*, that for the pur-

* For reference, Piazzi gave the apparent positions for Jan. 2, Jan. 22, and Feb. 11, 1801, as follows:

	right ascension	declination
Jan. 2	51° 47' 49"	15° 41' 5"
Jan. 22	51° 42' 21"	17° 3' 18"
Feb. 11	54° 10' 23"	18° 47' 59"

Those “positions” are nothing but the directions in which the lines L_1, L_2, L_3 are “pointing.”

pose of approximation, it would be possible to ignore the relatively small discrepancy between the ratios of the *orbital sectors* on the one hand, and those of the corresponding *triangular areas* formed by the sun and the corresponding positions of Ceres, on the other. (Figure 12.2)

- On that basis, we assumed that the ratios of the elapsed times, computed in step 2, provide “sufficiently precise” *approximations* to the values for the ratios of the triangular areas, $T_{12}:T_{13}$ and $T_{23}:T_{13}$. The true values of those ratios, which I shall refer to as “*d*” and “*c*,” respectively, are the coefficients which define the spatial relationship of the *second* position of Ceres to the *first* and *third* positions, in terms of the “parallelogram law” for the combination and decomposition of simple displacements in space.
- Using the approximate values for *c* and *d* adduced from the elapsed times in the manner just described, construct a position *F*, in the plane of the Earth’s orbit, in such a way, that *F*’s relationship to the Earth positions E_1 and E_3 , is the same as that adduced to exist between the *second*, and *first* and *third* positions of Ceres.

To spell this out just once more: Divide the lengths of the segments from the sun to the Earth, OE_1 and

FIGURE 12.2. *Orbital sectors* S_{12}, S_{23}, S_{13} and corresponding *triangular areas* T_{12}, T_{23}, T_{13} .

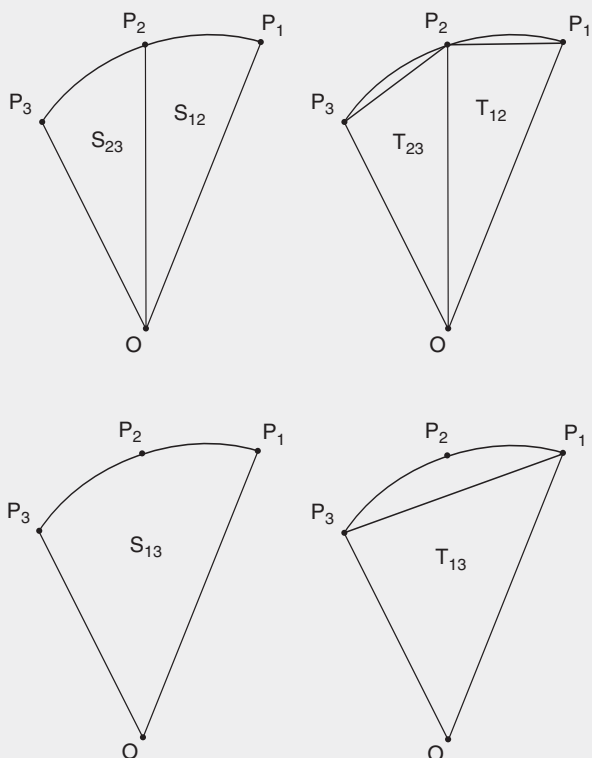
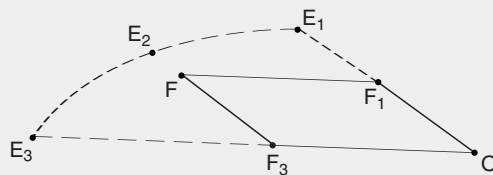

FIGURE 12.3. *Determining point F, as a combination of displacements along* OE_1 *and* OE_3 .



OE_3 , according to the ratios defined by the approximate values for the coefficients *c* and *d*. In other words, construct points F_1 and F_3 , along the segments OE_1 and OE_3 , respectively, in such a way, that $OF_1/OE_1 = t_3 - t_2 / t_3 - t_1$ and $OF_3/OE_3 = t_2 - t_1 / t_3 - t_1$. Then, construct *F* as the endpoint of the resultant of the two displacements OF_1 and OF_3 . (Thus, *F* will be the fourth vertex of the parallelogram constructed from points O, F_1 , and F_3 .) (Figure 12.3)

- Next, draw lines L_1', L_3' parallel to the lines L_1 and L_3 , through *F*. The resulting lines determine a unique plane, *Q*, passing through *F*.
- Determine the point *P*, where the line L_2 intersects the plane *Q*. In other words, “project” from the second position E_2 of the Earth, along the “line of sight” defined by the second observation, until you hit the plane *Q*. (Figure 12.4) That point, *P*, is our first approximation for the Ceres position P_2 !

FIGURE 12.4. *The intersection of line* L_2 *with plane* *Q*, *determines point* P_2 .

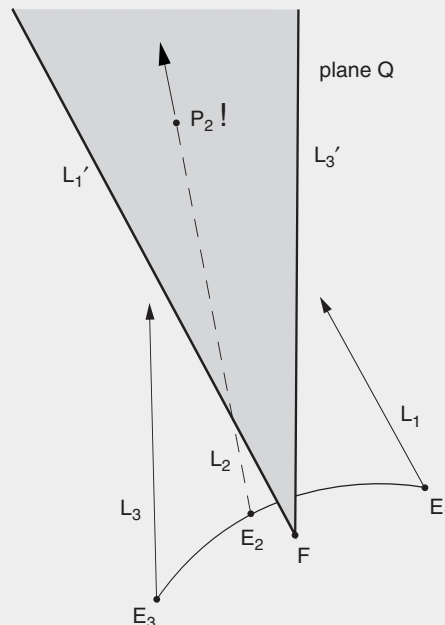

Using routine methods of analytical and descriptive geometry, as developed by Fermat and perfected by Gaspard Monge *et al.*, we can translate the geometrical construction, sketched above, into a procedure for numerical computation of the distance E_2P , from the data provided by Piazzi.

We would be well advised, however, to think twice before launching into laborious calculation. As it stands, our method is based on a crude approximation for estimating the values of the crucial coefficients, c and d . Remember, we chose to ignore the differences between the orbital sectors and the corresponding triangles. We might argue for the admissibility of that step, for the purposes of approximation, as follows.

Firstly, we are concerned only with the ratios, and not the absolute magnitudes of the sectors and triangles. Secondly, the differences in question—namely the lune-shaped areas contained between the orbital arcs and the straight-line chords connecting the corresponding orbital positions—are certainly only a tiny fraction of the *total* areas of the orbital sectors. Hence, they will have only a “marginal” effect on the values of the *ratios* of those areas.

In fact, simple calculations, carried out for the hypothetical assumption of a circular orbit between Mars and Jupiter,* indicate, that we can expect an error on the order of about *one-fourth of one percent* in the determination of the coefficients c and d , when we disregard the

difference between the sectors and the triangles. Not bad, eh?

Before celebrating victory, however, let us look at the possible effect of that magnitude of error in the coefficients, for the rest of the construction.

Look at the problem more closely. An error of x percent in the values of c and d , will produce a corresponding percentual error in the positions of F_1 and F_2 , and at most twice that error, in the process of combining OF_1 and OF_2 to create F . Any error in the position of F , however, produces a corresponding shift in the position of the plane Q , whose intersection with L_2 defines our approximation to the position of Ceres. Now, the *directions* of the lines L_1, L_2, L_3 , which arose from observations made over a relatively short time, differ only by a few degrees. Since the orientation of the plane Q is determined by parallels to L_1 and L_3 at F , this means that L_2 will make an extremely “flat” angle to the plane Q . A slight shift in the position of the plane, yields a *much larger* change in the location of its intersection with L_2 . How much larger? If we analyze the relative configuration of L_2, Q , and the ecliptic, corresponding to the situation in Piazzi’s observations, then it turns out that any error in the position of F , can generate an error *ten to twenty times larger* in the location of the intersection-point. (**Figure 12.5**) That would bring us into the range of a worrisome 5-10 percent error in our estimate for the Earth-Ceres distance E_2P_2 .

* To get a sense, how large that supposedly “marginal” error might be, let us work out a hypothetical case. Suppose that the unknown planet were moving in a circular orbit, about halfway between Mars and Jupiter; say, at a distance of 3 Astronomical Units (A.U.) from the sun (three times the mean Earth-sun distance). According to Kepler’s constraints, the square of the periodic time (in years) of any closed orbit in the solar system, is equal to the cube of the major axis of the orbit (in A.U.). The periodic time for the unknown planet, in this case, would be the square root of $3 \times 3 \times 3$, or about 5.196152 (years). In a period of 20 days (i.e., approximately the time between the successive observations selected by Gauss), the planet would traverse a certain fraction of a total revolution around the sun, equivalent to 20 divided by the number of days in the orbital period of 5.196152 years, i.e., $20/(365.256364 \times 5.196152)$, or 0.010538. To find the area of the orbital sector swept out during 19 days, we have only to form the product of 0.010538 and the area enclosed by a total revolution—the latter being equal to π (~ 3.141593) times the square of the orbital radius (3×3). We get a result of 0.297951, in units of square A.U.

Next, compute the triangular area between the sun and two positions of the planet, 20 days apart. The angle swept out at the sun by that motion, is $0.010538 \times 360^\circ$, or 3.79368° . The height and base of the corresponding isosceles triangle, whose longer sides are equal to the orbital radius, can be estimated by graphical means, or computed with the help of sines and cosines. The triangle is found

to have a height of 2.998356 A.U. and a base (the chord between the two planetary positions) of 0.198600 A.U., for an area of 0.297737 square A.U.

Comparing the values just obtained, we find the excess area of the orbital sector over the triangle, to be a “mere” 0.000214 square A.U. (Given that an astronomical unit is 150 million kilometers, that “tiny” area corresponds to “only” about 5 trillion square kilometers!) More to the point, the ratio of the sector to the triangular area is 1.000718. Thus, in replacing the triangular areas T_{12} and T_{23} by the corresponding sector areas S_{12} and S_{23} , in the ratios which define the coefficients c and d , we introduce an error of about 0.07 percent.

Note, however, that these estimates only apply to an elapsed time of the order of 20 days—such as between the first and second, and the second and third positions. The first and third positions, on the other hand, are about 40 days apart; calculating this case through, we find an orbital sector area of 0.595902 and a triangular area of 0.594170 square A.U. In this case, the difference is 0.00193 square A.U.—almost *eight times* what it was in the earlier case!—and the ratio is 1.0029, corresponding to a proportional error of more than 0.29 percent. This is the error to be expected, when we use S_{13} instead of T_{13} in the ratios defining the coefficients c and d .

From these exploratory computations, we conclude that by far the largest source of error, in our estimate of the coefficients c and d , is due to the discrepancy between S_{13} and T_{13} .

FIGURE 12.5. Owing to the extremely flat angle which the line L_2 makes to the plane Q , a slight shift in the position of F (from F to F') causes a much larger change in the point of intersection with L_2 (from P_2 to P_2').

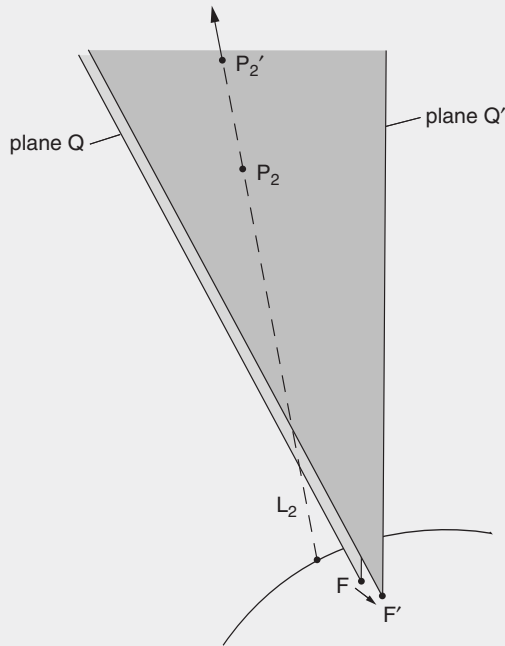

As a matter of fact, our calculation with circular orbits *greatly* underestimates the error in the coefficients c and d , which would occur in the case of a significantly *non-circular* orbit (as is the case for Ceres). In that case, the error can amount to 2 percent or more, leading to a final error of 20-30 percent in our estimate of the object's distance.

Such a huge margin of error would render any prediction of the position of Ceres completely useless.

Back to Curvature

Reality has rejected the crudeness of our approach, in trying to ignore the discrepancies between the orbital sectors and the corresponding triangles. Those discrepancies are, in fact, the most crucial characteristics of the orbit itself

“in the small”; they result from the curvature of the orbit, as reflected in the elementary fact, that the path of the planet between any two points, no matter how close together, is always “curving away from” a straight line.*

To come to grips with the problem, no less than *three levels* of the process must be taken into account:

(i) The curvature “in the infinitely small,” which acts in any arbitrarily small interval, and continuously “shapes” the orbit at every moment of an ongoing process of generation.

(ii) The curvature of the orbit “in the large,” considered as a “completed” totality “in the future,” and which ironically pre-exists the orbital motion itself; this, of course as defined in the context of the solar system as a whole.

(iii) The geometrical intervals among discrete loci P_1 , P_2 , etc., of the orbit, as moments or events in the process, and whose relationships embody a kind of *tension* between the apparent cumulative or integrated effect of curvature “in the small,” and the curvature “in the large”—acting, as it were, from the future.

Euler, Newton, and Laplace rejected this, linearizing both in the small and in the large. From the standpoint of Newton and Laplace, the orbit *as a whole*—history!—has no *efficient* existence. An orbit is only the accidental trace of a process which proceeds “blindly” from moment to moment under the impulse of momentary “forces”—like the “crisis management” policies of recent years! For the Newtonian, only “force”, which you can “feel” in the “here and now,” has the quality of reality. But Newtonian “blind force” is a purely linear construct, devoid of cognitive content. You can travel the entropic pathway of deriving the “force law” algebraically from Kepler’s Laws; but, in spite of elaborate efforts of Laplace *et al.*, it is axiomatically impossible to derive the Keplerian ordering of the solar system as a whole, from Newton’s physics.

In fact, the efforts of Burkhardt and others, to determine the orbit of Ceres using the elaborate mathematical apparatus set forth by Laplace in his famous *Mécanique Céleste*, proved a total failure. According to the report of Gauss’s friend, von Zach, the elderly Laplace, who— from the lofty heights of Olympus, as it were—had been following the discussions and debates concerning Ceres, concluded that it was *impossible* to determine the orbit

* Industrious readers, who took the trouble to actually plot the position of F , using the ratios of elapsed times as described above, will have discovered, that F lies on the *straight line* between E_1 and E_3 . One might also note the following:

- (i) As long as we use the ratios of elapsed times as our coefficients, the sum of those coefficients will invariably be equal to 1.
- (ii) If we have any two points A and B , divide the segments OA

and OB according to coefficients whose sum is equal to 1, and generate the corresponding displacements along those two axes. The point resulting from the combination of those displacements, will always lie along the straight line joining A and B .

(iii) Consequently, insofar as P_2 does *not* lie on the segment P_1P_3 , in virtue of the curvature of Ceres’ orbit, the sum of the *true* values of c and d , will always be different from, and, in fact, greater than 1.

from Piazzi's limited data. Laplace recommended calling off the whole effort, waiting until some astronomer, by luck, might succeed in finding the planet again. When von Zach reported the results of Gauss's orbital calculation, and the extraordinary agreement between Gauss's proposed orbit and the entire array of Piazzi's observations, this was pooh-poohed by Laplace and his friends. But reality soon proved Gauss right.

Characteristic of the axiomatic superiority of Gauss's method, as of Kepler before him, is that Gauss treats the orbits as efficient entities. Accordingly, let us investigate the relationships among P_1, P_2, P_3 , which necessarily ensue from the fact that they are subsumed as moments of a unique Keplerian orbit.

A Geometric Metaphor

For this purpose, construct the following representation of the manifold of all potential orbits (seen as "completed" totalities), having a common focus at the center of the sun, and lying in any given plane. (**Figure 12.6**) Represent that plane as a horizontal plane, passing through a point O , representing the center of the sun. Above the plane, generate a circular cone, whose vertex is at O , and whose axis is the perpendicular to the plane through O .

Cutting the cone by another, variable plane, we generate the entire array of conic sections. The perpendicular

projection of each such conic section, down onto the horizontal plane, will also be a conic section; and the resulting conic sections in the horizontal plane will all have the point O as a common focus.* (SEE "The Ellipse as a Conical Projection," in the **Appendix**)

This construction can be "read" as a geometrical metaphor, juxtaposing two different "spaces" that are axiomatically incompatible. In this metaphor, the cone represents the invisible space of the process of creation (which Lyndon LaRouche sometimes calls the "continuous manifold"), while the horizontal plane represents the space of visible phenomena. The projected conic section is the visible, "projected" image of a singularity in the higher space.

Using this construction, examine the relationship among P_1, P_2, P_3 , and the unique orbit upon which P_1, P_2, P_3 lie. We can determine that orbit by "inverse projection," as follows. (**Figure 12.7**)

At each of P_1, P_2, P_3 , draw a perpendicular to the horizontal plane. Those three perpendiculars intersect the cone at corresponding points, U_1, U_2, U_3 . The latter points, in turn, determine a unique plane, cutting the cone through those points and generating a conic section containing them. The projection of that conic section onto the "visible" horizontal plane, will be the unique orbit upon which P_1, P_2, P_3 lie. Note, that the heights h_1, h_2, h_3 of the points U_1, U_2, U_3 above the horizontal plane are proportional to the radial distances of P_1, P_2, P_3 from the origin O .

Note an additional singularity, generated in the process: The plane through U_1, U_2, U_3 intersects the axis of the cone at a certain point, V . The *height* of that point on the axis above O , is, in fact, closely related to the

* I first presented the basic idea of this construction in an unpublished April 1983 paper entitled "Development of Conical Functions as a Language for Relativistic Physics."

FIGURE 12.6. Construct a circular cone with apex at point O , the position of the sun in a horizontal plane. By cutting the cone with a second plane, we generate an ellipse. When projected down onto the horizontal plane, this ellipse will generate a corresponding, second ellipse. We shall use this construction to investigate the relationships of the orbital sectors and triangular areas formed by the observed positions of Ceres.

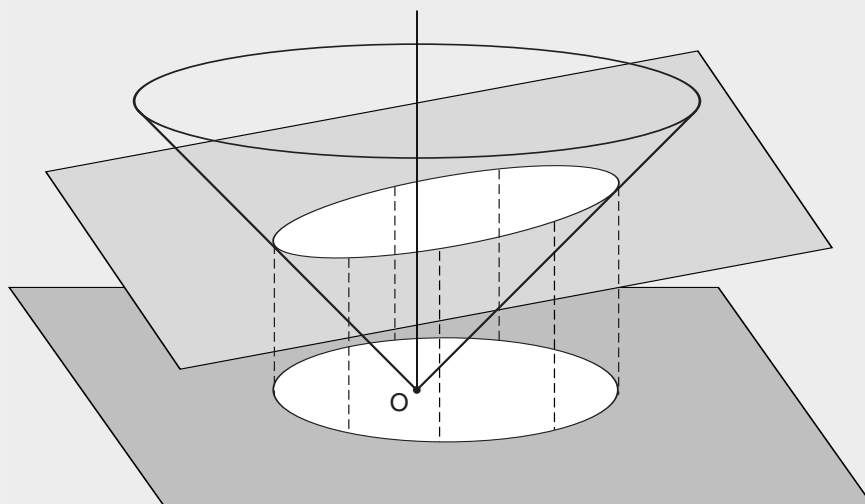

FIGURE 12.7. Use our construction to relate positions P_1, P_2, P_3 , radial distances r_1, r_2, r_3 , heights h and h_1, h_2, h_3 , and the orbital parameter.

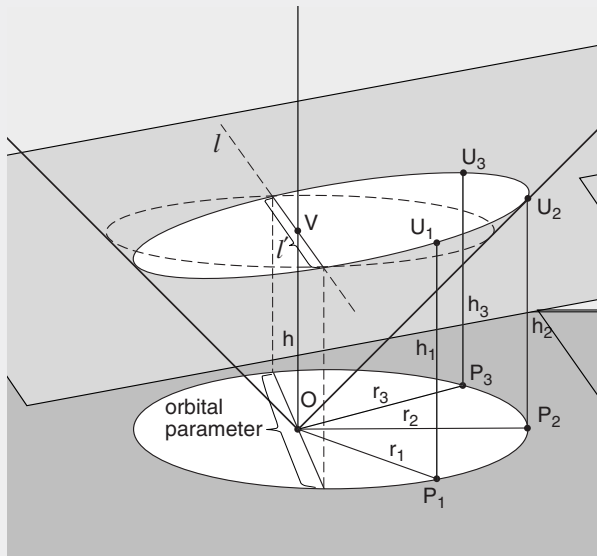
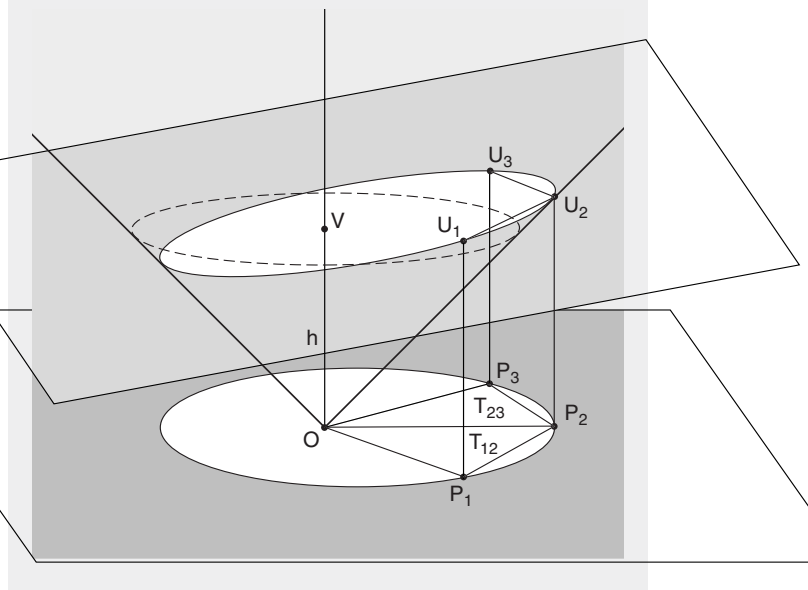

FIGURE 12.8. What is the relationship between the triangular areas T_{12}, T_{23}, T_{13} and height h of the point V ?



“parameter” of the orbit, which played a key role in Gauss’s formulation of Kepler’s constraints. Gauss showed, that the area swept out by a planet in its motion in a given orbit over any interval of time, is proportional (by a universal constant of the solar system) to the duration of the time interval, multiplied by the square root of the “orbital parameter.” Integrating this with the conical representation that we have just introduced, opens up a new pathway toward the solution of our problem.

In fact, if we cut the cone horizontally at the height of V , then the intersection of that horizontal with the plane of U_1, U_2, U_3 , will be a line l , perpendicular to the main axis of the conic section. That line l intersects the conic section in two points, which lie symmetrically on opposite sides of V and at the same height. The segment l' of l (bounded by those points) defines the cross-width of the conic section at V . Line segment l' is also a diameter of the cone’s circular cross-section at V , which in turn is proportional to the height h of V on the axis. Now, project down to the horizontal plane of P_1, P_2, P_3 . The image of l' , equivalent to l' in length, is the perpendicular diameter of the orbit at the focus O , exactly the length that Gauss called the “parameter” of the orbit.

All of this can be seen, nearly at a glance, from the diagram in Figure 12.6. The immediate upshot is, that Gauss’s “orbital parameter,” which governs the relationship between the elapsed time and the area swept out by the motion of a planet in its orbit, is proportional to the h of the point V on the axis of the cone.

On the other hand, our method of “inverse projection” allows us to determine V directly in terms of the three positions P_1, P_2, P_3 , by constructing the plane through the corresponding points U_1, U_2, U_3 . As a “spin-off” of these considerations, we obtain a simple way to determine Gauss’s orbital parameter for any orbit, from nothing more than the positions of any three points on the orbit. We can say even more, however.

We found, earlier, a way to express the spatial relationship between P_1, P_2, P_3 (relative to O), in terms of the ratios of the triangular areas T_{12}, T_{23}, T_{13} . This points to the existence of a simple functional relationship between those triangular areas, and the value of the orbital parameter (or, equivalently, the height of V). The latter, in turn, is functionally related to the values of corresponding times and orbital sectors, by Gauss’s constraint. (Figure 12.8)

Our conical construction has provided a missing link, in the necessary coherence of the orbital sectors with the corresponding triangles. This, in turn, will allow us to supersede the crude approximation, used so far, and to determine the Ceres distance with a precision which Laplace and his followers considered to be impossible.

The details will be worked out in the following chapter. But, it is already clear, that we have advanced by another, critical dimension, closer to victory. The key to our success, was a sortie into the “continuous manifold” underlying the planetary orbits.

—JT

Grasping the Invisible Geometry Of Creation

In the previous chapter, we shifted our attention from the visible form of Ceres' orbit, to its *generation* in a higher domain. With the help of a simple geometrical metaphor, we represented the higher domain by a circular cone with its axis in the vertical direction, and the lower, "visible domain" by a horizontal plane. We made the plane intersect the cone at its vertex, at the location corresponding to the center of the sun, and likened the relationship of visible events to events in the higher, "conical space," to a projection from the cone, parallel to the conical axis, down to the plane.

In fact, if we trace Ceres' orbit on the horizontal plane, that form is the projected image of a conic section on the cone.

How is it possible to use the geometry of visual space, to "map" relationships in a "higher space" of an axiomatically different character? Only as paradox. Obviously, no "literal" representation is possible, nor do we have a mere analogy in mind. When we represent visual space by a *two-dimensional* plane (inside visual space!), and the higher space as a cone in "three dimensions," projected onto the plane, we do not mean to suggest that the higher space is only "higher" by virtue of its having "more dimensions." Rather, we should "read" the axis of the cone in our representation, to signify a different *type* of ordering principle than that of visual space—one embodying features of the transfinite, "anti-entropic" ordering of the Universe as a whole.

Reflecting on the irony of applying constructions of elementary geometry to such a metaphorical mapping, the following idea suggests itself: The geometry of visible space has shown itself *appropriate* to a process of discovery of the reality lying outside visual space, when it is considered not as something fixed and static, but as constantly *redefined* and *developed* by our cognitive activity, just as we develop the well-tempered system of music through Classical thorough-composition. Should we not treat elementary geometry from the standpoint, that visual space is created and "shaped" *to the purpose* of providing reason with a pathway toward grasping the "invisible geometry" of Creation itself?

Keeping these ironies in mind, let us return to the challenge which last chapter's discussion placed in front of us. We developed a method for constructing an

FIGURE 13.1. The orbital parameter is the projection of diameter l' in the circular cross-section of the cone at height h of V . Diameter l' is generated by the intersection of the circular and elliptical cross-sections.

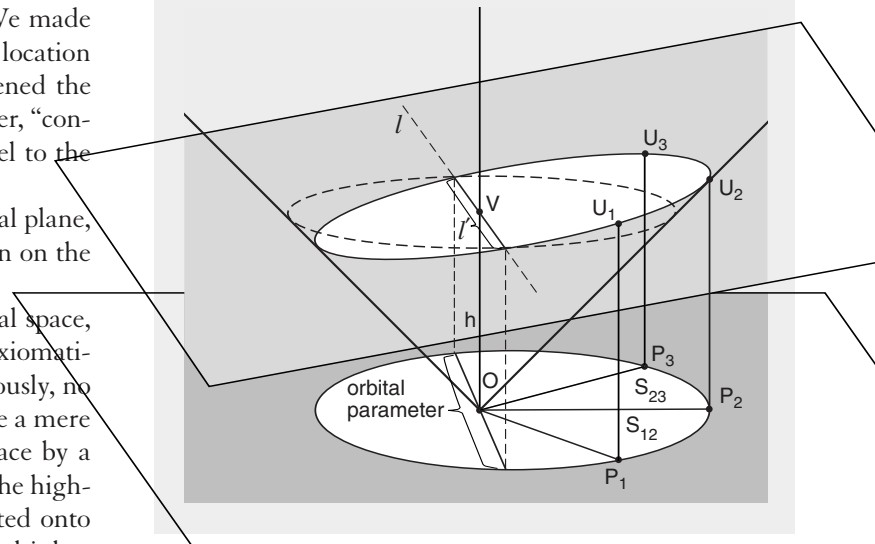

approximation of Ceres' position, which did not adequately take into account the space-time curvature in the small. As a result, we introduced a source of error which could lead to major discrepancies between our estimate of the Earth-Ceres distance, and the real distance. If Gauss had not corrected that fault, his attempt at forecasting the orbit of Ceres, would have been a failure.

We have no alternative, but to investigate the curvature in the small which characterizes the spatial relationship between any three positions P_1, P_2, P_3 of a planet, solely by virtue of the fact that they are "moments" of one and the same Keplerian orbit. And, to do that without any assumption concerning the particular form of the conic-section orbit.

We projected the three given positions up to the cone, to obtain points U_1, U_2, U_3 . The latter three points determine a *unique* plane, which intersects the cone in a conic section, and whose projection onto the horizontal plane is the visible form of Ceres' orbit. The intersection of that same plane with the axis of the cone, at a point we called V , is an important singularity. The circular cross-section of the cone at the "height" of V , is cut by the $U_1U_2U_3$

FIGURE 13.2. Relationship of height h to the orbital parameter. The diagram represents the cross-sectional “cut” of the cone, by the plane defined by the vertical axis and the segment l' (represented here as the segment between points a and b). Since the apex angle of the cone is 90° , the triangles aVO and bVO are isosceles right triangles. Consequently, $h = aV = bV = (1/2) \times (\text{length of } ab) = \text{half-parameter of orbit}$.

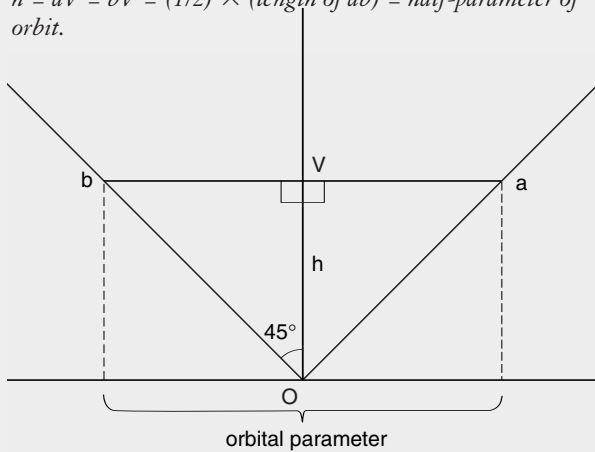

plane at two points, which are the endpoints of a diameter l' through V . That diameter projects (without change of length) to the segment which represents the width of the Ceres' orbit, measured perpendicularly to the axis of the orbit at its focus O . That length is what Gauss calls the “orbital parameter.” (Figure 13.1)

Thus, Gauss's parameter is equal to the cross-section diameter of the cone at V , which, in turn, is proportional to the height of V on the conical axis. The factor of proportionality depends upon the apex angle of the cone; that factor becomes equal to 1, if we choose the apex angle of the cone to be 90° (so that the surface of the cone makes an angle of 45° with the horizontal plane at O). Let us choose the apex angle so. In that case, the height h of V above the axis is equal to half the orbital parameter. (Figure 13.2)

Now recall, that according to Gauss's recasting of Kepler's constraints, the area swept out by the planet in any time interval, is proportional to the elapsed time, multiplied by the square root of the half-parameter. (SEE Chapter 8) Our analysis actually showed, that the constant of proportionality is π , when the elapsed time is measured in years, length in Astronomical Units (A.U.) (Earth-sun distance), and area in square A.U.

From these considerations, we can now express the areas of the orbital sectors of Ceres, in terms of the elapsed times and the height h of V on the cone. For example:

$$S_{12} = \sqrt{h} \times \pi \times (t_2 - t_1), \quad \text{and}$$

$$S_{23} = \sqrt{h} \times \pi \times (t_3 - t_2).$$

At the close of the last chapter, we remarked that the

value of h must somehow be expressible in terms of the triangular areas T_{12} , T_{23} , T_{13} ; and, that the resulting link with S_{12} and S_{23} , via h , would finally provide us with a much more “fine-tuned” approximation to the crucial ratios $T_{12}:T_{13}$ and $T_{23}:T_{13}$ than was possible on the basis of our initial, crude approach. (Figure 13.3)

Not to lose your conceptual bearings at this point, before we launch into a crucial battle, remember the following: The significance of the orbital parameter, now represented by h , lies in the fact that it embodies the relationship between

- (i) the Keplerian orbit as a whole;
- (ii) the array of “geometrical intervals” between any three positions P_1, P_2, P_3 on the orbit; and
- (iii) the curvature of each arbitrarily small “moment of action” in the planet's motion, as expressed in the corresponding orbital sector, and above all in the relationship between the “curved” sectoral area and corresponding triangular area.

Gauss focussed his attention on the sector and triangle formed between the first and the third positions, S_{13} and T_{13} . Our experimental calculations, reviewed in the last chapter, indicated that the discrepancy between these two, is the main source of error in our method for calculating the Earth-Ceres distance. Hence, Gauss looked for a way to accurately estimate that area.

Gauss noted that most of the excess of S_{13} over T_{13} , i.e., the lune-shaped area between the orbital arc from P_1 to P_3 and the segment P_1P_3 , is constituted by the triangular

FIGURE 13.3. Our conical projection, which contains both the triangular areas and the elliptical sectors as well as the orbital parameter h , will help us to devise a “fine-tuned” approximation to the crucial coefficients required to determine the orbit of Ceres (cf. Figure 13.1).

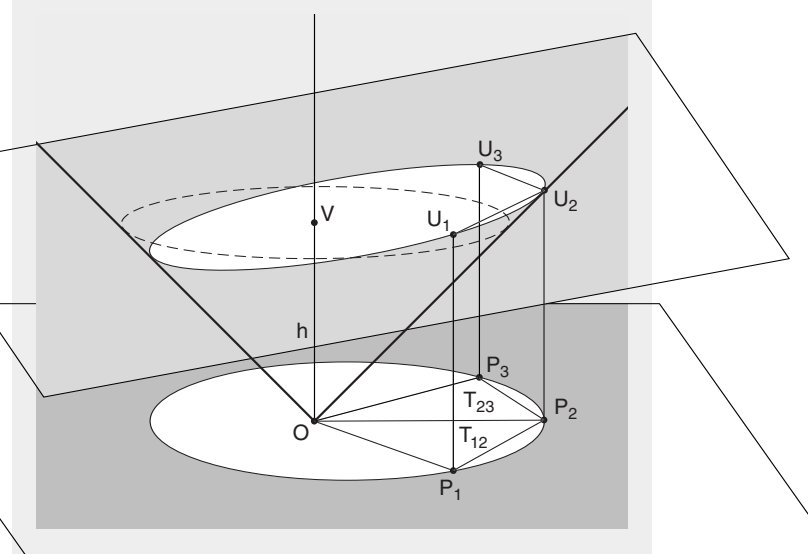
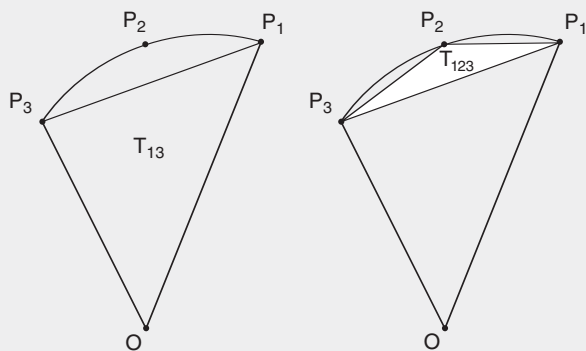

FIGURE 13.4. Most of the excess of S_{13} over T_{13} , which is the lune-shaped area, is constituted by triangle T_{123} .



area $P_1P_2P_3$. Denote this triangle—the triangle formed between all three positions of the planet—by “ T_{123} .” Gauss also observed, that T_{123} is the excess of T_{12} and T_{23} combined, minus T_{13} . (Figure 13.4)

How will our exploration of conical geometry help us to get a grip on that little “differential” T_{123} ? We voiced the expectation, earlier, that “the height h of V on the cone must somehow be expressible in terms of the triangular areas T_{12} , T_{23} , T_{13} .” The time has come, to make good on our promise.

An Elementary Proposition of Descriptive Geometry

Those brought up in the geometrical culture of Fermat, Desargues, Monge, Carnot, and Poncelet would experience no difficulty whatever at this point. But, most of us today, emerged from our education as geometrical illiterates.* With a bit of courage, however, this condition can be remedied.

Recall how we used the triangular areas T_{12} , T_{13} , and T_{23} to measure the relationship between the Ceres position P_2 and P_1, P_3 , as a combination of displacements along the axes OP_1 and OP_3 . Evidently, we touched upon a principle of geometry relevant to a much broader domain.

The nature of the relationship we are looking for now, becomes most clearly apparent, if we put Piazzzi’s observations aside for the moment, and examine, instead, the hypothetical case, where the P_1, P_2, P_3 are widely separated—say, at roughly equal angles (i.e., roughly 120° apart) around O . (Figure 13.5) In this case, we have a triangle $P_1P_2P_3$ in the horizontal plane, which contains the point O and is divided up by the radial lines OP_1, OP_2, OP_3 into the

smaller triangles T_{12} , T_{23} , and T_{31} . Above the triangle $P_1P_2P_3$, and projecting exactly onto it, we have the triangle $U_1U_2U_3$. This latter triangle “sits on stilts,” as it were, over the former. The “stilts” are the vertical line segments P_1U_1, P_2U_2 , and P_3U_3 , whose heights are h_1, h_2 , and h_3 . Point V is the place where the axis of the cone passes through triangle $U_1U_2U_3$. How does the height of V above the horizontal plane, depend on the heights h_1, h_2 , and h_3 ?

This is an easy problem for anyone cultured in synthetic geometry, rather than the stultifying, Cartesian form of textbook “analytical geometry” commonly taught in schools and universities. The approach called for here, is exactly the opposite of “Cartesian coordinates.” Don’t treat the array of positions, and the organization of space in general, as a dead, static entity. Think, instead, in *physical terms*; think in terms of change, displacement, work. For example: What would happen to the height of V , if we were to *change* the height of one of the points U_1, U_2, U_3 ?

Suppose, for example, we keep U_2 and U_3 fixed, while raising the height of U_1 by an arbitrary amount “ d ,” raising it in the vertical direction to a new position U_1' . (Figure 13.6) The new triangle $U_1'U_2U_3$ intersects the axis of the cone at a point V' , higher than V . Our immediate task is to characterize the functional relationship between the parallel vertical segments VV' and U_1U_1' .

The two triangles $U_1U_2U_3$ and $U_1'U_2U_3$ share the common side U_2U_3 , forming a wedge-like figure. Cut that figure by a vertical plane passing through the segments VV' and U_1U_1' . The intersection includes the segment U_1U_1' , and the lines through U_1 and V , and

FIGURE 13.5. How does the height h of V depend upon heights h_1, h_2, h_3 , which are in turn a function of the position of the plane through U_1, U_2, U_3 ?

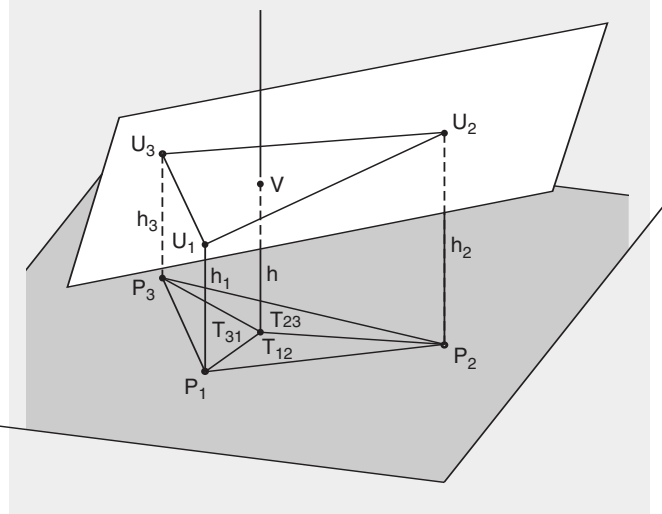

* Including the present author, incidentally.

FIGURE 13.6. Tilt the plane of the U 's up from U_1 to U_1' , to generate V' . What is the functional relationship between

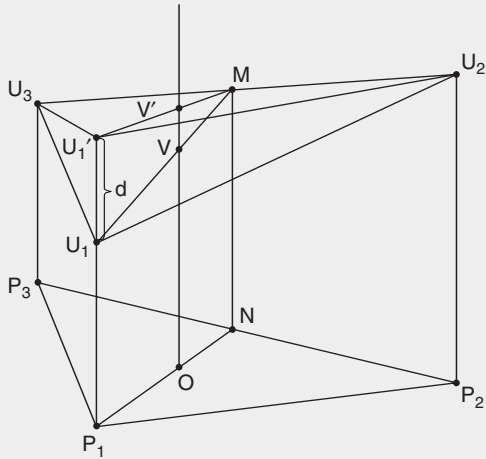

through U_1' and V' , respectively, which meet each other at some point M on the segment U_2U_3 . Two triangles are formed in the vertical plane from those vertices: U_1MU_1' , and a sub-triangle VMV' . Given that VV' is parallel to U_1U_1' , those two triangles will be similar to each other.

The ratio of similarity of these triangles, determines the relationship of immediate interest to us, namely, that between the change in height of V (i.e., the length of VV') and the change in the height of U_1 (i.e., the length of U_1U_1').

To determine the ratio of similarity of the triangles, we need only establish the proportionality between any pair of corresponding sides. So, look at the ratio $MV:MU_1$, i.e., the ratio by which V divides the segment MU_1 . *That ratio is not changed* when we project the segment onto the plane of P_1, P_2, P_3 . Under the projection, U_1 projects to P_1 , V projects to O , and M projects to some point N on the line P_2P_3 .

Our problem is reduced to determining the ratio by which O divides the line segment NP_1 —that latter being the projected image of the segment MU_1 . Very simple! Look at P_2P_3 as the base of the triangle $P_1P_2P_3$. (Figure 13.7) Draw the line parallel to P_2P_3 through P_1 . The distance separating that line and P_2P_3 is called the *altitude* of the triangle $P_1P_2P_3$, whose product with the length of the base, P_2P_3 , is equal to twice the area of the triangle T_{123} . Next, draw the parallel to P_2P_3 through the point O . The gap between that line and P_2P_3 , is the altitude of the triangle OP_2P_3 , whose product with the length of the base P_2P_3 is equal to twice the area of triangle T_{23} .

Thus, the ratio of the distances between the first and second, and the first and third—that is, of the distances

between P_2P_3 and each of the two lines parallel to it—is equivalent to the ratio of T_{23} to T_{123} . But, the ratio of distances between those parallels is “reproduced” in the proportion of the segments, formed on any line which cuts across all three. Taking in particular the line through O and P_1 (which intersects P_2P_3 at N) we conclude that

$$NO:NP_1::T_{23}:T_{123}.$$

By “inverse projection,” the same holds true for the ratio of MV and MU_1 , and by similarity, also for the ratio between VV' and U_1U_1' .

Our job is essentially finished. We have found, that when the height of U_1 is changed by any amount “ d ,” the height of V changes by an amount whose ratio to d is that of T_{23} to T_{123} . In other words, the change in height of V will be $d \times (T_{23}/T_{123})$; or, to put still another way,

$$\begin{aligned} T_{123} \times \text{change of height of } V \\ = T_{23} \times \text{change of height of } U_1. \end{aligned}$$

What happens, then, if we start off with all the heights equal to zero, and raise the heights of the vertices, one at a time, to the given heights h_1, h_2, h_3 , respectively? Raising U_1 from height zero to h_1 , will increase the height of V , from zero to $h_1 \times (T_{23}/T_{123})$. Next (by the same reasoning, applied to U_2 instead of U_1), raising U_2 to the height h_2 , will increase the height of V by an additional amount equal to $h_2 \times (T_{31}/T_{123})$.

Finally, raising U_3 to the height h_3 , will raise V by an additional amount $h_3 \times (T_{12}/T_{123})$. The final height h of V , will therefore be equal to

$$[h_1 \times (T_{23}/T_{123})] + [h_2 \times (T_{31}/T_{123})] + [h_3 \times (T_{12}/T_{123})],$$

or, in other words, $h \times T_{123}$ is equal to

$$(h_1 \times T_{23}) + (h_2 \times T_{31}) + (h_3 \times T_{12}).$$

All of this referred to the case where points P_1, P_2, P_3 are separated by such large angles, that O lies within triangle $P_1P_2P_3$ ($=T_{123}$). In the actual case before us, the

FIGURE 13.7. The division of segment NP_1 by point O is proportional to the ratio of the areas of triangles T_{23} and T_{123} .

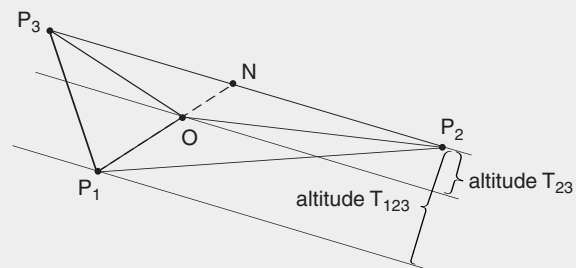

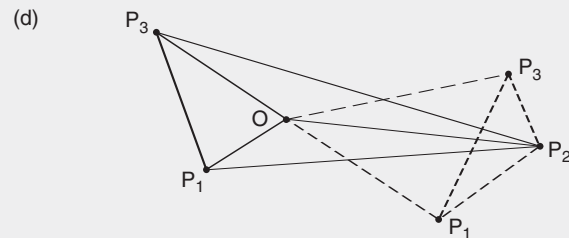
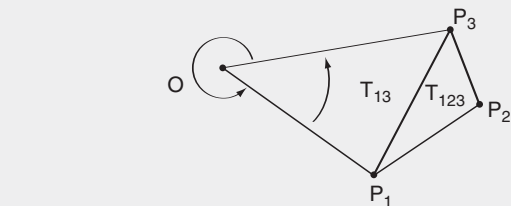
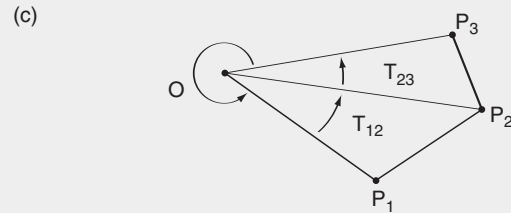
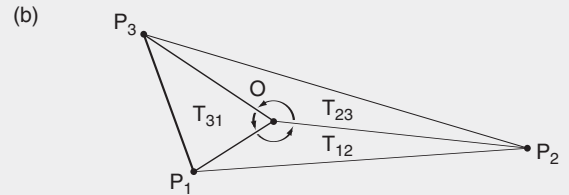
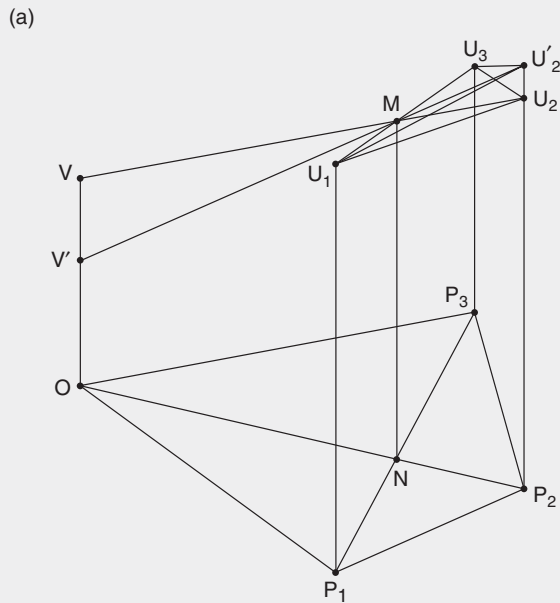

FIGURE 13.8. (a) Functional relationship of segments UU' and VV' , in the case when point O lies outside T_{123} . (b) In the earlier case, triangular area T_{31} was external to T_{12}, T_{23} . (c) Triangular areas T_{12}, T_{23}, T_{13} in the new configuration. (d) Geometrical conversion between the two cases, in the process of which the orientation of triangle T_{31} is reversed.

triangle T_{123} is very small, and O lies outside it. (Figure 13.8a) Nevertheless, it is not difficult to see—and the reader should carry this out as an exercise—that nothing essential is changed in the fabric of relationships, except for one point of elementary *analysis situs*: We were careful to observe a consistent ordering in the vertices and the triangles, corresponding to rotation around O in the direction of motion of the planet. In keeping with this, “ T_{31} ” referred to the triangle whose angle at O is the angle swept out in a *continuing rotation*, from P_3 back to P_1 . (Figure 13.8b) In our present case, where O lies outside triangle $P_1P_2P_3$ and the displacements from P_1 to P_2 and P_2 to P_3 are very small, the angle of that rotation is nearly 360° . (Figure 13.8c) In mere form, the resulting triangle OP_3P_1 is the same as OP_1P_3 , and the areas T_{31} and T_{13} both refer to the same form; however, their *orientations* are different. (Figure 13.8d)

As Gauss emphasized in his discussions of the *analysis situs* of elementary geometry, our accounting for areas must take into account the differences in orientation, so

the proper value to be ascribed to T_{31} must be the same magnitude as T_{13} , but with the *opposite sign*. In other words, $T_{31} = -T_{13}$. Examining the constructions defining the functional dependence of h on h_1, h_2 , and h_3 , for the case where the angle from P_3 to P_1 is more than 180° , we find that this *change of sign* is indeed necessary, to give the correct value for the contribution of the height of U to the height of V , namely, $h_2 \times -(T_{13}/T_{123})$. In fact, when we raise U_2 , the height of V is *reduced*. For that reason the relationship of the areas and heights, in the case of the three positions of Ceres, takes the form

$$h \times T_{123} = (h_1 \times T_{23}) - (h_2 \times T_{13}) + (h_3 \times T_{12}),$$

or,

$$T_{123} = \frac{(h_1 \times T_{23}) - (h_2 \times T_{13}) + (h_3 \times T_{12})}{h}.$$

This is a starting point for evaluating the “triangular differential” T_{123} , which measures the effect of the space-time curvature in the small.

—JT

On to the Summit

If our several-chapters' journey of rediscovery has often seemed like climbing a steep mountain, then this chapter will take us to the summit. From there, the rest of Gauss's solution will lie below us in a valley,

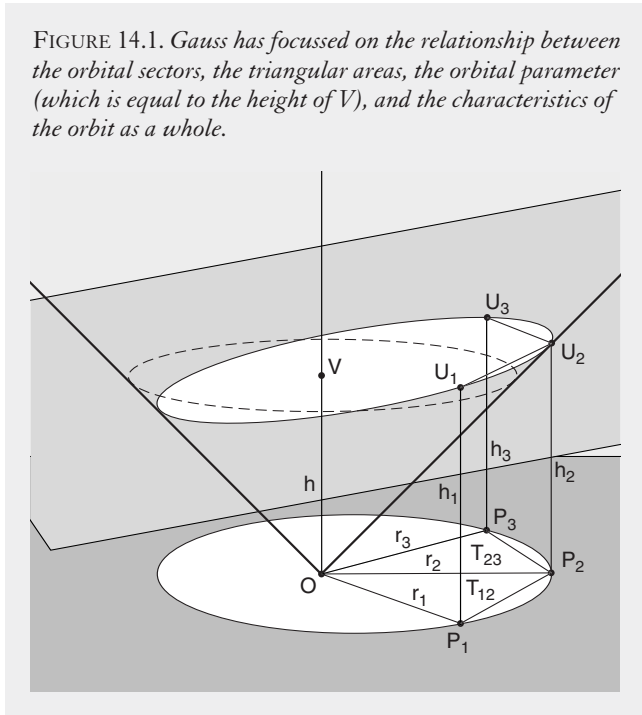

FIGURE 14.1. Gauss has focussed on the relationship between the orbital sectors, the triangular areas, the orbital parameter (which is equal to the height of V), and the characteristics of the orbit as a whole.

easily surveyed from the work we have already done.

The crux of Gauss's approach, throughout, lies in his focussing on the relationship between what we have called the "triangular differential" formed between any three positions of a planet in a Keplerian orbit, and the physical characteristics of the orbit as a whole. (Figure 14.1)

That relationship is implicit in the Gauss-Kepler constraints, and particularly in the "area law," according to which the areas swept out by the planet's motion between any two positions, are proportional to the corresponding elapsed times.

Recall our first pathway of attack on the Ceres problem. It was based on the observation, that the area of the orbital sector between any two of the three given positions, is only slightly larger than the triangular area, formed between the same two positions (and the center of the sun). On the other hand, we found that the values of those same triangular areas—or, rather, the ratios between them—determined the spatial relationship between the three Ceres positions, as expressed in terms of the "parallelogram law" of displacements. (Figure 14.2) We discovered a method for determining the positions of Ceres (or at least one of them), given the values of the triangular ratios, by applying those values to the known positions of the Earth, adding a discrepancy resulting from the difference in curvature

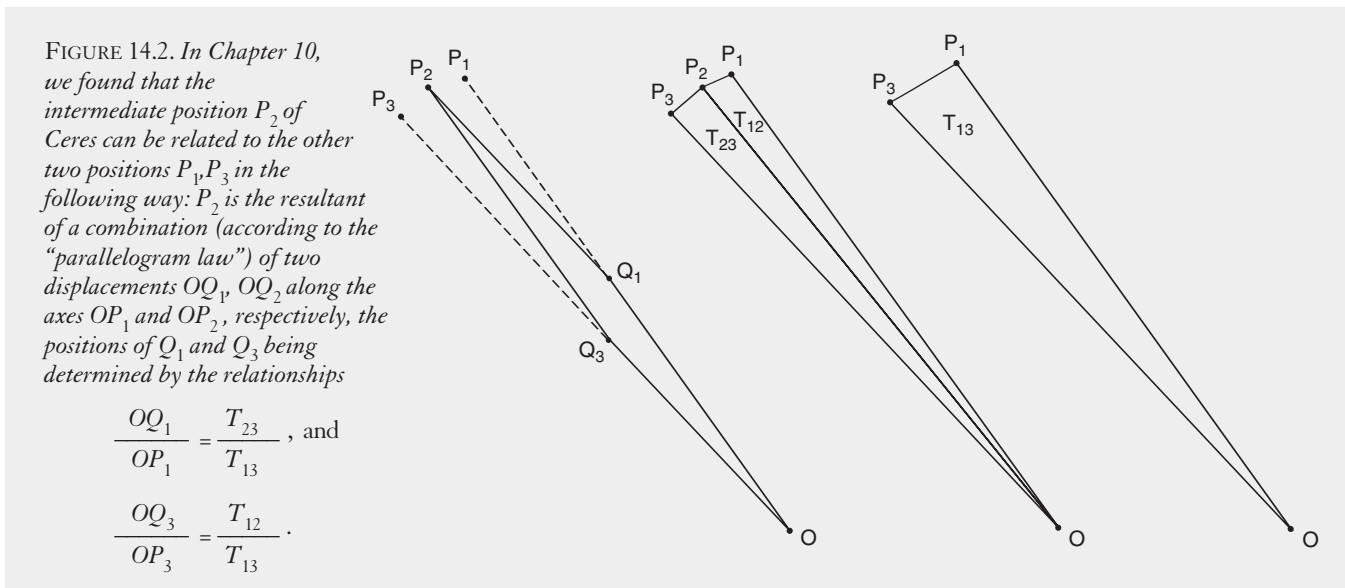

FIGURE 14.2. In Chapter 10, we found that the intermediate position P_2 of Ceres can be related to the other two positions P_1, P_3 in the following way: P_2 is the resultant of a combination (according to the "parallelogram law") of two displacements OQ_1, OQ_2 along the axes OP_1 and OP_2 , respectively, the positions of Q_1 and Q_3 being determined by the relationships

$$\frac{OQ_1}{OP_1} = \frac{T_{23}}{T_{13}}, \text{ and}$$

$$\frac{OQ_3}{OP_3} = \frac{T_{12}}{T_{13}}.$$

between the Earth and Ceres orbits, and then reconstructing Ceres' position from that discrepancy by a kind of "inverse projection." (Figure 14.3)

The obvious difficulty with our method, lay in the circumstance, that we had no *a priori* knowledge of the exact ratios of triangular areas, required to carry out the construction. At that point, we could only say that the ratios must be "fairly close" to the ratios of the corresponding orbital sectors, whose values we know to be equal to the ratios of the elapsed times according to the "area law." Our first inclination was to try to ignore the difference between the triangular and sectoral areas, and to apply the known ratios of elapsed times to obtain an approximate position for the planet. Unfortunately, a closer analysis of the effect of any given error on the outcome of the construction, showed that the slight discrepancy between triangles and sectors can produce an unacceptable final error of 20 percent, or even more (depending on the actual dimensions of Ceres' orbit). This left us with no alternative, but to look for a new principle, allowing us to estimate the magnitude of the difference between the curvilinear sectors and their triangular counterparts.

We noted, as Gauss did, that the largest discrepancy occurs in the case between the first and third positions, P_1 and P_3 , which are the farthest apart. Comparing sector S_{13} with triangle T_{13} , the difference between the two is the lune-shaped area between the orbital arc and the chord connecting P_1 and P_3 . (Figure 14.4) Most of that

area belongs to the triangle formed between P_1 , P_3 and the intermediate position P_2 , a triangle we designated T_{123} . Gauss realized, that the key to the whole Ceres problem, is to get a grip on the magnitude of that "triangular differential," which expresses the effect of the curvature of Ceres' orbit over the interval spanned by the three positions. This "local" curvature reflects, in turn, the characteristics of the entire orbit.

Given the multiple, interconnected variabilities embodied in the notion of an arbitrary conic-section orbit, we cannot expect a simple, linear pathway to the required estimate. We must be prepared to carry out a somewhat extended examination of the array of geometrical factors which combine to determine the magnitude of T_{123} . Our strategy will be to try to map the essential feature of that interconnectedness, in terms of a relationship of *angles* on a single circle.

In doing so, we are free to make use of simple special cases and numerical examples, as "navigational aids" to guide our search for a general solution.

Accordingly, look first at the simplified, hypothetical case of a circular orbit. In that case, the planet's motion is uniform; the angles swept out by the radial lines to the sun are proportional to the corresponding elapsed times, divided by the total period T of the orbit. According to Kepler's laws, $T^2 = r^3$, so T is equal to the three-halves power of the circle's radius ($r^{3/2}$).

At first glance the area T_{123} is a somewhat complicated

FIGURE 14.3. In Chapter 11, we located Ceres' position P_2 on plane Q , using a construction pivoted on the discrepancy between the curvatures of the orbits of Earth ($E_1E_2E_3$) and Ceres ($P_1P_2P_3$).

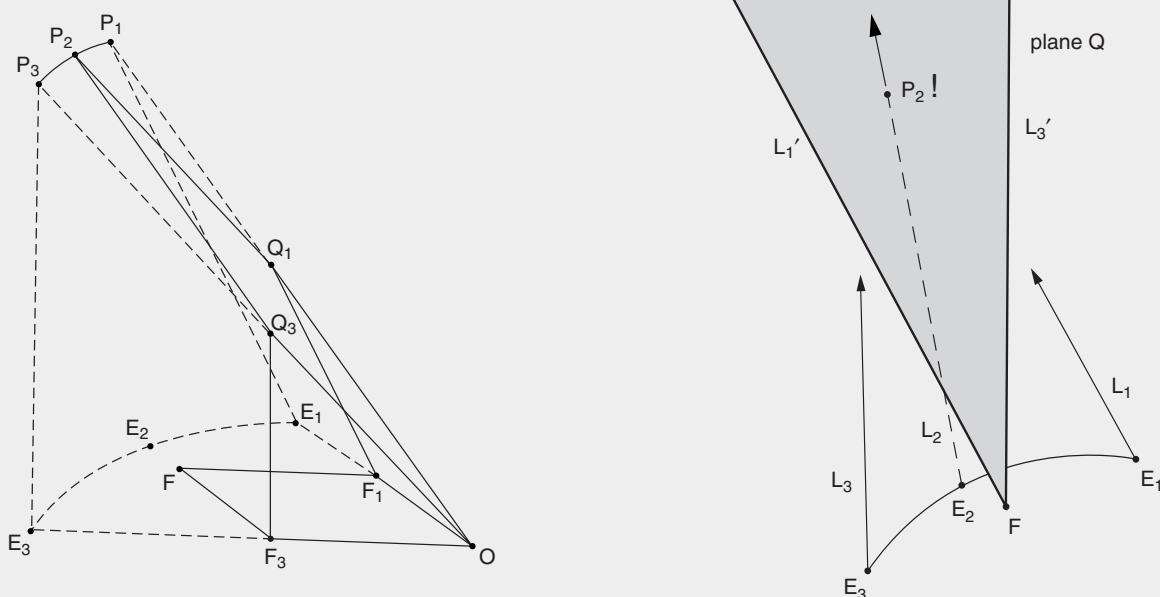

function of the angles at the sun. But there is an underlying harmonic relationship expressed in a beautiful theorem of Classical Greek geometry, which says that *the area of a triangle inscribed in a circle, is equal to the product of the sides of the triangle, divided by four times the circle's radius.* (Figure 14.5) Applying this to our case, the area T_{123} is equal to the product of the chords P_1P_2 , P_2P_3 , and P_1P_3 , divided by four times the orbital radius. (Figure 14.6)

Now, to a first approximation, when the planet's positions P_1, P_2, P_3 are not too far apart, the length of each such chord is very nearly equal to the corresponding arc on the circle. The latter, in turn, is equal in length to the total circumference of the circle, times the ratio of the elapsed time for the arc to the full period of the circular orbit [i.e., $2\pi r \times (\text{elapsed time} / r^{3/2})$]. Applying this, we can estimate T_{123} by routine calculation as follows:

$$\begin{aligned} T_{123} &\approx \frac{1}{4r} (P_1P_2 \times P_2P_3 \times P_1P_3) \\ &= \frac{1}{4r} \times \left[2\pi r \times \left(\frac{t_2-t_1}{r^{3/2}} \right) \right] \\ &\quad \times \left[2\pi r \times \left(\frac{t_3-t_2}{r^{3/2}} \right) \right] \times \left[2\pi r \times \left(\frac{t_3-t_1}{r^{3/2}} \right) \right] \\ &= 2\pi^3 \times \frac{(t_2-t_1) \times (t_3-t_2) \times (t_3-t_1)}{r^{5/2}} \end{aligned}$$

(the \approx symbol means “approximately equal to”).

What is of interest here, is not the details of the calculation, but only the general form of the result, which is to approximate T_{123} by a simple function of the elapsed times and one additional parameter (the radius). Can we

develop a similar estimate for T_{123} , without making any assumption about the specific shape of the Keplerian orbit? It is a matter of evoking the higher, relatively constant curvature, which governs the variable curvatures of non-circular orbits. Gauss had reason to be confident, that, on the basis of his method of hypergeometrical and modular functions, and guided by numerical experiments on known orbits, he could develop the required estimate—one in which the role of the radius in a circular orbit, would be played by some combination of the sun-Ceres distances for P_1, P_2, P_3 .

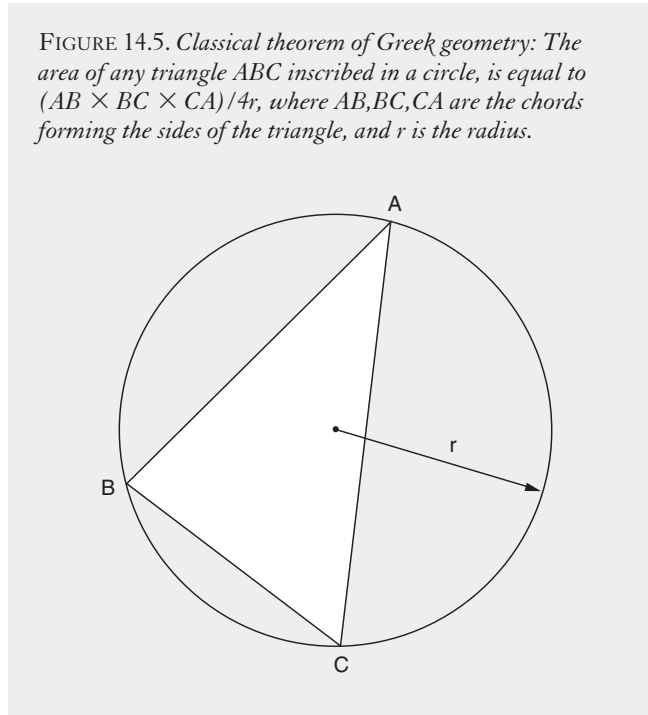

FIGURE 14.5. *Classical theorem of Greek geometry: The area of any triangle ABC inscribed in a circle, is equal to $(AB \times BC \times CA) / 4r$, where AB, BC, CA are the chords forming the sides of the triangle, and r is the radius.*

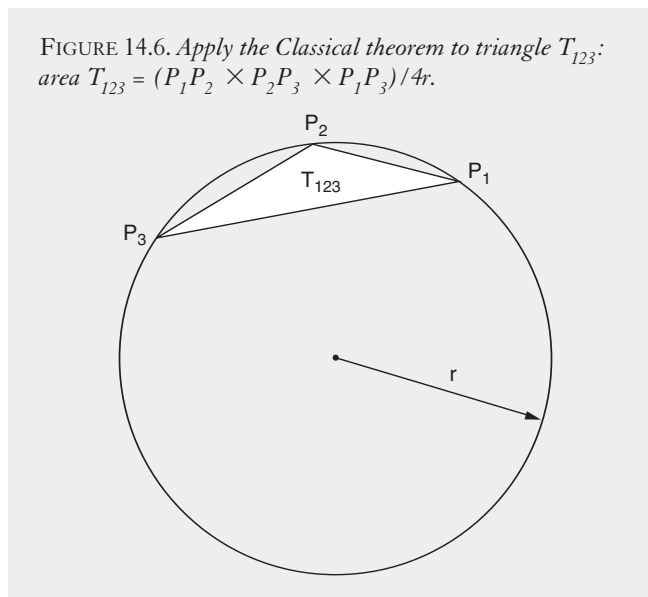

FIGURE 14.6. *Apply the Classical theorem to triangle T_{123} : area $T_{123} = (P_1P_2 \times P_2P_3 \times P_1P_3) / 4r$.*

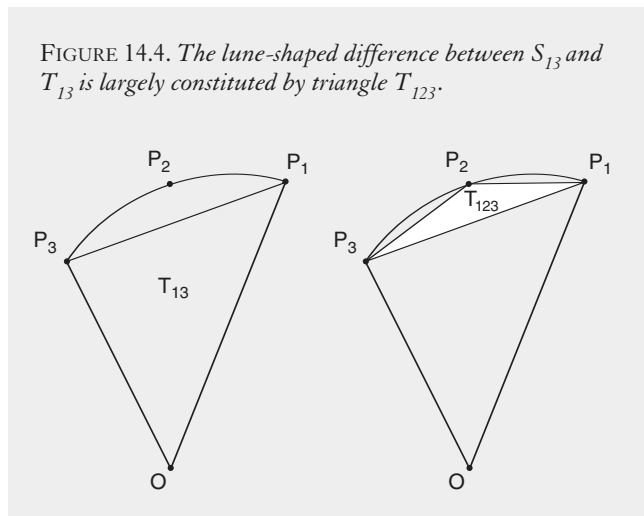

FIGURE 14.4. *The lune-shaped difference between S_{13} and T_{13} is largely constituted by triangle T_{123} .*

Nevertheless, a worrying thought occurs to us at this point: What use is a whole elaborate investigation concerning T_{123} , if the result ends up depending on an unknown, whose determination is the problem we set out to solve in the first place? The sun-Ceres distance, is no less an unknown than the Earth-Ceres distance; in fact, each can be determined from the other, by “solving” the triangle between the Earth, Ceres, and the sun, whose angle at the “Earth” vertex is known from Piazzzi’s measurements. (Figure 14.7) But, if neither of them are known, what use is the triangular relationship? And if, as it looks now, the necessary correction to our initial, crude approach to calculating the Earth-Ceres distance, turns out to depend upon a foreknowledge of that distance, then our whole strategy seems built on sand.

But, don’t throw in the towel! Perhaps, by *combining* the various relationships and estimates, and using one to correct the other in turn, we can devise a way to rapidly “close in” on the precise values, by a “self-correcting” process of successive approximations. This, indeed, is exactly what Gauss did, in a most ingenious manner.

Before getting to that, let’s dispense with the immediate task at hand: to develop an estimate for the “differential” T_{123} , independently of any *a priori* hypothesis concerning the shape of the orbit.

As already mentioned, the task in front of us involves a multitude of interconnected variabilities, which we must keep track of in some way. Although these variabilities are in reality nothing but facets of a single, organic unity, a certain amount of mathematical “bookkeeping” appears unavoidable in the following analysis, on account of the relative linearity of the medium of communication we are forced to use. Contrary to widespread prejudices, there is nothing sophisticated at all in the bookkeeping, nor does it have any content whatsoever, apart from keeping track of an array of geometrical relationships of the most elementary sort. The sophisticated aspect is implicit, “between the lines,” in the Gauss-Kepler hypergeometric ordering which shapes the entire pathway of solution.

The essential elements are already on the table, thanks to last chapter’s work on the conical geometry underlying the orbit of Ceres. Our investigation of the relationship between the triangular areas T_{12} , T_{23} , T_{13} , and T_{123} , the heights of points on the cone corresponding to P_1 , P_2 , P_3 , and Gauss’s orbital parameter h , yielded a conclusion which we summarized in the formula

$$T_{123} = \frac{(h_1 \times T_{23}) - (h_2 \times T_{13}) + (h_3 \times T_{12})}{h} \quad (1)$$

(shown in Figure 14.1).

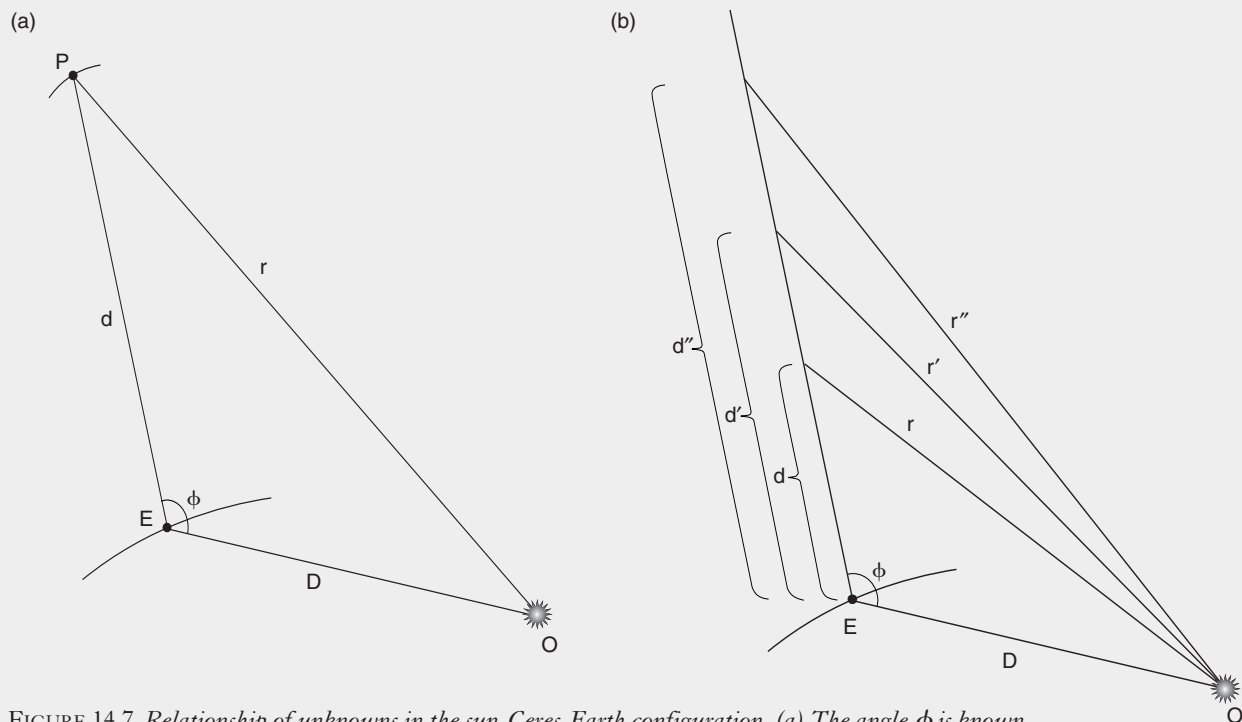

FIGURE 14.7. Relationship of unknowns in the sun-Ceres-Earth configuration. (a) The angle ϕ is known from Piazzzi’s observations, and the Earth-sun distance D is also known. This defines a functional relationship between the unknown Earth-Ceres distance d and the unknown sun-Ceres distance r , as shown in (b). (b) To each hypothetical value of r , there corresponds a unique value of d , consistent with the known values of ϕ and D .

Two immediate observations on this account: First, recall our choice of 90° for the apex angle of the cone. Under that condition, the heights h_1, h_2, h_3 will be the same as the radial distances of P_1, P_2, P_3 from the sun. We shall denote the latter r_1, r_2, r_3 .

Secondly: According to the Kepler-Gauss constraints, the *square root* of the half-parameter is proportional to the ratio of the sectoral areas swept out to the elapsed times. (SEE Chapter 8) We also determined the constant of proportionality, which amounts to multiplying the elapsed time by a factor of π . The *half-parameter itself* will then be equal to the quotient of the *product* of the areas swept out in any given *pair* of time intervals, divided by π^2 times the product of the corresponding elapsed times. So, for example, we can combine the relationships

$$\sqrt{h} = \frac{S_{12}}{(t_2 - t_1) \times \pi},$$

$$\sqrt{h} = \frac{S_{23}}{(t_3 - t_2) \times \pi}$$

(by multiplying), to get

$$h = \frac{S_{12} \times S_{23}}{(t_2 - t_1) \times (t_3 - t_2) \times \pi^2}. \quad (2)$$

This, according to **Equation (1)** above, is the magnitude by which we must divide $(r_1 \times T_{23}) - (r_2 \times T_{13}) + (r_3 \times T_{12})$, to obtain the value of the “triangular differential” T_{123} .

With that established, take a careful look at the combination of the radii r_1, r_2, r_3 and the triangular areas T_{23}, T_{13} , and T_{12} , entering into the value of T_{123} . Those triangular areas are determined by the array of vertex angles at the sun, i.e., the angles formed by the radial sides OP_1, OP_2, OP_3 , together with the values of r_1, r_2, r_3 which measure the lengths of the sides. These are all interconnected, by virtue of the fact that P_1, P_2, P_3 lie on one and the same conic section. Let us try to “crystallize out” the kernel of the relationship, by focussing on the angles and attempting to “project” the entire array in terms of relationships within a single *circle*.

There is a simple relationship between area and sides of a triangle, which can help us here. If we multiply one side of a triangle by any factor, while keeping an adjacent side and the angle between them unchanged, then the area of the triangle will be multiplied by the same factor. So, for example, if we double the length of the side B in a triangle with sides A, B, C , while keeping the length of A and the angle AB constant, then the resulting triangle of sides $A, 2B$, and some length C' , will have an area equal

FIGURE 14.8. Doubling a side of a triangle, while keeping the adjacent side and angle constant, doubles the area of the triangle.

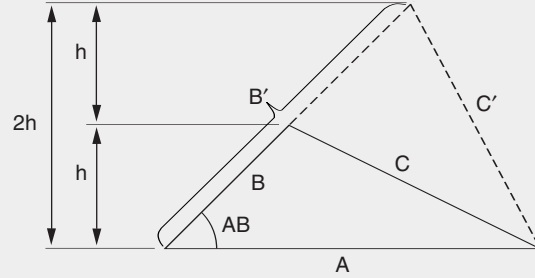

to twice that of the original triangle. (**Figure 14.8**) The reason is clear: Taking A as the base, doubling B increases the altitude of the original triangle by the same factor, while the base remains the same. Hence the area—which is equivalent to half the base times the altitude—will also be doubled. Similarly for multiplying or dividing by any other proportion.

Applying this to T_{23} , for example, notice that its longer sides are radial segments from the sun, having lengths r_2 and r_3 . (**Figure 14.9a**) If we divide the first side by r_2 and the second side by r_3 , then we get a triangular area T'_{23} , whose corresponding sides are now of unit length, and whose area is T_{23} divided by the product of r_2 and r_3 . Turning that around, the area T_{23} is equal to $r_2 \times r_3 \times T'_{23}$. The product $r_1 \times T_{23}$, which enters into our calculation of the “triangular differential,” is therefore equal to $r_1 \times r_2 \times r_3 \times T'_{23}$.

The same approach, applied to T_{13} , yields the result that

$$T_{13} = r_1 \times r_3 \times T'_{13},$$

and

$$r_2 \times T_{13} = r_1 \times r_2 \times r_3 \times T'_{13}.$$

Similarly for T_{12} . In each case, the product of all three radii is a *common factor*. Taking that common factor into account, we can now “translate” **Equation (1)** in terms of the smaller triangles, into

$$T_{123} = \frac{(r_1 \times r_2 \times r_3) \times (T'_{23} - T'_{13} + T'_{12})}{h}. \quad (3)$$

Note that the new triangles, entering into this “distilled” relationship, have the *same apex angles* at the sun, as the original triangles, but the lengths of the radial sides have all been reduced to 1. (**Figure 14.9b**)

FIGURE 14.9. “Reduction” of relationships on non-circular orbit to relationships in a circle. (a) The area of triangle T_{23}' , obtained by projecting P_2 and P_3 onto the circle of unit radius, is equal to $T_{23}'(r_2 \times r_3)$. (b) Similarly for triangles T_{12}' and T_{13}' . The original apex angles at the sun are preserved, but the lengths are all reduced to 1.

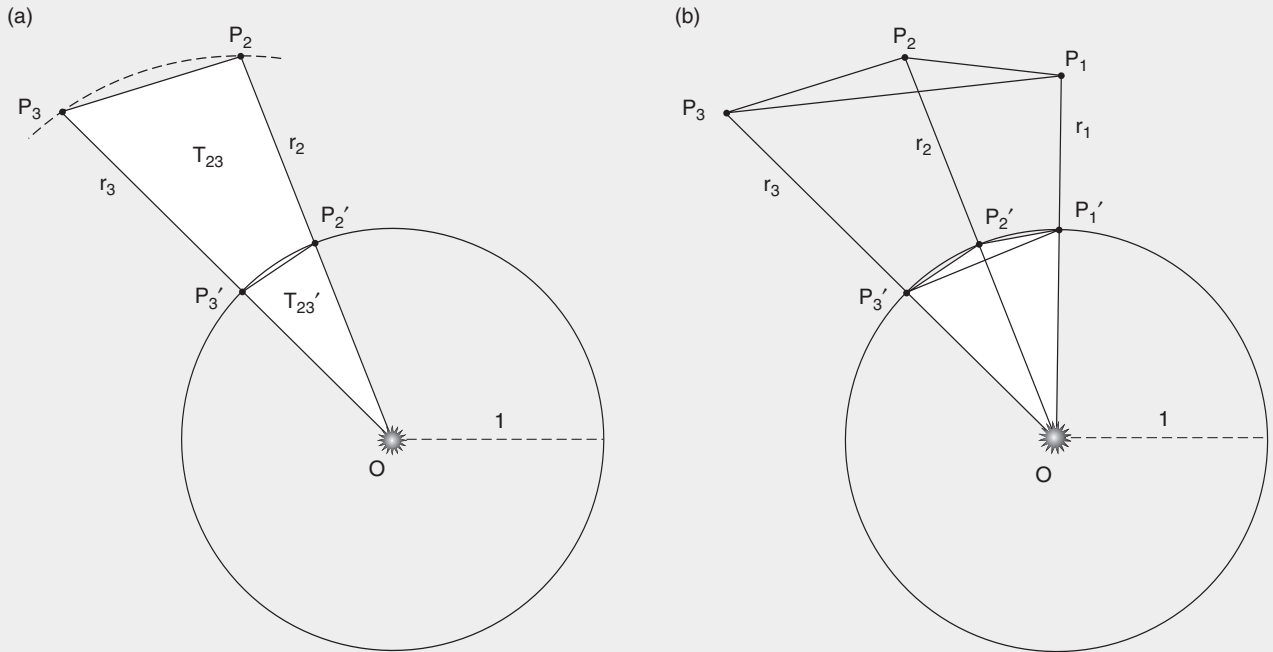

To put it in another way: We have “projected” the Ceres orbit onto the unit circle in Figure 14.9, by central projection relative to O ; the triangles T_{23}' , T_{13}' ,

T_{12}' are formed in the same way as the old ones, but using instead the points P_1' , P_2' , P_3' on the unit circle, which are the images of Ceres' positions P_1 , P_2 , P_3 under that projection. The magnitude expressed as $T_{23}' - T_{13}' + T_{12}'$, is just the triangle between P_1' , P_2' , P_3' on the unit circle. Using T_{123}' to denote that new “triangular differential” inscribed in the unit circle, our latest result is

FIGURE 14.10. Triangular area T_{123}' , inscribed in the unit circle, depends only on the angles subtended at the sun (O).

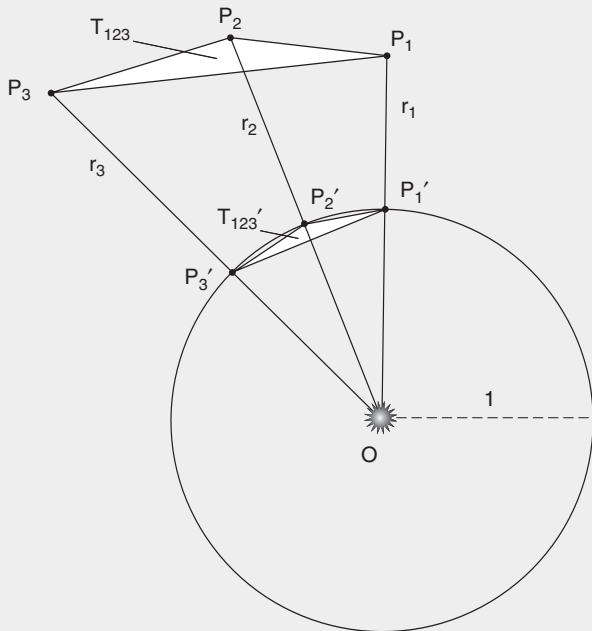

$$T_{123} = \frac{(r_1 \times r_2 \times r_3) \times T_{123}'}{h}. \quad (4)$$

Keep in mind our earlier conclusion [Equation (2)], that h is the product of the sectors S_{12} and S_{23} , divided by π^2 and the product of the elapsed times.

What we have accomplished by this analysis is, in effect, to reduce the geometry of an arbitrary conic-section orbit, to that of a simple circular orbit. Indeed, the vertices of the triangular area T_{123}' , the positions P_1' , P_2' , P_3' , all lie on the unit circle, and the area T_{123}' depends only on the *angles* subtended by Ceres' positions at the sun. (Figure 14.10)

Now, we can apply the same theorem of Classical Greek geometry, as we earlier evoked for the case of a circular orbit. The area of the triangle is equal to the product of the sides, divided by four times the radius of the circle upon which the vertices lie (in this case, the unit circle). In this case the result is

$$T_{123}' = \frac{(\text{length } P_1'P_2' \times \text{length } P_2'P_3' \times \text{length } P_3'P_1')}{4}. \quad (5)$$

So far, we have employed rigorous geometrical relationships throughout. To the extent the orbital motion of Ceres is governed by the Kepler-Gauss constraints, and to the extent the theorems of Classical Greek geometry are valid for elementary spatial relationships on the scale of our solar system, our calculation of T_{123}' and T_{123} is precisely correct.

At this point, Gauss evokes some apparently rather crude estimates for the factors which go into the product for T_{123}' . In fact, they are the same sort of crude approximations, which we attempted in our original attempt to calculate the Earth-Ceres distance. If that sort of approximation introduced an unacceptable degree of error *then*, how dare we to do the same thing, *now*?

Remember, we had determined that the “differential” T_{123} , whose magnitude we now wish to estimate, accounts for nearly all of the percentual error, which our earlier approach would have introduced into our calculation of the Earth-Ceres distance, by ignoring the discrepancy between the orbital sectors and the triangular areas. Gauss remarked, in fact, that the discrepancies corresponding to pairs of *adjacent* positions, namely between S_{12} and T_{12} and between S_{23} and T_{23} , are practically an order of magnitude smaller than the discrepancy between S_{13} and T_{13} , i.e., the one corresponding to the extreme pair of positions, which span the relatively largest arc on the orbit. (Figures 12.2 and 14.4) On the other hand, the difference between S_{13} and T_{13} , consists of T_{123} together with the small differences $S_{12}-T_{12}$ and $S_{23}-T_{23}$. As a result, T_{123} supplies the *approximate size of the “error”* in our earlier approach, up to quantities an order of magnitude smaller.

An “error” introduced in an approximate value for T_{123} , thus has the significance of a “differential of a differential.” In numerical terms, it will be at least one order of magnitude smaller—and the final result of our calculation of Ceres at least an order of magnitude more precise—than the error in our original approach, which ignored the “differential” altogether.

Also remember the following: As a geometrical magnitude, T_{123} measures the effect of curvature of the planetary orbit over the interval from P_1 to P_3 . The *relative* crudeness of the approximations we shall introduce now, concern the order of magnitude of the *change in local curvature* over that interval. But once these “second-order” approximations have served their purpose, permitting us to obtain a *tolerable first approximation* for the Earth-

Ceres distance, we shall immediately turn around, and use the *coherence* of a first-approximation Keplerian orbit, to eliminate nearly the entire error introduced thereby.

Finishing Up the Job

Turn now to the final estimation of the “differential” T_{123} . Our immediate goal is to eliminate all but the *most essential factors* entering into the function for T_{123}' , developed above, and relate everything as far as possible to the known, elapsed times.

First of all, remember that P_1', P_2', P_3' lie on the unit circle; the segments $P_2'P_1', P_3'P_2', P_3'P_1'$ are thus chords of arcs on the unit circle, at the same time form the *bases* of the rather thin isosceles triangles, with common apex at O , whose areas we have designated T_{12}', T_{23}' , and T_{13}' . (**Figure 14.11**) The altitudes of those triangles are the radial lines connecting O with the midpoints of the respective chords. Now, if the apex angles at O are relatively small, the gap between the chords and the circular arcs will be very small, and the radial lines to the midpoints of the chords will be only very slightly shorter than the radius of the circle (unity). Let us, by way of approximation, take the altitudes of the triangles to be equal to unity. In that case, the areas of the triangles will be half the lengths of their bases, or, conversely,

FIGURE 14.11. *Estimating the areas of triangles $T_{12}', T_{23}', T_{13}'$. The area of a triangle is equal to (half the base) \times (the altitude). Taking $P_1'P_2'$ as the base of triangle T_{12}' , the corresponding altitude is the length of the dashed line Oq . When P_1' and P_2' are close together, Oq will be only very slightly smaller than the radius of the circle, which is 1. Hence, the area of T_{12}' will be very nearly $(1/2) \times (P_1'P_2')$. Similarly, area $T_{23}' \approx (1/2) \times (P_2'P_3')$, and area $T_{13}' \approx (1/2) \times (P_1'P_3')$.*

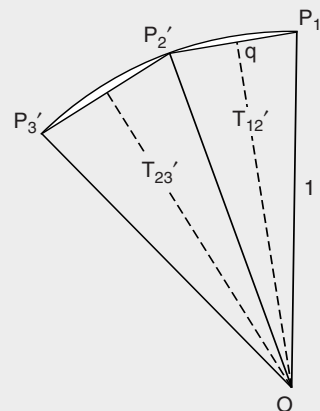

$$\begin{aligned}
P_2'P_1' &= (\text{very nearly}) 2 \times T_{12}', \\
P_3'P_2' &= (\text{very nearly}) 2 \times T_{23}', \\
P_3'P_1' &= (\text{very nearly}) 2 \times T_{13}'.
\end{aligned}$$

Applying these approximations to **Equation (5)**, we find that T_{123}' is approximately equal to

$$\frac{(2 \times T_{12}') \times (2 \times T_{23}') \times (2 \times T_{13}')}{4}, \quad (6)$$

or twice the product of T_{12}' , T_{23}' , and T_{13}' .

This is a very elegant result. But, what does it tell us about the relationship of T_{123} to T_{12} , T_{23} , and T_{13} on the original, non-circular orbit? Remember how we obtained the triangular areas entering into the above product. In numerical values, T_{12}' , T_{23}' , and T_{13}' are equal to the quotients of $T_{12}/(r_1 \times r_2)$, $T_{23}/(r_2 \times r_3)$, $T_{13}/(r_1 \times r_3)$, respectively. Expressed in terms of those original triangles, our approximate value for T_{123}' becomes

$$2 \times \frac{T_{12} \times T_{23} \times T_{13}}{(r_1 \times r_2) \times (r_2 \times r_3) \times (r_1 \times r_3)}. \quad (7)$$

Note, that each of r_1, r_2, r_3 enters into the long product exactly twice.

Finally, use this approximate value for T_{123}' , to compute T_{123} , according to relationship (4) above, noting that half of the radii factors cancel out in the process:

$$T_{123} = \frac{(r_1 \times r_2 \times r_3) \times T_{123}'}{h} \quad [\text{by Equation (4)}]$$

= [very nearly, by **Equation (7)**]

$$2 \times \frac{(T_{12} \times T_{23} \times T_{13}) / (r_1 \times r_2 \times r_3)}{h}. \quad (8)$$

A bit of bookkeeping is required, as we take into account our calculation of h , as the quotient of the product of S_{12} and S_{23} , divided by π^2 times the product of the corresponding elapsed times. [**Equation (2)**] The result of *dividing* by h , is to *multiply* by π^2 and the elapsed times, and *divide* by the product of the sectors. Assembling all these various factors together, with **Equation (8)**, our approximate value for T_{123} becomes

$$2 \times \frac{\pi^2 \times (t_2 - t_1) \times (t_3 - t_2) \times T_{12} \times T_{23} \times T_{13}}{S_{12} \times S_{23} \times r_1 \times r_2 \times r_3}. \quad (9)$$

For reasons already discussed above, we can permit ourselves simplifying approximations at this point, as follows. For a relatively short interval of motion, the sun-Ceres distance does not change “too much.” Thus, we can approximate the product $r_1 \times r_2 \times r_3$ by the cube of the second distance r_2 , i.e., by the product $r_2 \times r_2 \times r_2$, without introducing a large error *in percentual terms*. Next, observe that T_{12} and T_{23} appear in the numerator, and S_{12} and S_{23} in the denominator, of the quotient we are now estimating. If we simply *equate* the corresponding triangular and sectoral areas—whose discrepancies are practically an order of magnitude less than that between S_{13} and T_{13} —we introduce an additional, but tolerable percentual error into the value of T_{123} . Applying these considerations to **Equation (9)**, we obtain, as our final approximation, the value

FIGURE 14.12. S_{13} is (to a first order of approximation) very nearly equal to $T_{13} + T_{123}$.

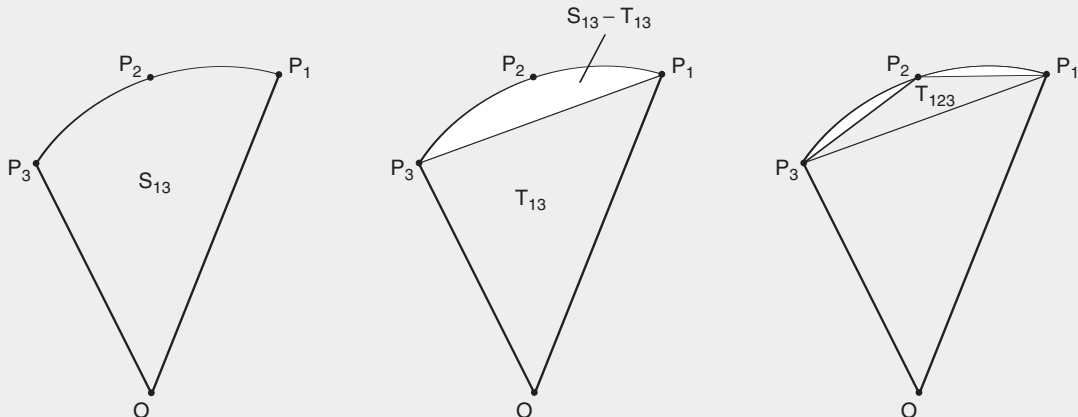

$$T_{123} \approx 2 \times \frac{\pi^2 \times (t_2 - t_1) \times (t_3 - t_2)}{r_2^3} \times T_{13}. \quad (10)$$

Recall the original motive for this investigation, which was to “get a grip” on the relationship between the sectoral area S_{13} and the triangle T_{13} . What we can say now, by way of a crucially useful approximation, is the following. Since T_{123} makes up nearly the whole difference between the triangle T_{13} and the orbital sector S_{13} (**Figure 14.12**),

$$S_{13} = (\text{to a first order of approximation}) T_{13} + T_{123},$$

or, stating this in terms of a ratio,

$$\frac{S_{13}}{T_{13}} = (\text{very nearly}) 1 + \frac{T_{123}}{T_{13}}.$$

On the other hand, we just arrived in **Equation (10)** at an approximation for T_{123} , in which T_{13} is a factor. Applying that estimate, we conclude that

$$\frac{S_{13}}{T_{13}} \approx 1 + \left(2 \times \frac{\pi^2 \times (t_2 - t_1) \times (t_3 - t_2)}{r_2^3} \right).$$

The hard work is over. We have arrived at the crucial “correction factor,” which Gauss supplied to complete his first-approximation determination of Ceres’ position. For some one hundred fifty years, following the publication of Gauss’s *Theory of the Motion of the Heavenly Bodies Moving about the Sun in Conic Sections*, astronomers around the world have used it to calculate the orbits of planets and comets. All that remains to be done, we shall accomplish in the next chapter.

—JT

CHAPTER 15

Another Battle Won

My dear friend, you have done me a great favor by your explanations and remarks concerning your method. My little doubts, objections, and worries have now been removed, and I think I have broken through to grasp the spirit of the method. Once again I must repeat, the more I become acquainted with the entire course of your analysis, the more I admire you. What great things we will have from you in the future, if only you take care of your health!

—**Letter from Wilhelm Olbers to Gauss,**

Oct. 10, 1802

We now have the essential elements, out of which Gauss elaborated his method for determining the orbit of Ceres. Up to this point, the pathway of discovery has been relatively narrow; from now on it widens, and many alternative approaches are possible. Gauss explored many of them himself, in the course of perfecting his method and cutting down on the mass of computations required to actually calculate the elements of the orbit. The final result was Gauss’s book, *Theory of the Motion of the Heavenly Bodies Moving about the Sun in Conic Sections*, which he completed in 1808, seven years after his successful forecast for Ceres. As Gauss himself remarked, the exterior form of the method had evolved so much, that it barely resembled the original. Nevertheless, the essential core remained the same.

We have tried to follow Gauss’s original pathway as much as possible. That pathway is sketched in an early manuscript entitled, *Summary Overview of the Method Used To Determine the Orbits of the Two New Planets* (the title refers to the asteroids Ceres and Pallas). The *Summary Overview* was published in 1809, but is probably close to, or even identical with, a summary that Gauss prepared for Olbers in the Fall of 1802. The latter document was the subject of several exchanges of letters back and forth between the two astronomers, where Olbers raised various questions and criticisms, and challenged Gauss to explain certain features of the method. Fortunately, that correspondence, which provides valuable insights into Gauss’s thinking on the subject, has been published. We shall quote from it in the last chapter, the *stretto*.

Our goal now is to complete Gauss’s method for constructing a first approximation to the orbit of Ceres from three observations.

In earlier discussions, we discovered a method for reconstructing the second of the three positions of the planet, P_2 , from the values of two crucial “coefficients”—namely, the ratios of triangular areas $T_{12}:T_{13}$ and $T_{23}:T_{13}$ —together with the data of the three observations and the known motion of the Earth. The difficulty with

our method lay in the circumstance, that the values of required coefficients cannot be adduced from the data in any direct way.

Our initial response was to use, instead of the triangular areas, the corresponding orbital sectors whose ratios $S_{12}:S_{13}$ and $S_{23}:S_{13}$ are known from Kepler's "area law" to be equal to the ratios of the elapsed times, $t_2-t_1:t_3-t_1$ and $t_3-t_2:t_3-t_1$. Unfortunately, the magnitude of error introduced by using such a crude approximation for the coefficients, renders the construction nearly useless. Accordingly, we spent that last three chapters working to develop a method for correcting those values, to at least an additional degree or order of magnitude of precision.

The immediate fruit of that endeavor, was an estimate for the value of the ratio $S_{13}:T_{13}$. As it turned out, S_{13} is larger than T_{13} by a factor approximately equal to

$$1 + \left(2 \times \frac{\pi^2 \times (t_2-t_1) \times (t_3-t_2)}{r_2^3} \right).$$

Let us call that magnitude, slightly larger than one, "G" (for Gauss's correction). So, $S_{13} \simeq G \times T_{13}$. What follows concerning the ratios $T_{12}:T_{13}$ and $T_{23}:T_{13}$?

We already determined, that the main source of error in replacing $T_{12}:T_{13}$ (for example) by the corresponding ratio of orbital sectors, $S_{12}:S_{13}$, comes from the discrepancy between the *denominators*. The percentage error arising from the discrepancy between the *numerators* is an order of magnitude smaller. We can now correct the discrepancy in the denominators, at least to a large extent. S_{13} being larger than T_{13} by a factor of about G , means that the *quotient* of any magnitude by T_{13} , will be larger, by that same factor, than the corresponding quotient of the same magnitude by S_{13} . In particular,

$$\frac{T_{12}}{T_{13}} \simeq G \times \frac{T_{12}}{S_{13}}.$$

If, at this point, we were to replace T_{12} by S_{12} in the numerator, we would thereby introduce an error, an order of magnitude smaller than that which we have just "corrected" using G . Granting that smaller margin of error, and carrying out the mentioned substitution, we arrive at the estimate

$$\frac{T_{12}}{T_{13}} \simeq G \times \frac{S_{12}}{S_{13}} = G \times \frac{t_2-t_1}{t_3-t_1}.$$

For similar reasons,

$$\frac{T_{23}}{T_{13}} \simeq G \times \frac{t_3-t_2}{t_3-t_1}.$$

Recall, that the ratios of the elapsed times constituted our original choice of coefficients for the construction of Ceres' position P_2 . Our new values are nothing but the same ratios of elapsed times, multiplied by Gauss's "correction factor" G . If our reasoning is valid, this simple correction should be enough to yield at least an order-of-magnitude improvement over the original values. By applying the new, corrected coefficients in our geometrical method for reconstructing the Ceres position P_2 from the three observations, we should obtain an order-of-magnitude better approximation to the actual position. *Gauss verified that this is indeed the case.*

The story is not yet over, of course. We still have the successive tasks:

- (i) To determine the other two positions of Ceres, P_1 and P_3 ;
- (ii) To calculate at least an approximate orbit for Ceres; and
- (iii) To successively correct the effect of various errors and discrepancies, until we obtain an orbit fully consistent with the observations and other boundary conditions, taking possible errors of observation into account.

We Face a Paradox

But before proceeding, haven't we forgotten something? Gauss's factor G is not a fixed, *a priori* value, but depends on the *unknown* sun-Ceres distance r_2 . We seem to face an unsolvable problem: we need r_2 to compute G , but we need G to compute the Ceres position, from which alone r_2 can be determined. **(Figure 15.1)**

As a matter of fact, *this kind of self-reflexivity is typical for Gauss's hypergeometrical domain*. Far from constituting the awesome barrier it might seem to be at first glance, the self-reflexive character of hypergeometric and related functions, is key to the extraordinary *simplification* which the *analysis situs*-based methods of Gauss, Riemann, and Cantor brought to the entire non-algebraic domain. These functions cannot be constructed "from the bottom up," but have to be handled "from the top down," in terms of the characteristic singularities of a self-reflexive, self-elaborating complex domain. A "secret" of much of Gauss's work, is how that higher domain efficiently determines all phenomena in the lower domains, including in the realm of arithmetic and visual-space geometry.

It was from this superior standpoint, that Gauss devel-

FIGURE 15.1. A self-reflexive paradox. We need r_2 to compute Gauss's "correction factor" G , but we need G to compute P_2 , from which r_2 is derived.

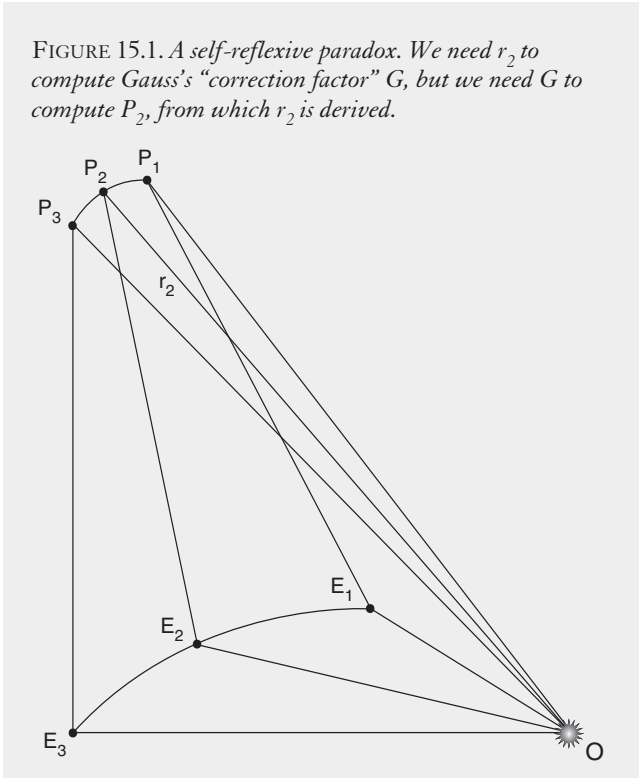

oped a variety of rapidly convergent numerical series for practical calculations in astronomy, geodesy, and other fields. Using those series, we can compute the values of hypergeometric and related functions to a high degree of precision. However, the numerical properties of the series coefficients, their rates of convergence, their interrelationships, and so on, are all dictated "from above," by the *analysis situs* of the complex domain—the same principle which is otherwise exemplified by Gauss's work on bi-quadratic residues. Although an explicit formal development of hypergeometric functions is not necessary for Gauss's original solution, the higher domain is always present "between the lines."

In the present case, Gauss's practical solution amounts to "unfolding the circle" of the reflexive relationship between r_2 and G , into a self-similar process of successive approximations to the required orbit, analogous to a Fibonacci series.

The first step, is to select a suitable initial term, as a first approximation. For the case of Ceres we might conjecture, as von Zach, Olbers, and others did at the time, that the orbit lies in a region approximately midway between the orbits of Mars and Jupiter. That means taking an r_2 close to 2.8 A.U. The corresponding value of G , computed with the help of this value and elapsed times of about 21 days between the three observations, comes out to about 1.003.

Another option, independent of any specific conjecture concerning the position of the orbit, would be to carry through our construction for P_2 without Gauss's correction, and to compute the Ceres-sun distance r_2 from the rough approximation for the Ceres position.

Having selected an initial value for r_2 , the next step is to check, whether it is consistent with the self-reflexive relationship described above. Starting from the proposed value of r_2 and the elapsed times, calculate the corrective factor G from the formula stated above; then, use that G to determine a set of "corrected" coefficients, and construct from those a new estimate for Ceres' position P_2 .

Now, compare the distance between that position and the sun, with the original value of r_2 . If the two values *coincide* to within a tolerable error, then we can regard the entire set of r_2, P_2, G , together with the associated coefficients, as consistent and coherent, and proceed to determine an orbit from them. If the two values of r_2 differ significantly, then we know the posited value of r_2 cannot be correct, and we must modify it accordingly. A mere trial-and-error approach, although feasible, is extremely laborious. Much better, is to "close in" on the required value, by successive approximations which take into account the *functional dependence* of the initial and calculated values, and in particular the *rate of change* of that dependence. By this sort of analysis, which we shall not go into here, Gauss could obtain the desired coincidence (or very near coincidence) after only a very few steps.

How To Find the Other Two Positions of Ceres

Let us move on to the next essential task. Suppose we have succeeded in obtaining a position P_2 and corresponding distance r_2 which are self-consistent with our geometrical construction process, in the sense indicated above. How can we determine the other two positions of Ceres, P_1 and P_3 ?

As we might expect, the necessary relationships are already subsumed by our original construction. Readers should review the essentials of that construction, with the help of the relevant diagrams. Recall, that P_2 was obtained as the intersection of a certain plane Q with the "line of sight" L_2 —the line running from the Earth's second position E_2 in the direction defined by the second observation. The plane Q was determined as follows. First, we constructed point F , in the plane of the Earth's orbit, according to the requirement, that F has the same relationship to the Earth's positions E_1 and E_3 , in terms of the "parallelogram law" of decomposition of displace-

ments, as P_2 has to P_1 and P_3 . (**Figure 15.2a**) For that purpose, we chose points F_1 and F_3 , located on the lines OE_1 and OE_3 , respectively, such that

$$\frac{OF_1}{OE_1} = \text{the estimated value of } \frac{T_{23}}{T_{13}},$$

and

$$\frac{OF_3}{OE_3} = \text{the estimated value of } \frac{T_{12}}{T_{13}}.$$

We then constructed the point F as the endpoint of the combination of the displacements OF_1 and OF_3 —i.e., the fourth vertex of the parallelogram whose other vertices are O , F_1 , and F_3 .

Next, we drew the parallels through F , to the other two “lines-of-sight” L_1 and L_3 . (**Figure 15.2b**) Q is the plane “spanned” by those parallels through F , and the

intersection of plane Q with L_2 is our adduced position for P_2 . We showed, that this reconstruction of the position of Ceres would actually coincide with the real one, were it not for a margin of error introduced in estimating the coefficients T_{12}/T_{13} and T_{23}/T_{13} , as well as in Piazzi’s observations themselves. We also found a way to reduce the former error, using Gauss’s correction.

Now, to find P_1 and P_3 , look more closely at the relationships in the plane Q . Call the parallels to the lines L_1 and L_3 , drawn through F , L_1' and L_3' , respectively. (**Figure 15.3**) On each of the latter lines, mark off points P_1' and P_3' , such that the distance FP_1' is equal to the Earth-Ceres distance E_1P_1 , and similarly FP_3' is equal to E_3P_3 . To put it another way: transfer the segments E_1P_1 and E_3P_3 from the base-points E_1 and E_3 , to F , without altering their directions.

What is the relationship of P_2 , to the points F , P_1' , and P_3' ? From the “hereditary” character of the entire construction, we would certainly expect the *same coefficients* to arise here, as we adduced for the relationship of P_2 to O , P_1 , and P_3 , and used in the construction of F . A bit of effort, working through the combinations of dis-

FIGURE 15.2. (a) We constructed point F using the “parallelogram law” of displacements. (b) Once constructed, plane Q at F must contain P_2 as the point of intersection with line L_2 .

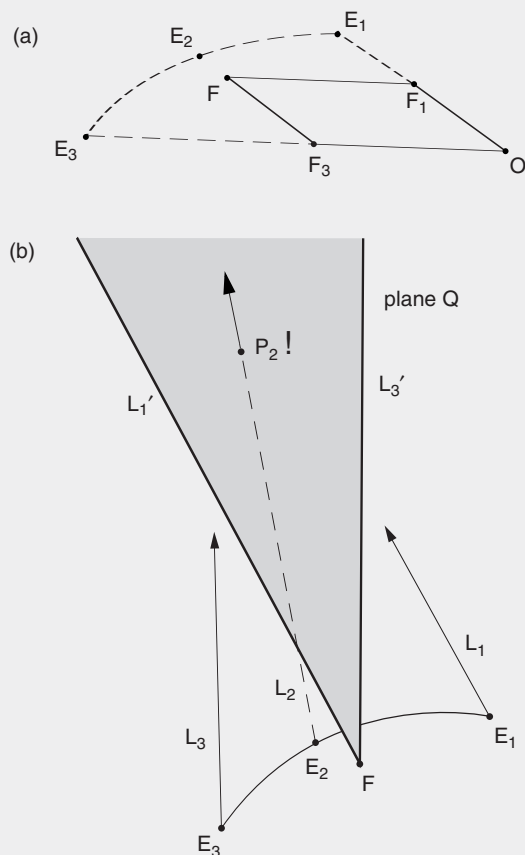
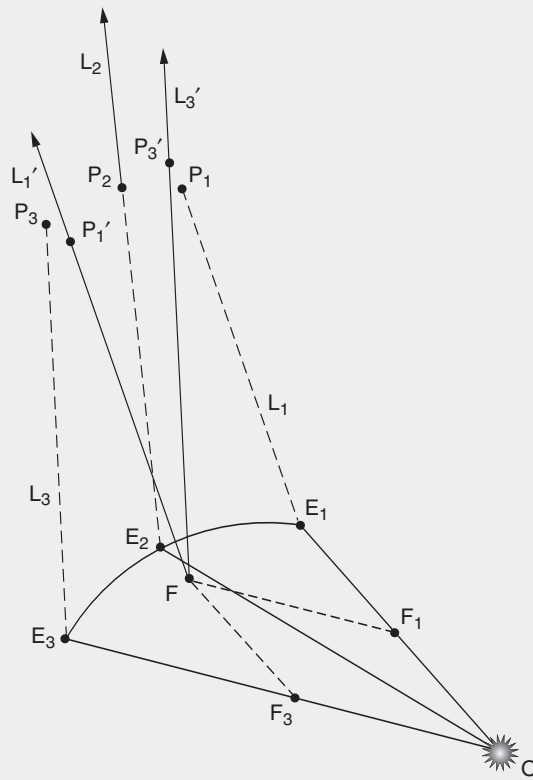

FIGURE 15.3. Having determined the position of P_2 , we now set out to locate P_1 and P_3 , by determining P_1' and P_3' in plane Q at F .



placements involved, confirms that expectation.

This leads us to a very simple construction for P_1 and P_3 . All we must do, is to decompose the displacement FP_2 —a known entity, thanks to our construction—into a combination of displacements along L_1' and L_3' . In other words, construct points Q_1' and Q_3' , along those lines, such that FP_2 is the sum of the displacements FQ_1' and FQ_3' , in the sense of the parallelogram law. (Figure 15.4) (Q_1' and Q_3' are the “projections” of P_2 onto L_1' and L_3' , respectively.) Now, P_1' and P_3' are not yet known at this point, but the “hereditary” character of the construction tells us, as we remarked above, that the values of the ratios

$$\frac{FQ_1'}{FP_1'} \quad \text{and} \quad \frac{FQ_3'}{FP_3'}$$

are the same as the coefficients used in the construction of P_2 , i.e., the estimated values of T_{23}/T_{13} and T_{12}/T_{13} . *Aha!* Using those ratios, we can now determine the distances FP_1' and FP_3' . We have only to divide FQ_1' by the first coefficient, to get FP_1' , and divide FQ_3' by the second coefficient, to get FP_3' . That finishes the job, since the lengths we wanted to determine—namely E_1P_1 and E_3P_3 —are the same as FP_1' and FP_3' respectively, by construction.

Finally, by marking off these Earth-Ceres distances along the “lines of sight” defined by Piazzzi’s observations, we construct the positions P_1 and P_3 , themselves. Another battle has been won!

—JT

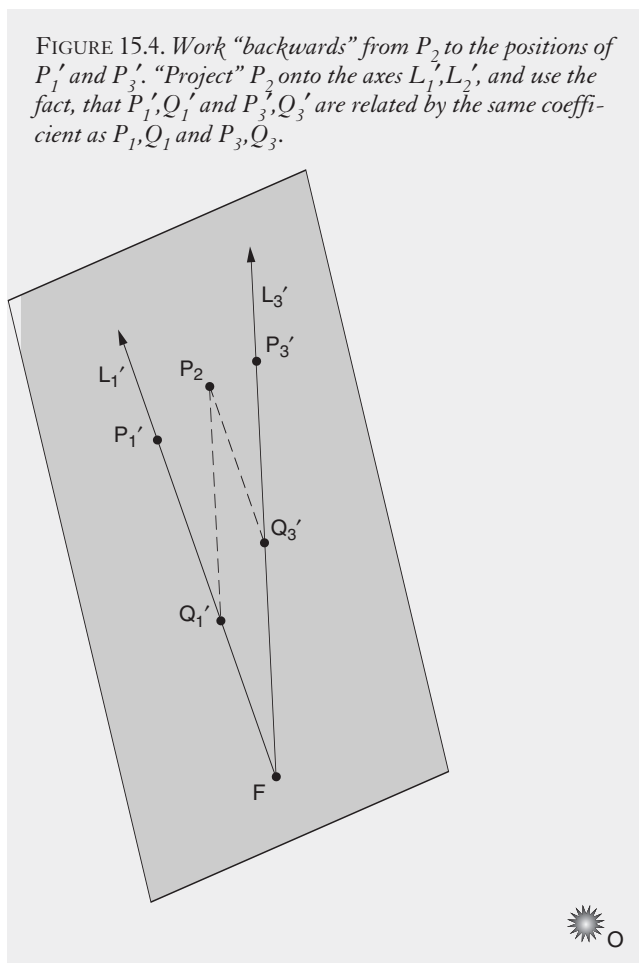

FIGURE 15.4. Work “backwards” from P_2 to the positions of P_1' and P_3' . “Project” P_2 onto the axes L_1', L_3' , and use the fact, that P_1', Q_1' and P_3', Q_3' are related by the same coefficient as P_1, Q_1 and P_3, Q_3 .

CHAPTER 16

Our Journey Comes to an End

In the last chapter, we succeeded in constructing at least to a first approximation, all three of the Ceres positions. Given the three positions P_1, P_2, P_3 what could be easier than to construct a unique conic-section orbit around the sun, passing through those positions? We can immediately determine the location of the plane of Ceres’ orbit, and its inclination relative to the ecliptic plane, by just passing a plane through the sun and any two of the positions.

To determine the shape of the conic-section orbit, apply our conical projection, taking the horizontal plane to represent the plane of Ceres’ orbit. The three points U_1, U_2, U_3 on the cone, which project P_1, P_2, P_3 , determine a unique plane passing through all three in the con-

ical space. The intersection of that plane with the cone is a conic section through U_1, U_2, U_3 ; and the projection of that curve onto the horizontal plane, is the unique conic section through P_1, P_2, P_3 , with focus at the sun. (Figure 16.1)

As simple as this latter method appears, Gauss rejected it. Why? In the case of Ceres, P_1, P_2, P_3 lie close together. Small errors in the determination of those three positions, can lead to very large errors in the inclination of the plane passing through the corresponding points U_1, U_2, U_3 on the cone. The result would be so unreliable as to be useless as the basis for forecasting the planet’s motion.

To resolve this problem, Gauss chooses a different tac-

tic. He leaves P_2 aside for the moment, and proceeds to determine the orbit from P_1 and P_3 and the elapsed time between them. Gauss developed a variety of methods for accomplishing this. The simplest pathway goes via Gauss's orbital parameter, using the "area law." Remember, the value of the half-parameter corresponds to the "height" of the point V on the axis of the cone, where the axis is intersected by the plane defining the orbit. If we know the half-parameter, then that gives us a third point V , in addition to U_1 and U_3 , with which to determine the position of the intersecting plane. Unlike P_2 , the point O lies far from P_1 , and P_3 ; the corresponding points V , U_1 , U_3 on the cone are also well-separated. As a result, the position of the plane passing through those three points is much less sensitive to errors in the determination of their positions, than in the earlier case.

How do we get the value of the half-parameter from two positions and the elapsed time between them? According to the Gauss-Kepler "area law," the area of the orbital sector between P_1 and P_3 , i.e., S_{13} , is equal to the product of (the elapsed time $t_3 - t_1$) \times (the square root of the half-parameter) \times (the constant π). The elapsed time is already known; if in addition we knew the area of the sector S_{13} , we could easily derive the value of the orbital parameter.

Another self-reflexive relationship! The exact value of S_{13} depends on the shape of the orbital arc between P_1 and P_3 ; but to know that arc, we must know the orbit. To construct the orbit, on the other hand, we need to know the orbital parameter, which in turn is a function of S_{13} .

Again, we can solve the problem using Gauss's method of successive approximations. The triangular area T_{13} , which we can compute directly from the positions P_1 and P_3 , already provides a first rough approximation to S_{13} . Better, we use $G \times T_{13}$, where G is Gauss's correction factor, calculated above. From such an estimated value for S_{13} , calculate the corresponding value of the orbital parameter. Next, apply our conical representation to constructing an orbit, using an approximation of the half-parameter, namely, the value corresponding to that estimated value of S_{13} .

Finally, with the help of Kepler's method of the "eccentric anomaly," or other suitable means, calculate the exact area of the sector S_{13} for that orbit. If this value coincides with the value we started with, our job is done. Otherwise, we must modify our initial estimate, until coincidence occurs. Gauss, who abhorred "dead mechanical calculation," developed a number of ingenious shortcuts, which drastically reduce the number of successive approximations, and the mass of computations required.

At the end of the process, we not only have the value of the orbital parameter, but also the orbit itself.

FIGURE 16.1. The elliptical orbit is easily determined from P_1, P_2, P_3 , by drawing the plane through the corresponding points U_1, U_2, U_3 (whose heights are the distances r_1, r_2, r_3 now known). However, Gauss rejected that direct method as being too prone to error when P_1, P_2, P_3 are close together.

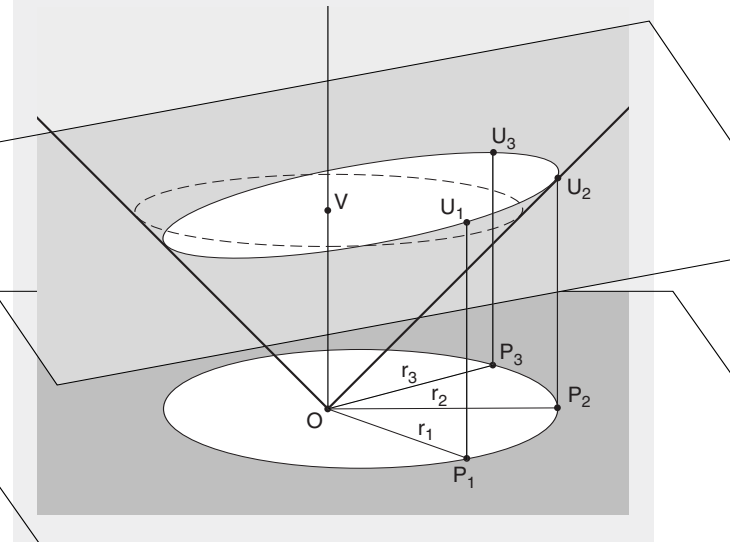

How To Perfect the Orbit

This completes, in broad essentials, Gauss's construction of a first approximation to the orbit of Ceres, using only three observations. Gauss did not base his forecast for Ceres on that first approximation, however. Remember, everything was based on our approximation to the Ceres position P_2 ; our construction of P_1 and P_3 , and the orbit itself, is only as good as P_2 .

Gauss devised an array of methods for successively improving the initially constructed orbit, up to an astonishing precision of mere minutes or even seconds of arc in his forecasts. Again, the key is the coherence and self-reflexivity of the relationships underlying the entire method.

The gist of Gauss's approach, as reported in the "Summary Overview," is as follows. How can we detect a discrepancy between the real orbit and the orbit we have constructed? By the very nature of our construction, *the first and third observations will agree precisely with the calculated orbit*: P_1 and P_3 lie on the calculated orbit as well as the lines of sight from E_1 and E_3 , and the elapsed time between them on our calculated orbit will coincide with the actual elapsed time between the first and third observations.

The situation is different for the intermediate position P_2 . If we calculate the position P_2 based on the proposed orbit—i.e., the position forecast at time t_2 —we will generally find that it disagrees by a more or less significant amount, from the " P_2 " we originally constructed. This "dissonance" tells us that the orbit is not yet correct. In

that case, we should gradually modify our estimate for P_2 , until the two positions coincide. Since P_2 must lie on the line-of-sight L_2 , the Earth-Ceres distance is the only variable involved.

Again, trial-and-error is feasible in principle, but Gauss elaborated an array of ingenious methods for successive approximation. Once he had arrived at an orbit which matched the three selected observations in a satisfactory manner, Gauss compared the orbit with the other observations of Piazzi, taking into account the vari-

ous possible sources of error. Finally, Gauss could deliver his forecast of Ceres' motion with solid confidence that the new planet would indeed be found in the orbit he specified.

Here our journey comes to an end—or nearly. For those readers who have taken the trouble to work through Gauss's solution with us, congratulations! Next chapter, we conclude with a *stretto*, on the issue of “non-linearity in the small.”

—JT

CHAPTER 17

In Lieu of a *Stretto*

In this closing discussion, we want to take on a famous bogeyman, called “college differential calculus.” Much more can and should be said on this, but the following should be useful for starters, and fun, too.

Readers may have noticed that Gauss made no use at all of “the calculus,” nor of anything else normally regarded as “advanced mathematics,” in the formal sense. Everything we did, we could express in terms of Classical synthetic geometry, the favorite language of Plato's Academy. Yet Gauss's solution for Ceres embodied something startlingly new, something far more advanced *in substance*, than any of his predecessors had developed. Laplace, famed for his vast analytical apparatus and technical virtuosity, was caught with his pants down.

Gauss's method is completely elementary, and yet highly “advanced,” at the same time. How is that possible?

Far from being a geometry of fixed axioms, such as Euclid's, Platonic synthetic geometry is a medium of metaphor—a medium akin to, and inseparable from the well-tempered system of musical composition. So, Gauss uses Classical synthetic geometry to elaborate a concept of physical geometry, which is axiomatically “anti-Euclidean.” A contradiction? Not if we read geometry in the same way we ought to listen to music: the axioms and theorems do not lie in the notes, but in the thinking process “*behind the notes*.”

Through a gross failure of our culture and educational system, it has become commonplace practice to impose upon the domain of synthetic geometry, the false, groundless assumption of *simple continuity*. It were hard to imagine any proposition, that is so massively refuted by the scientific evidence! And yet, if we probe into the minds of most people—including, if we are honest, among ourselves—we shall nearly always discover an area of fanatically irrational belief in simple continuity

and, what is essentially the same thing, linearity in the small. Here we confront a characteristic manifestation of oligarchical ideology.

Take, for example, the commonplace notion of circle, generated by “perfectly continuous” motion. Our imagination tells us that a small portion of the circle's circumference, if we were to magnify it greatly, would look more flat, or have less curvature, than any larger portion of the circumference. In other words: the smaller the arc, the smaller the net *change of direction* over that portion of the circumference.

Similarly, the standpoint of “college differential calculus” regarding any arbitrary, irregularly shaped curve, is to expect that the irregularity will decrease, and the curve will become simpler and increasingly “smooth,” as we proceed to examine smaller and smaller portions of it. This is indeed the case for the imaginary world of college calculus and analytical geometry, where curves are described by algebraic equations and the like. But what about the real world? *Is it true, that the adducible, net change in direction of a physical process over any given interval of space-time, becomes smaller and smaller, as we go from macroscopic scale lengths, down to ever smaller intervals of action?*

Well, in fact, *exactly* the opposite is true! As we pursue the investigation of any physical process into smaller and smaller scale-lengths, we invariably encounter an increasing density and frequency of abrupt changes in the direction and character of the motion associated with the process. Rather than becoming simpler in the small, the process appears ever more complicated, and its discontinuous character becomes ever more pronounced. Our Universe seems to be a very hairy creature indeed: a “discontinuum,” in which—so it appears—the part is more complex than the whole.

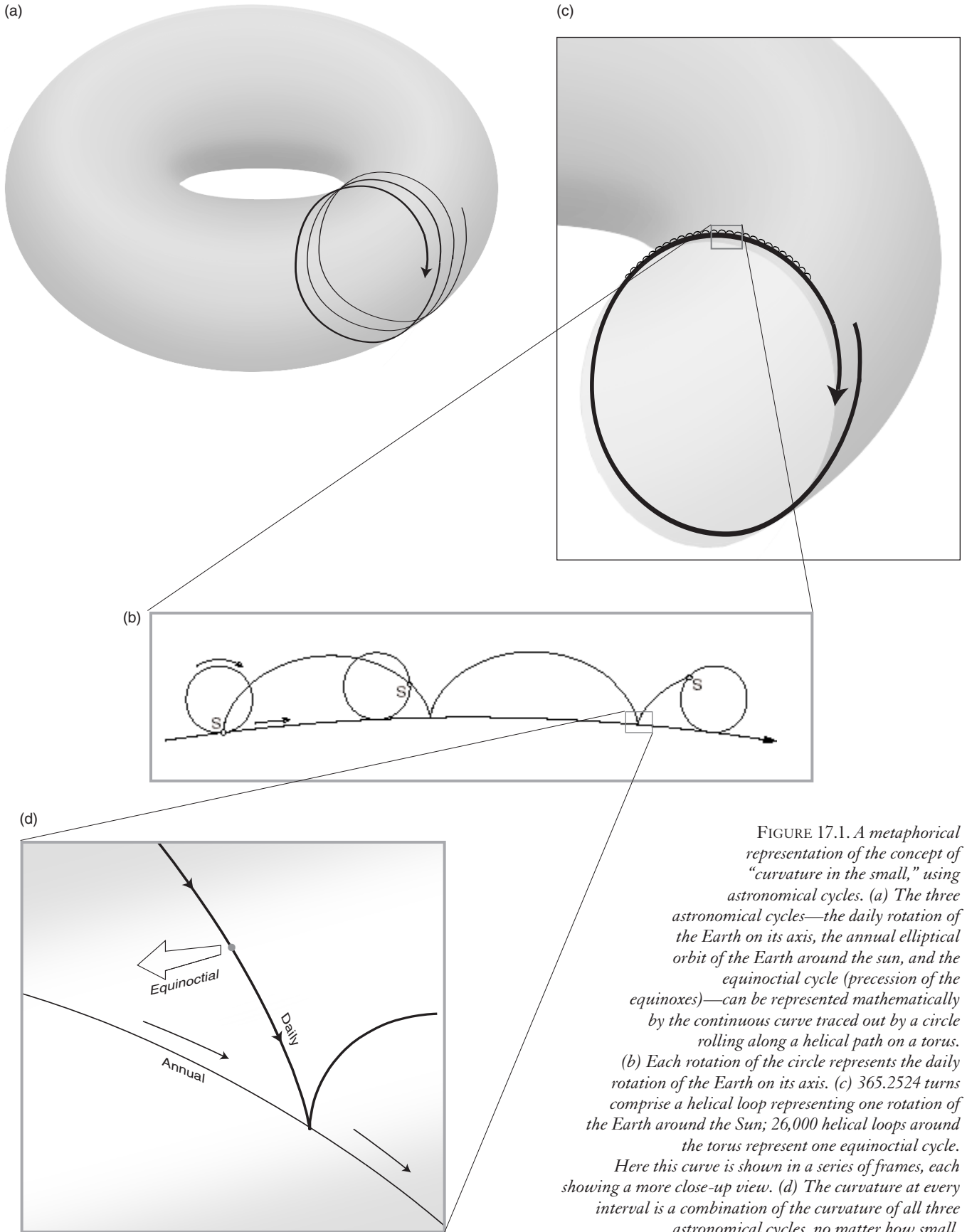

FIGURE 17.1. A metaphorical representation of the concept of “curvature in the small,” using astronomical cycles. (a) The three astronomical cycles—the daily rotation of the Earth on its axis, the annual elliptical orbit of the Earth around the sun, and the equinoctial cycle (precession of the equinoxes)—can be represented mathematically by the continuous curve traced out by a circle rolling along a helical path on a torus. (b) Each rotation of the circle represents the daily rotation of the Earth on its axis. (c) 365.2524 turns comprise a helical loop representing one rotation of the Earth around the Sun; 26,000 helical loops around the torus represent one equinoctial cycle. Here this curve is shown in a series of frames, each showing a more close-up view. (d) The curvature at every interval is a combination of the curvature of all three astronomical cycles, no matter how small.

‘Turbulence in the Small’

The existence of this discontinuum, this “turbulence in the small” of any real physical process, confronts us with several notable paradoxes and problems.

Firstly, what is the *meaning* of that “turbulence”? Why does our Universe behave that way? How does that characteristic—reflecting an increasing density of singularities in the “infinitesimally small”—cohere with the nature of human Reason? Why is a “discontinuum” of that sort, a *necessary* feature of the relationship of the human mind, as microcosm, to the Universe as a whole?

Another paradox arises, which may shed some light on the first one: When we carry our experimental study of a process down to the *microscopic level*, we find it more and more difficult to identify those features, which correspond to the *macroscopic* ordering that was the original object of our investigation.

The analogy of astronomic cycles, which we have learned something about through the course of our investigation, might help us to think about the problem in a more rigorous way. Instead of “macroscopic ordering,” let us say: a (relatively) long cycle. By the nature of the Universe, no single cycle exists in and of itself. All cycles interact, at least potentially; and the existence of any given cycle, is functionally dependent on a plenitude of shorter cycles, as well as longer cycles. Now we are asking the question: how does a given long cycle *manifest* itself on the level of much shorter cycles? At first glance, the action associated with the long cycle becomes more and more indistinct, and finally “infinitesimal,” as we descend to the length-scales characteristic of shorter and shorter cycles.

(More precisely—to anticipate a key point—we reach critical scale-lengths, below which it becomes *impossible* to follow the trace of the “long cycle” within the “short cycles,” unless we change our own axiomatic assumptions.)

We encounter this sort of thing all the time in astronomy. On the time-scale of the Earth’s daily rotation, the yearly motion of the sun appears as a very small deviation from a circular pathway. To the ancient observer, the effect of that deviation becomes evident only after many day-cycles. Similarly, recall the provocative illustration commissioned by Lyndon LaRouche, for the seemingly “infinitesimal” action of the approximately 25,700-year-long equinoctial cycle (precession of the equinoxes) within a one-second interval. (Figure 17.1)

The simplest sort of geometrical representation of such infinitesimal long-cycle action, tends to understate the problem: Suppose we did not know the existence or identity of a given long cycle. How could we uncover it

by means of measurements made only on a much smaller scale? Won’t the infinitesimally faint “signal” of the longer cycle, be hopelessly lost amidst the turbulent “noise” of the shorter cycles? Already in the case of Piazzi’s observations, the true motion of Ceres was completely distorted by the effect of the Earth’s motion. What would we do, if the cycle we were looking for were mixed together with not one, but a huge array of other cycles?

Here an unbridgeable chasm separates the method of Gauss, from that of Laplace and his latter-day followers. Just as Laplace ridiculed Gauss’s attempt to calculate the orbit of Ceres from Piazzi’s observations, calling it a waste of time, so Laplace’s successors, John Von Neumann, Norbert Wiener, and John Shannon, denied the *efficient* existence of long cycles, and sought to degrade them into mere “statistical correlations.”

The point is, we cannot solve the problem, as long as we avoid the issue of axiomatic change, and tacitly assume a simple commensurability between cycles which is tantamount to “linearity in the small.”

The Issue of Method

Let’s glance at some examples, where this issue of method arises in unavoidable fashion.

1. The paradoxes of any mechanistic theory of sound. “Standard theory,” going back to Descartes, Euler, Cauchy, *et al.*, treats air as a homogenous, “elastic medium,” within which sound propagates as longitudinal waves of alternate compression and decompression of the medium. Descartes’ “homogeneous elastic medium” is a fairy tale, of course. We know that the behavior of air depends on the existence of certain electromagnetic micro-singularities, called molecules. We can also be certain, that whatever sound *is* exactly, its propagation depends in some way on the functional activity of those molecules. At this point Boltzmann introduced the baseless assumption, only superficially different from that of Descartes and Euler, that the molecules are inert “simple bodies”—interacting only by elastic collisions in the manner of idealized tennis balls.

Experimental investigations leave little doubt, that the molecules in air are constantly in a state of a very rapid, turbulent motion at hypersonic speeds, and that events of rapid change of direction of motion take place among them, which one might broadly qualify with the term “collisions.” A single molecule will typically participate in hundreds of millions or more such events each second. On the other hand, those “colli-

sions” are anything but simple; they are vastly complicated electromagnetic processes, whose nature Boltzmann conveniently chose to ignore.

Push the resulting, simplistic picture to the limits of absurdity. Imagine observing a microscopic volume of the air, one inhabited by only a few molecules, on a time scale of billionths of a second. Where is the sound

wave? According to statistical method, the energy of the sound wave passing through any tiny portion of air is thousands, perhaps millions of times smaller than that of the turbulent “thermal” motion in a corresponding, undisturbed portion of air. What, then, is the sound wave for an individual air molecule, travelling at hypersonic speed, in the short time interval between

(a)

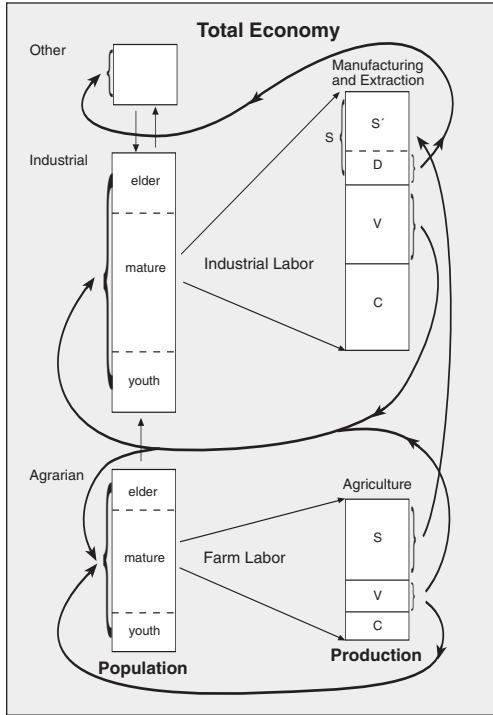

(b)

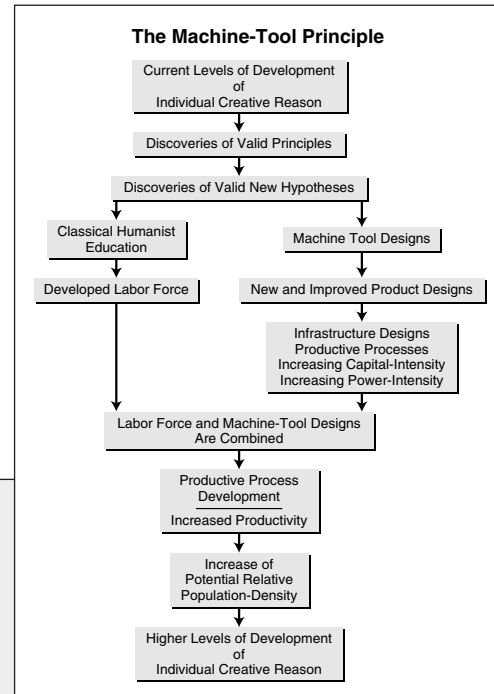

(a) Cycles of production and consumption change the internal composition of the labor force and capital. (b) Scientific discovery, technological innovation, and their assimilation into the productive economy. (c) Long-term cycle of demographic development.

(c)

FIGURE 17.2. Schematic representations used by Lyndon LaRouche to describe several crucial economic cycles. Like the astronomical cycles shown previously, these are embedded in one another, contributing simultaneously to the “action” of the productive economy at any given instant.

Growth of European Population, Population-Density, and Life-Expectancy

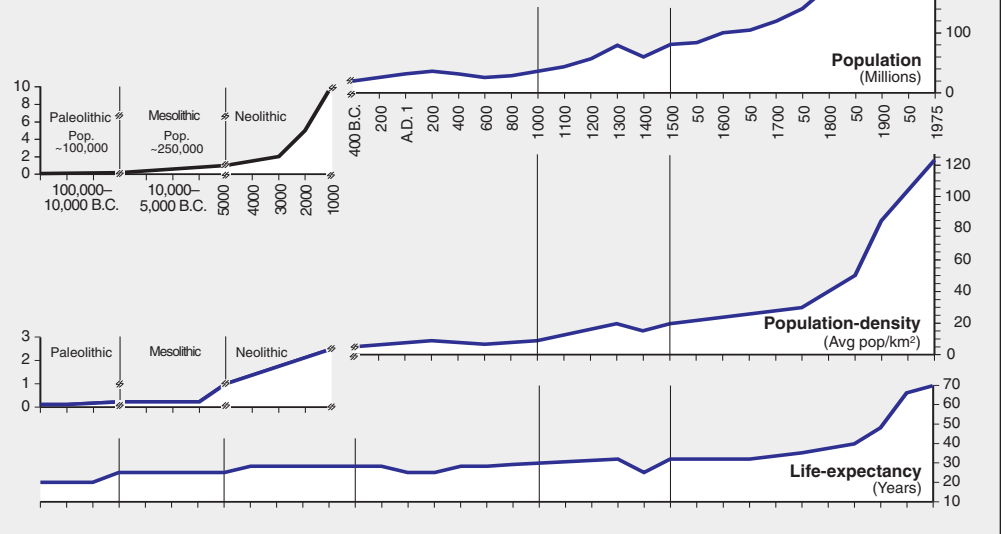

successive collisions? Does the sound wave exist at all, on that scale? According to Boltzmann, it does not: a sound wave is nothing but a statistical correlation—a mathematical ghost!

2. As implied, for example, by so-called photon effects, light is not a simple wave. Its propagation (even in a supposed “vacuum”) surely involves vast arrays of individual events on a subatomic scale. But standard quantum physics denies there is a strictly lawful relationship between the propagation of a light “wave” and the behavior of individual photons. Is “light” nothing but a statistical correlation?
3. The characteristic of living processes is self-similar conical-spiral action. But the *functional activity* of the electromagnetic singularities, upon which all known forms of life depend, is anything but simple and “smooth” in the way naive imagination would tend to misread the term, conical-spiral action. Going down to the microscopic level of intense, abrupt “pulses” of electromagnetic activity and millions of individual chemical events each second, how do we locate that which corresponds to the “long wave” characteristic, we call “living”?
4. A competent physical economist must keep track of a large array of cycles, subsumed within the overall social-reproductive cycle and the long cycle of anti-entropic growth of the *per-capita* potential population-density of the human species: demographic cycles, biological and geophysical cycles of agricultural and related production, production and consumption cycles of consumer and capital goods market-baskets, industrial and infrastructural investment/depreciation cycles interacting with the cycles of technological attrition, and so forth. (Figure 17.2) Where, within those cycles, is the causal agent of real economic growth?
5. Look at this from a slightly different standpoint: In the broad sweep of human history, we recognize a continuity of cultural development, reflected in orders-of-magnitude increases in the population potential of the human species. But that development is by definition a “discontinuum”: its very measure and focus is the individual human life, the quantum of the historical process. Nothing occurs “collectively,” as a “social phenomenon” excreted by some “*Zeitgeist*.” Nothing happens which is not the product of specific actions of individual human beings (including “non-actions”), actions bound up with the functions of the individual personality. Yet on the scale of historical “long cycles,” a human life is a short moment, with an abrupt beginning and an abrupt end. If we would take a microscope to history, so to speak, and examine the

hectic bustling and rushing around of an individual during his brief, pulse-like interval of existence, would we see the function which is responsible for the “long wave” of human development? Were it not as an “infinitesimal,” compared to the incessant hustling and bustling of existence? And yet, it is that “infinitesimal” which represents the most powerful force in the Universe!

A Well-Tempered ‘Discontinuum’

What lesson can we draw from these examples? The case of human society is the clincher: The efficient existence of the long cycle within the shorter cycles, is located uniquely in the *axiomatic characteristics of action in the small*.

Thus, the relationship between short and long cycles does not exist in the domain of naive sense-certainty; nor is it capable of literal representation in formal mathematics. To adduce axiomatic characteristics and shifts in such characteristics, is the exclusive province of human cognition! What characteristics necessarily apply to the short cycles, by virtue of their participation in the coming-into-being of a given long cycle? In this context, recognize the unique potential of the self-consciously creative individual, by deliberately changing the axioms of his or her action, to shift the entire “orbit” of history for hundreds or thousands of years to come! To command the forces of the Universe, we need not know all the details and instrumentalities of a given process; we have only to address its essential axiomatic features.

Gauss’s solution for Ceres is coherent with this point of view. His is not a simple construction, in the sense of classroom Euclidean geometry. To solve the problem, we had to focus on the significance of the fact, that there is no simple commensurability or linear-deductive relationship between

(i) the angular intervals formed by Piazzi’s observations from the Earth;

(ii) the corresponding three positions of Ceres in space;

(iii) the orbital process generating the motion of Ceres, and the “elements” of the orbit, taken as a completed entity;

(iv) the Keplerian harmonic ordering of the solar system as a whole, subsuming a multitude of astronomical cycles of incommensurable curvature.

We had to ask ourselves the question: What *harmonic relationship* must underlie the array of intervals among the observed positions of Ceres, by virtue of the fact, that those apparent positions were generated by the combined action of the Earth and Ceres (and, implicitly, the rest of the solar system)? As Kepler emphasized, it is in the harmonic, geometrical relationships—and not in nominal scalar magnitudes *per se*, whether small or large—that

the axiomatic features of physical action are reflected into visual space.

The crucial feature, emerging ever more forcefully in the course of our investigation, was expressed by the coherence and at the same time the incommensurable discrepancy, between the triangular areas of the discrete observations on the one hand, and the orbital sectors on the other. This is the same motif addressed by Gauss's

earliest work on the arithmetic-geometric mean. What shall we call it? A "well-tempered discontinuum"!

As an exercise, we invite the reader to apply the essence of Gauss's method concerning the relationship of the various levels of becoming, to the completed conception of a Classical musical composition. For, you see, there is yet another mountaintop!

—JT

APPENDIX

Harmonic Relationships In an Ellipse

(a)

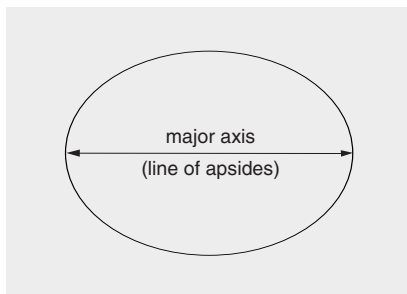

(b)

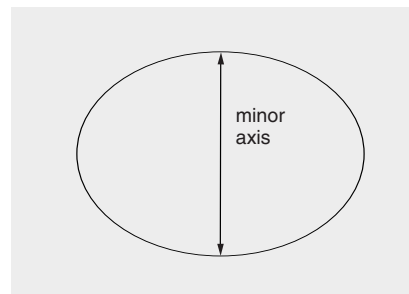

(c)

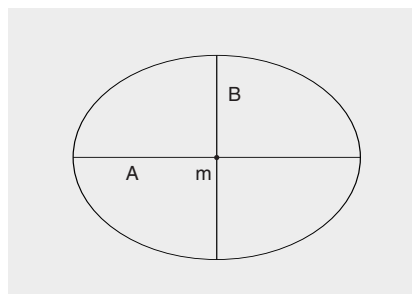

A and B are the semi-major and semi-minor axes, and m is the midpoint, or center, of the ellipse

(d)

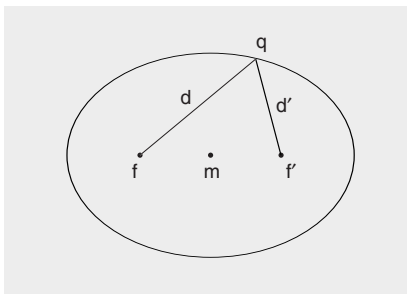

The characteristic property of the ellipse: The sum of the distance from an arbitrary point q on the perimeter, to the two foci f, f' , is a constant:

$$d + d' = \text{constant.}$$

(e)

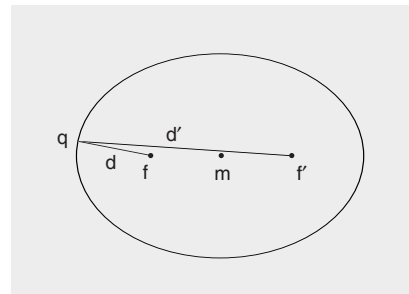

To determine the value of the sum of distances, consider the case, where q approaches the point on the major axis opposite f . At that point, we can see that the total length $d + d'$ will be equal to the major axis of the ellipse:

$$d + d' = 2A.$$

(f)

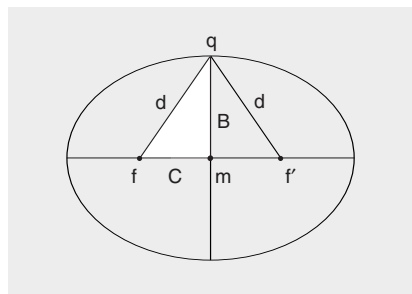

Applying the Pythagorean Theorem to the right triangle mfq , we find, that $d^2 = B^2 + C^2$. Since length d from focus f to q is equal to the semi-major axis A , and the total length $d + d = 2A$, we have the relationship between the semi-major axis A , the semi-minor axis B , and the

distance C from the focus to the midpoint m :

$$A^2 = B^2 + C^2,$$

or

$$C^2 = A^2 - B^2$$

$$C = \sqrt{A^2 - B^2}.$$

(g)

Another set of characteristic singularities: a point moving on the ellipse, reaches its maximum distance (α) from the focus f , at point a (called the “aphelion”), and its minimum distance (β) at the point p (called the “perihelion”).

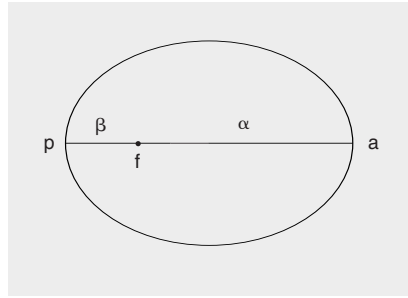

(h)

The ellipse spans the intervals between two characteristic sets of circles: the circles of radii A, B around the mid-point of the ellipse, and the circles of radii α, β around the focus f . What is the relationship between A, B and α, β ?

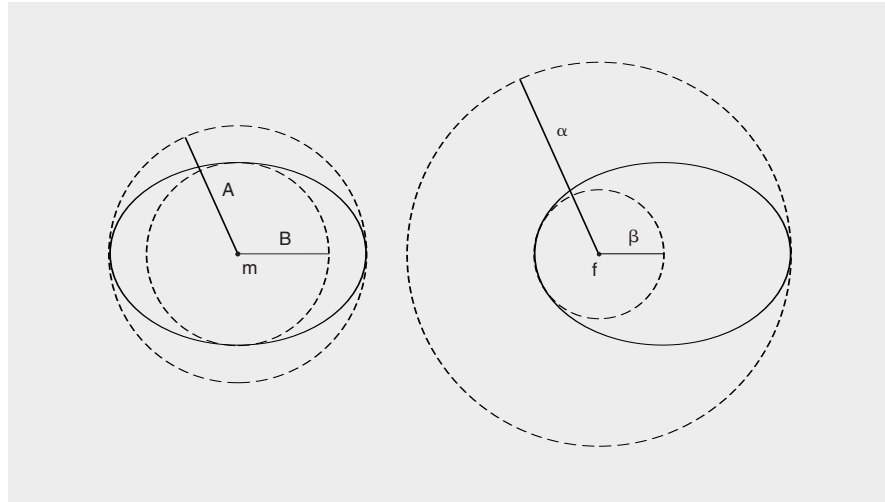

(i)

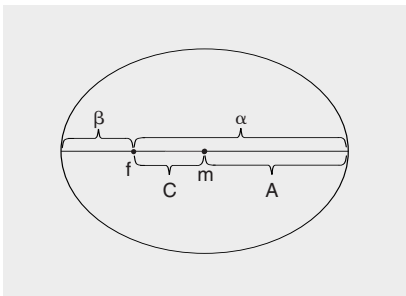

$$\begin{aligned} \alpha + \beta &= \text{major axis of ellipse} \\ &= 2A \\ A &= \frac{\alpha + \beta}{2} . \end{aligned}$$

Also, from the diagram,

$$\begin{aligned} C &= \alpha - A \\ &= \alpha - \frac{\alpha + \beta}{2} \\ &= \frac{\alpha - \beta}{2} . \end{aligned}$$

(j)

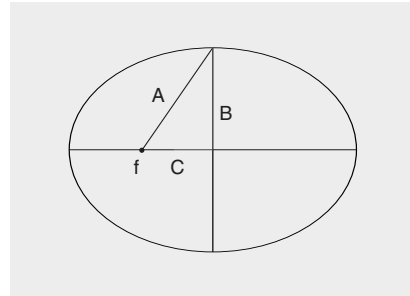

From figure (f), we have the relationship

$$A^2 = B^2 + C^2 .$$

From this, it follows that

$$\begin{aligned} B^2 &= A^2 - C^2 \\ &= \left(\frac{\alpha + \beta}{2}\right)^2 - \left(\frac{\alpha - \beta}{2}\right)^2 \\ &= \left(\frac{\alpha^2 + \beta^2 + 2\alpha\beta}{4}\right) \\ &\quad - \left(\frac{\alpha^2 + \beta^2 - 2\alpha\beta}{4}\right) \\ &= \alpha\beta ! \\ B &= \sqrt{\alpha\beta} . \end{aligned}$$

$A = (\alpha + \beta) / 2$ and $B = \sqrt{\alpha\beta}$ are known as the arithmetic and geometric means of lengths α and β . The combination of the two, inherent in the geometry of the ellipse, plays a key role in Gauss’s founding of a theory of elliptic and hypergeometric functions, based on his concept of what is called the “arithmetic-geometric mean.”

The Orbital Parameter

(k)

Still another key singularity, already presented in the text, is the “orbital parameter,” which is the length of the perpendicular qq' to the major axis at the focus f . The value Gauss most frequently works with in his calculations, is the “half-parameter” qf , corresponding to the radius in the case of a circular orbit.

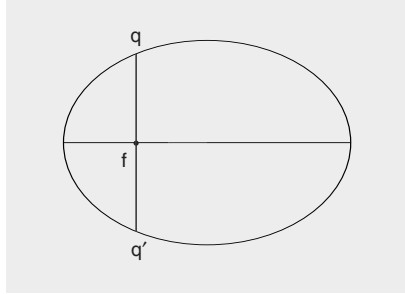

(l)

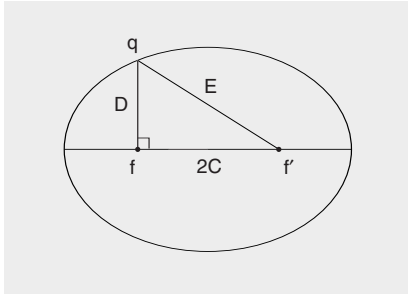

To calculate the relationship between the half-parameter (labelled “ D ”) and the semi-axes A, B , one way to proceed is as follows: From the characteristic of generation of the ellipse,

$$E + D = 2A \text{ (major axis).} \quad (\text{A1})$$

Apply the Pythagorean Theorem to the right triangle fqq' :

$$\begin{aligned} E^2 - D^2 &= (2C)^2, \text{ or} \\ E^2 - D^2 &= 4C^2. \end{aligned} \quad (\text{A2})$$

On the other hand, by factoring, we have

$$\begin{aligned} E^2 - D^2 &= (E - D)(E + D) \\ &= (E - D) \cdot 2A \end{aligned} \quad (\text{A3})$$

[by Equation (A1)].

From Equations (A2) and (A3), we have

$$E - D = \frac{4C^2}{2A} = \frac{2C^2}{A}. \quad (\text{A4})$$

Subtracting Equation (A4) from Equation (A1), we find

$$2D = 2A - \frac{2C^2}{A}$$

$$D = \frac{A^2 - C^2}{A} = \frac{B^2}{A}.$$

This result becomes much more intelligible in terms of conical projections.

Expressed in terms of the aphelion and perihelion distances, we have

$$\begin{aligned} D &= \frac{B^2}{A} = \frac{\alpha\beta}{(\alpha + \beta)/2} \\ &= \frac{2\alpha\beta}{\alpha + \beta} = \frac{2}{(1/\alpha) + (1/\beta)}. \end{aligned}$$

The latter value is known as the *harmonic mean* of α and β .

In summary, the semi-major axis, semi-minor axis, and half-parameter of an orbit, correspond to the arithmetic, geometric, and harmonic means of the aphelion and perihelion distances. These three means played a central role in the geometry, music, architecture, art, and natural science of Classical Greece

(m)

The intimate relationship to the musical system can be seen, for example, if we interpret *lengths* as signifying frequencies (or pitches), and consider the case, where $\alpha = 2\beta$ (length α corresponds to a pitch one octave higher than β). If β is “middle C,” then the pitches corresponding to the various elliptical singularities will be as labelled in the figure.

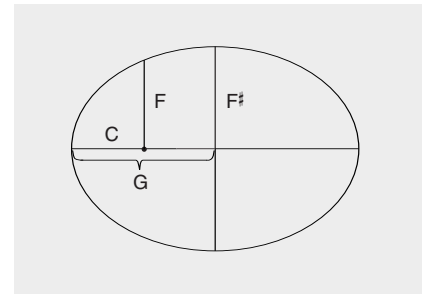

The interval $F-F^\sharp$ is the key singularity of the musical system.

The Ellipse as a Conical Projection

The underlying harmonic relationships in an ellipse become more intelligible, when we conceive the ellipse as a kind of “shadow” or projection from a higher, conical geometry. The implications of this are discussed in Chapter 12; here, we explore only the “bare bones” of the relevant geometrical construction.

(n)

Given a horizontal plane and a point f on that plane, erect a vertical axis at f and construct a vertical-axis cone having its apex at f and its apex angle equal to 90° .

Note a crucial feature of the relationship between cone and horizontal plane: for any point q in the plane, the distance d from f to q , is equal to the “height” h of the point Q lying perpendicularly above q on the cone.

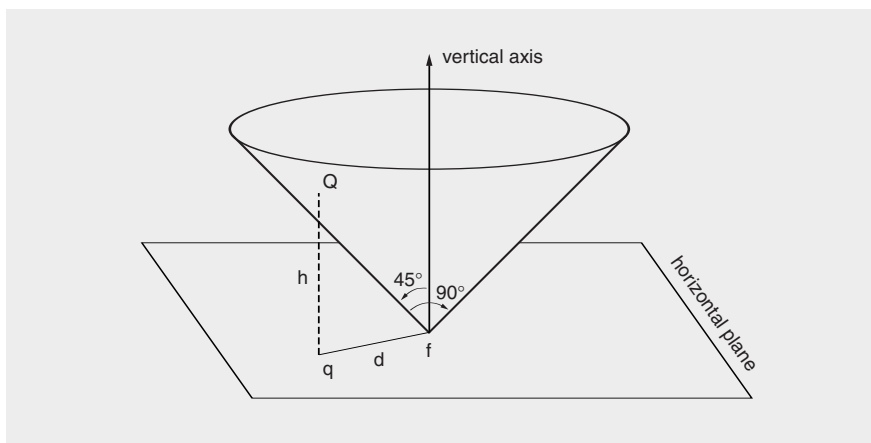

(o)

Now, cut the cone with a plane, generating a conic section. For the present discussion, consider the case, where the cutting plane makes an angle of more than 45° with the vertical axis. In this case, the conic section will be an ellipse. Now, project that curve vertically downward to the horizontal plane. The result, as we shall verify in a moment, is an ellipse having f as a focus.

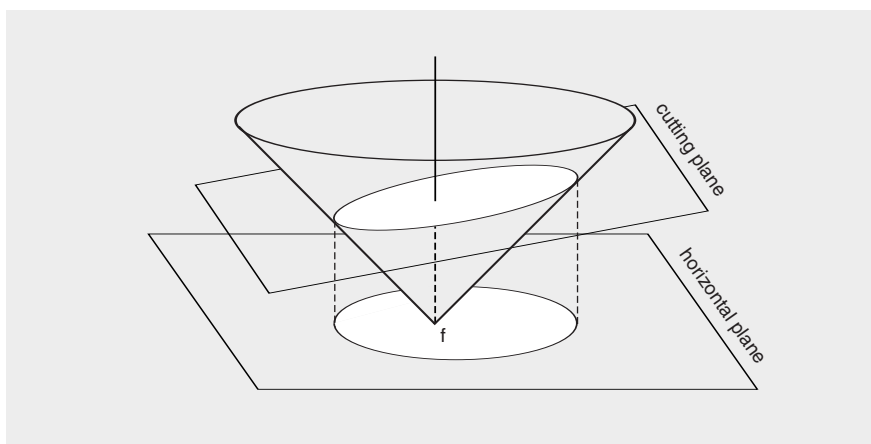

(p)

To explore the relationship so generated, examine the above figure as projected onto a plane passing through the vertical axis and the major axes of the two ellipses. (That plane makes right angles with both the cutting plane and the horizontal plane.)

With a bit of thought, we can see that the segment fV is equal to the segment D [in figure (l)], which defines the half-parameter of the projected ellipse. (Indeed, the endpoint q of the segment D on the ellipse, coincides with the position of f when the ellipse is viewed “edge-on” perpendicular to its major axis; the point Q , on the cone above q , coincides with V in the projection, and

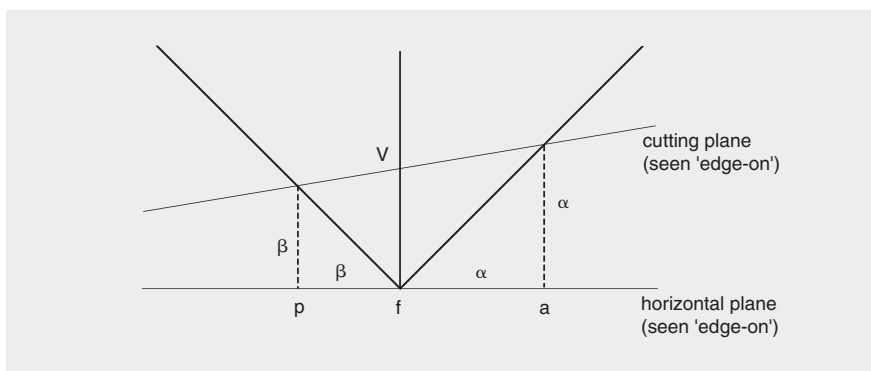

its height, which is equal to D , coincides with fV .) Those skillful in geometry can easily determine the length fV in terms of α and β from the diagram.

The result is $fV = 2\alpha\beta / (\alpha + \beta)$, confirming the expression for the half-parameter which we found by another method above in (l).

(q)

Double-conical projection. The ellipse formed by the original plane-cut of the cone, can also be realized as the intersection of that cone with a second cone, congruent to the first, but with the opposite orientation, and whose axis is a vertical line passing through the point f' lying symmetrically across the midpoint m of the projected ellipse from f .

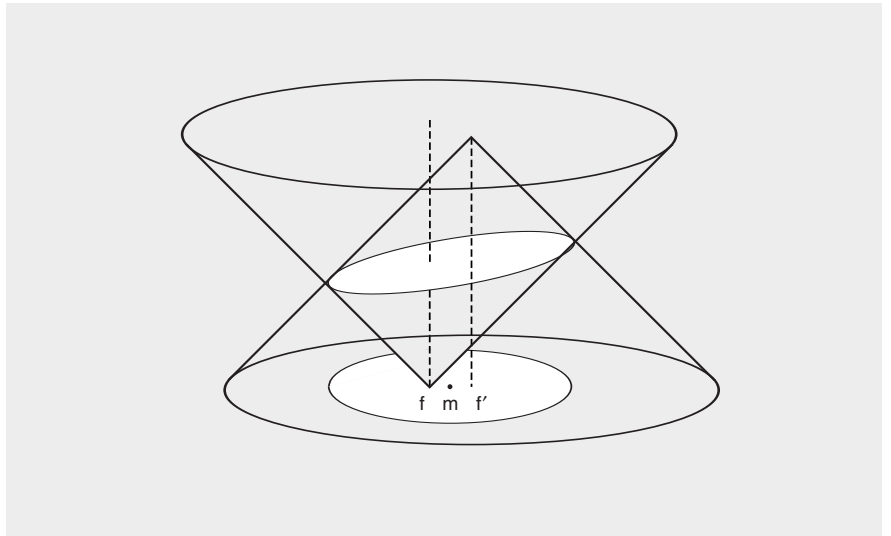

(r)

Looking at the double-conical construction in the “edge-on” view as before, we can now see why the points f, f' , corresponding to the apex-points of the cones, coincide with the foci of the ellipse. Let q represent an arbitrary point on the perimeter of the projected ellipse, let Q represent the corresponding point on the conical section. Then, by virtue of the symmetry of the construction and the relationship between “heights” and distances to the points f and f' , Qq and Qq' are equivalent, respectively, to the true distances from q to f and f' (i.e., the real distance in the plane of the projected ellipse, not those in the “edge-on” view). Since the distance between the two horizontal

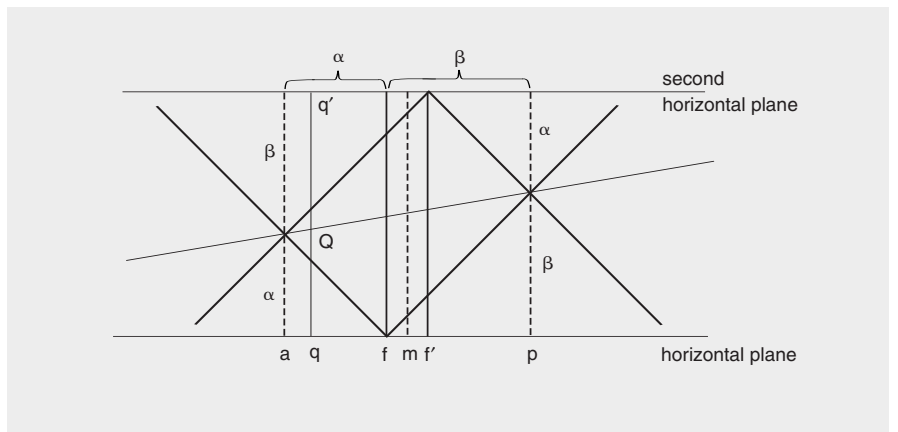

planes in the diagram is constant, $Qq + Qq'$ is constant, and therefore so is the sum of the distance qf and qf' .

—Jonathan Tennenbaum

FOR FURTHER READING

- Nicolaus of Cusa** “On the Quadrature of the Circle,” trans. by William F. Wertz, Jr., *Fidelio* (Spring 1994).*
- William Gilbert** *De Magnete (On the Magnet)*, trans. by P. Fleury Mottelay (New York: Dover Publications, 1958; reprint).*
- Johannes Kepler** *New Astronomy*, trans. by William Donahue (London: Cambridge University Press, 1992).
Epitome of Copernican Astronomy (Books 4 and 5) and *Harmonies of the World* (Book 5), trans. by Charles Glenn Wallis (Amherst: Prometheus Press, 1995; reprint).*
- The Harmony of the World*, trans. by E.J. Aiton, A.M. Duncan, and J.V. Field (Philadelphia: American Philosophical Society, 1997).*
- G.W. Leibniz** “On Copernicus and the Relativity of Motion,” “Preface to the *Dynamics*,” and “A Specimen of Dynamics,” in *G.W. Leibniz: Philosophical Essays*, trans. by Roger Ariew and Daniel Garber (Indianapolis: Hackett Publishing Company, 1985).*
- Carl F. Gauss** *Theory of the Motion of the Heavenly Bodies Moving about the Sun in Conic Sections*, trans. by Charles Henry Davis

(New York: Dover Publications, 1963; reprint).*

Bernhard Riemann “On the Hypotheses Which Lie at the Foundation of Geometry,” in *A Source Book in Mathematics*, ed. by David Eugene Smith (New York: Dover Publications, 1959; reprint).*

Lyndon H. LaRouche, Jr. The key methodological features of the works of Kepler, Leibniz, and Gauss, in opposition to the corruptions introduced by Sarpi, Galileo, Newton, and Euler, are a central theme in all the writings of Lyndon H. LaRouche, Jr. Among articles of immediate relevance to the matters presented here, are the following works which have appeared in recent issues of *Fidelio*: “The Fraud of Algebraic Causality” (Winter 1994); “Leibniz From Riemann’s Standpoint” (Fall 1996); “Behind the Notes” (Summer 1997); “Spaceless-Timeless Boundaries in Leibniz” (Fall 1997). See also LaRouche’s book-length “Cold Fusion: Challenge to U.S. Science Policy” (Schiller Institute Science Policy Memo, August 1992).*

* Starred items may be ordered from Ben Franklin Booksellers. See advertisement, page 111, for details.