



ROBERT BURNS & THE IDEAS OF THE AMERICAN REVOLUTION

AN HISTORICAL PERSPECTIVE
FOR THE DEVELOPMENT OF SCOTLAND

Mark Calney

ROBERT BURNS & THE IDEAS OF THE AMERICAN REVOLUTION

AN HISTORICAL PERSPECTIVE FOR THE DEVELOPMENT OF SCOTLAND

by Mark Calney

[Second Edition, 2007]

ACKNOWLEDGEMENTS

The chapter entitled "The Secret History of Britain's Industrial Revolution" is based on the research of Anton Chaitkin, author of *Treason in America* and co-author of *George Bush, The Unauthorized Biography*. Many of the references to Leibniz and his influence are gleaned from Philip Valenti's work, *The anti-Newtonian roots of the American Revolution* (Executive Intelligence Review, Dec. 1, 1995). Special thanks to Alan Clayton, Peter Kearney and Robert Brown of Glasgow for their help in research. Also thanks to Gabriele Chaitkin, Christine Cullinan, Neil Edmundson, and Katharine Kanter for editing; Lex Pike for his technical assistance on this second edition; and especially my wife Maureen whose efforts made this publication possible.

TABLE OF CONTENTS

| | |
|---|-----|
| Forward | 4 |
| Note on the Release of the Internet Edition | 5 |
| Preface to the Internet Edition | 7 |
| Preface to the First Edition | 8 |
| I. Robert Burns, Scotland's National Poet of Liberty | 11 |
| II. The Historic Issues of Burns' Era | 14 |
| III. The Secret History of Britain's Industrial Revolution | 25 |
| IV. Benjamin Franklin in Caledonia | 34 |
| V. The "Heaven-taught Ploughman" | 48 |
| VI. "English Gold Has Been Our Bane" | 54 |
| VII. Burns Versus Scott | 65 |
| | |
| Appendix | |
| A. Works of Robert Burns regarding the American Revolution | 76 |
| B. Robert Burns & Abraham Lincoln | 82 |
| C. A Proposal for the Economic Development of Scotland | 91 |
| D. Henry C. Carey: The American System vs. the British System | 117 |
| E. A New Bretton Woods | 120 |
| | |
| Bibliography | 123 |
| Internet Sites | 124 |

FORWARD

The thesis put forward in the present study, is that Robert Burns is, among modern poets, not only one of the very few truly original artists and teachers in a European language, but one of the most principal advocates of the ideas of Man, identified with the American Revolution of 1776.

The main novelty of this study, is that it set out to show how Robert Burns emerged from a network associated with the person of the American statesman Benjamin Franklin, and how very directly involved was Franklin himself, in the various schemes crowned with success, to build up from nothing, the infrastructure and industry of the British Isles. Far from being the jaded, irresponsible rabble-rouser and womaniser one reads about in English history books, Franklin spearheaded the last serious attempt to bring forth a politically mature population in the British Isles, by leading them to master new technologies and new branches of science.

The study is the work of an American, Mark Calney, of California. It would be wrong, therefore, for us to presume, what may be the constitutional, the political future, of those nations of Scotland, England, Wales, and the north counties of Ireland, which presently form part of the United Kingdom of Great Britain. However, we have used the term "British", to refer specifically, to matters pertaining to policies issuing from the institutions of Great Britain, as opposed to interests of Scotland, Ireland, et al. As British policy over the two centuries since the Acts of Union of 1707 and 1800, has been almost without exception, dominated by the rentier-finance interests of the House of Windsor and her allies among the more ancient noble families both on the islands, and broad, the term "British" as used here, is not only historically precise, it is also not necessarily flattering.

This 2007 edition includes expanded material on the historic role of Gottfried Wilhelm Leibniz, Sir Walter Scott versus America, and a special section on *Robert Burns & Abraham Lincoln*. The economic programme section has also been updated and includes the New Bretton Woods proposal.

NOTE ON THE RELEASE OF THE INTERNET EDITION 2007 “HISTORY’S GOLDEN OPPORTUNITY”

When President Franklin D. Roosevelt met with British Prime Minister Winston Churchill off the coast of Newfoundland aboard the USS *Augusta* in 1941 to discuss America’s conditions of entry into World War II, including post-war policies, he made it crystal clear to the PM that America was not going to be involved in order to maintain or reestablish the British or any other empire. Elliot Roosevelt, the President’s son and aide, recorded the exchange:

FDR: “I am firmly of the belief that if we are to arrive at a stable peace it must involve the development of backward countries. Backward peoples. How can this be done? It can’t be done, obviously, by eighteenth-century methods. Now –“

Churchill: “Who’s talking eighteenth-century methods?”

FDR: “Whichever of your ministers recommends a policy which takes wealth in raw materials out of a colonial country, but which returns nothing to the people of that country in consideration. *Twentieth*-century methods involve bringing industry to these colonies. *Twentieth*-century methods include increasing the wealth of a people by increasing their standard of living, by educating them, by bringing them sanitation – by making sure that they get a return for the raw wealth of their community.”

Around the room, all of us were leaning forward attentively. Hopkins was grinning. Commander Thompson, Churchill’s aide, was looking glum and alarmed. The P.M. himself was beginning to look apoplectic.

Churchill: “You mentioned India,” he growled.

FDR: “Yes. I can’t believe that we can fight a war against fascist slavery, and at the same time not work to free people all over the world from a backward colonial policy.”¹

President Roosevelt reiterated this American policy again to Churchill during their 1943 meeting in Casablanca. Unless colonialism, with its poverty and inhumanity, was eradicated in the post-war period we would only be planting the seeds for the next war:

“I’m talking about another war, Elliot,” Father cried, his voice suddenly sharp. I’m talking about what will happen to our world, if after *this* war we allow millions of people to slide back into the same semi-slavery!” . . .

“Don’t think for a moment, Elliot, that Americans would be dying in the Pacific tonight, if it hadn’t been for the shortsighted greed of the French and the British and the Dutch. Shall we allow them to do it all, all over again? *Your* son will be about the right age, fifteen of twenty years from now.”²

¹ Elliot Roosevelt, *As He Saw It*, Duel, Sloan and Pearce, New York, 1946; pp. 36-37.

² *Ibid*, p. 115; emphasis in the original.

The International Monetary Fund and World Bank were established with the guidance of FDR at the 1944 Bretton Woods Conference in New Hampshire. They were created to facilitate post-war reconstruction and the development of what would be the former colonial countries of the world through the kind of 'Great Projects' that FDR had envisioned for Africa and Asia. Upon the immediate news of the death of President Franklin Roosevelt, the Anglo-American financial and political establishment began to systematically take down all of FDR's policies nationally and internationally. With the assassination of President John F. Kennedy, who tried to revive the ideas of FDR, the world has increasingly moved towards the next world war that FDR had warned us about.

The IMF and World Bank became the administrators of a new colonialism, spreading poverty and mass murder. "Globalisation" is nothing more than modern slavery.

Now, history has given us the golden opportunity in the immediate weeks and months ahead to fulfill the dream that Franklin Roosevelt had for humanity following World War II. We are now in the midst of a global financial collapse. The moment of truth is upon us. Do we allow the speculators and assorted financial pirates to maintain their illegal power over the world, including the British/Cheney operational plans to start bombing Iran, and have the world plunged into a new Hundred Years War and Dark Age? Or, do we implement the tried and proven policies of what President Roosevelt did, beginning in 1933, to protect the population?

Though much of what must be done immediately falls on the American population to shift the present policies of the Cheney/Bush Administration, citizens of world must also act. Lyndon LaRouche, the American statesman and economist, has not only accurately warned of the present international financial collapse but has provided the necessary leadership in putting forward the positive alternatives to the crisis. A New Bretton Woods conference must be convened as soon as possible to establish a new, just economic system for the world. The roles of the U.S., Russia, China, and India are indispensable in leading this process.

In the United States, Mr. LaRouche has put before local and federal elected representatives his [*Homeowners and Bank Protection Act of 2007*](#), to implement the same kind of FDR policy to halt foreclosures on millions of people's homes while taking action to put the financial sharks of the hedge funds through a well deserved bankruptcy proceeding.

I have reissued this book in internet form in order to facilitate the increased discussions that are taking place internationally by sane people on how to build our way out of the economic crisis. Like FDR, there is presently talk and action on building the 'Great Projects' humanity needs, such as the Bering Straits tunnel connecting Russia to America and the Eurasian Land-Bridge for high speed/maglev railways. It is through these means, I believe, we can begin to remedy what Rabbin Burns called "Man's inhumanity to Man."

Mark Calney
Altadena, California September 12, 2007

PREFACE TO THE INTERNET EDITION

Alan Clayton
Argyll, Scotland September 2007

It is twelve years since I wrote the Preface for the first edition of Mark Calney's book. Not a long time by any criteria. It is a previous century indeed, but in some ways it seems like a previous age. We approached the 21st century not without some feelings of optimism. Could we really be seeing an end to interminable wars?

The optimism was to a large extent sadly misplaced. There was the brutal US/UK aggression against Iraq and the destabilisation of the Middle East that it has brought. Then, of course, there was the catastrophe of 9/11. Even here in Scotland we have not been immune from terrorism, although we always thought we were. The assault on Glasgow airport brought an end to that illusion.

Mark Calney is one of those in the Democratic Party of the United States who works endlessly and tirelessly for peace through development. That was one of the mission statements of the first edition of his book. The north of Ireland was still a very troubled land in 1995 and it was felt that the sheer volume of economic and social activity required to complete a tunnel between Scotland and Ireland would go a long way to creating the kind of hope and optimism that would break down barriers of bias and misunderstanding.

Scotland and the north of Ireland have both moved on since then as well. Here in Scotland, our parliament has been restored for the first time in 300 years. It has limited powers as yet, but few doubt that Scotland will return to the community of nations in the United Nations. In the north of Ireland mortal enemies have joined together in government.

I am glad Mark Calney has decided to reintroduce his book in an Internet edition at this time. This has been inspired by The Centre for Cross Border Studies putting forward similar proposals for a tunnel or a bridge. This proposal, which is somewhat different from Mark Calney's proposals, would see trains originating in Dublin traveling through Belfast across to Stranraer and then to Glasgow before heading down through Britain and across the English channel. Track upgrades would mean trains would be able to reach speeds of almost 200 mph, or indeed be constructed on the Maglev principle, for which Mark Calney has campaigned for so long. In a document, the CCBS outlined the pros and cons of the link, which it believes could be in place by 2030.

This book is being republished just after the Schiller Institute conference in Germany September 2007 to discuss among other things the Land-Bridge concept and a proposed tunnel across the Bering Strait. The Thistle and Shamrock Tunnel from Ireland to Scotland would be very much part of such a great worldwide project.

A similar size project to that under the Bering Straits, at 22.5 miles across, is the road bridge being built between Shanghai and Ningbo in east China. Although costs are huge, they are still a fraction of what has been laid out on the Iraq war. It is my earnest hope that this Internet edition of Mark Calney's book has as much influence as did the first edition.

PREFACE TO THE FIRST EDITION

Alan Clayton
Glasgow, October 1995

I was born a British subject, not a British citizen, because of course there is no such thing. To be British, is first and foremost not to belong to a state; but to belong, in a very real sense, to one of the most powerful and wealthy families in all of human history.

As a 'subject' of the House of Windsor my younger childhood was spent among the unquestioning conviction and certainty of British identity among family, friends and neighbors. At church, and in our youth organisations, the icons of British identity were cherished and reinforced. We sang Land of Hope and Glory, Rule Britannia, God Save the King and the other imperialist battle hymns with unquestioning fervour and conviction. In Glasgow, in 1941, I can remember late at night in an air raid shelter my grandmother sitting me on her knee and telling me stories of the great Empire on which the sun never set, which would have inevitable and ultimate victory, while outside the Luftwaffe pounded the shipyard, heavy engineering plants and armaments factories of industrial Clydeside.

Industrial Clydeside is now gone of course. A victim of a force in many respects more deadly even than war, the free market economy which sucked investment increasingly away from industries desperately in need of modernisation and research and development facilities, towards currency speculation unrelated to the physical economy. However, they were still there in 1948, when I went in the company of 90 other lads to Norway, with that great British youth organisation, the Boys Brigade. We toured from Stavanger to Bergen with a huge Union flag draped across the bus, and saw no contradiction whatsoever between that and the fact that we were Scots.

It was not many years later, however, that serious doubts first appeared in my mind about the 'great Empire', and that was when at the age of sixteen, I joined the Merchant Navy, and almost the first place I arrived in was India. The poverty staggered me; it was far beyond anything we had experienced even in the war years. Even in those early years of Independence, I recall also the poverty of spirit, the colonial cringe that still infected many Indians, and the 'cap doffing' attitude of so many people. Remnants of the colonial administration of the Raj still remained, and the arrogant strutting manner and virulent racism of most of them disgusted me. In many ways it was a disorienting experience; because if I were not British, and I was by now, far from sure that I wanted to be, then what on earth was I?

Early on, I turned to the poetry of Robert Burns to see if there was any hope of finding something of national identity and sense of purpose in the works of the poet. We were never taught Burns at school, just as, by and large, we were never taught any Scottish history. I thought of the British Raj, of Earl Mountbatten, and the generations of oligarchs that had looted India remorselessly. The third verse of Burns' great republican hymn, *A Man's a Man for A'* That came to mind, as I reflected on the arrogant Mountbatten:

Ye see yon birkie ca'd "a lord,"

Wha struts, an' stars, an' a' that?
Tho' hundreds worship at his word,
He's but a cuif for a' that;
For a' that an' a' that;
His ribband, star, an' a' that,
The man o' independent mind,
He looks an' laughs at a' that.

Later, we sailed to the United States, and what a remarkable experience that was! There was a spirit of optimism and self confidence everywhere. What Burns meant by 'The man o' independent mind' started to form in my own mind as I talked to these Americans, 'ordinary guys' as they would describe themselves; they were citizens of a state, not subjects of a king. How I envied them, not only their prosperity, but their republican spirit, their pride in their work and perhaps above all their understanding and love of the nation to which they belonged. Something of the spirit of '76 was still alive in America then, and how infectious and inspiring it was even to be in its presence. How could I take this spirit to suffering India, I wondered. The words of Burns' *Ode for General Washington's Birthday* expressed it well:

They harp Columbia, let me take!
See gathering thousands, while I sing,
A broken chain exulted bring,
And dash it in a tyrant's face.

It was to be forty years later, in 1992, before I was to return to America. I went at the invitation of friends, in a mood of expectation and optimism that was to be sorely disappointed. The big houses I remember in northern Virginia were still there, but oh, how dilapidated and run down so many of them looked, some in dire need of a coat of paint. The great steel mills were mainly gone; dereliction of the kind I knew so well in Scotland, was everywhere. And the people, even the body language seemed different, much of the self-assurance had gone. To my astonishment, many people, when they heard my accent, talked affectionately of the Queen, or even 'Her Majesty' of 'our Queen'. How the spirit of those shipyard and steelworkers of 1952 must have cringed! They would never be rude, but Queens and Majesties could never have been part of their thought-processes or their lexicon. I doubt if any of them knew much of Burns, but the words of his poem *A Dream* would have said it all for them:

For me! Before a monarch's face,
Ev'n there I winna flatter;
For neither pension, post, nor place,
Am I your humble debtor.

In the last years many Americans have betrayed the revolution by accepting 'pension, post, and place' from the House of Windsor and so become its 'humble debtor.' Britishness is a state of mind, a world view, and many Americans have become British in

every sense. Well we might ask ourselves from where now is the spirit of republican freedom to come? For Mark Calney, it will come from the words and inspiration of such as Robert Burns; and if Scotland is to be truly free it must not only read Burns but look carefully at the ideas and proposals which have been developed in this book, because they are the consequences of thought-processes which can make Scotland truly free. They are due, initially at least, to the American thinker Lyndon LaRouche, a man who knows from bitter experience the words of Burns' 'England in thunder calls, The tyrant's cause is mine.' Of LaRouche, Burns would gladly have written, 'Ye know, and maintain the Royalty of Man.'

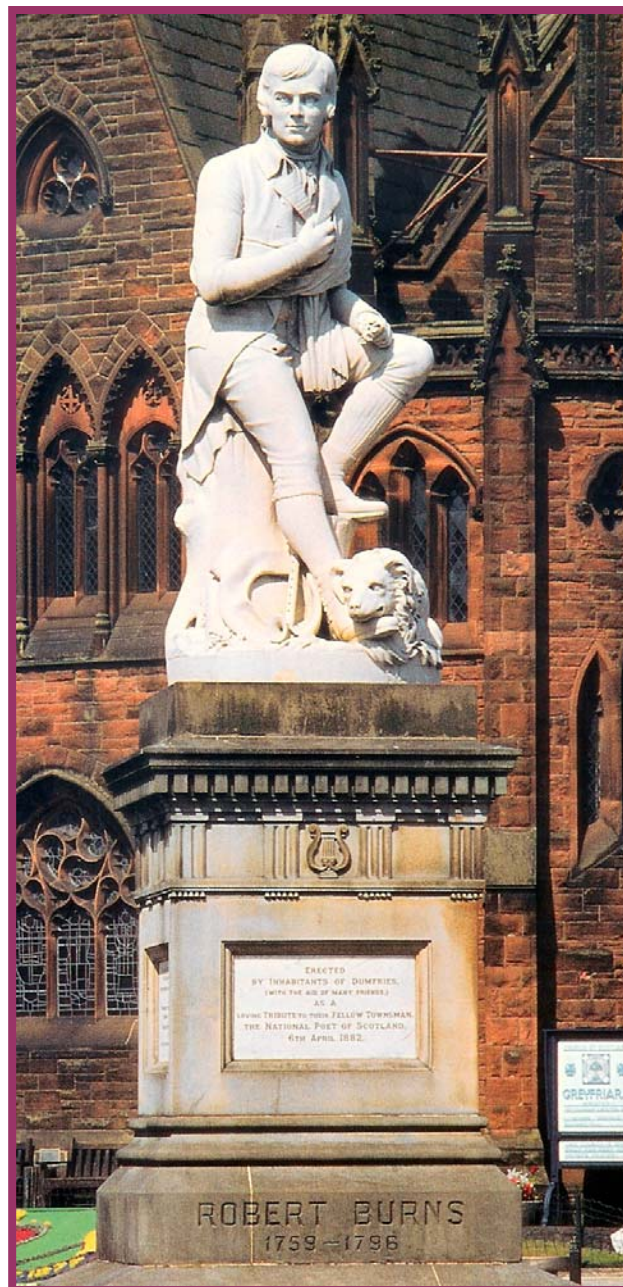

Statue of Robert Burns in Dumfries, Scotland

I. ROBERT BURNS, SCOTLAND'S NATIONAL POET OF LIBERTY

O Thou! who pour'd the patriotic tide,
That stream'd thro' Wallace's undaunted heart,
Who dar'd to nobly stem tyrannic pride,
Or nobly die, the second glorious part:
(The patriot's God peculiarly thou art,
His friend, inspirer, guardian, and reward!)
O never, never Scotia's realm desert;
But still the patriot, and the patriot-bard
In bright succession raise, her ornament and guard!

- Robert Burns
The Cotter's Saturday Night

During the autumn months of 1989, those who brought down the totalitarian regimes of Eastern Europe, chose the chorus from Beethoven's Ninth Symphony, set to Friedrich Schiller's *Ode to Joy*, as the hymn of their struggle for freedom. On October 9th of that year, as the East German dictator, Erich Honecker, led the 40th anniversary celebration of socialism in the GDR, thousands of peaceful demonstrators gathered in Leipzig. Snatches of Schiller's poems adorned their banners and posters. The police and military had received the order to shoot. Fearful that the assembled troops might not hesitate to fire upon a faceless mass, Kurt Mazur, the internationally renowned conductor of Leipzig's famous Gewandhausorchester, courageously stepped forward to place himself at the front of the demonstrators. The troops did not shoot, and exactly one month later, on the 9th of November, the Berlin Wall was opened.

Human history has reached a point of decision. The communist dictatorships of Eastern Europe have fallen. Yet, the Western economic policies of usury, Free Trade, and Malthusianism are hurtling the world towards a general financial collapse and a New Dark Age.

The need to revive study of the classical poets, including the works of Robert Burns, is crucial if human civilisation is to overcome the present crisis. Consider the following:

"When power leads man towards arrogance, poetry reminds him of his limitations. When power narrows the areas of Man's concern, poetry reminds him of a richness and diversity of his existence. When power corrupts, poetry cleanses. For art establishes the basic human truth which must serve as the touchstone of our judgment."

These are the words of President John F. Kennedy, on inviting the American poet Robert Frost to speak at his inauguration ceremony in 1961.³ This echoes Friedrich Schiller, the German poet and contemporary of Robert Burns:

“Poetry is virtually unique in its power to reunify the soul’s sundered forces, to occupy heart and mind, activity and wit, reason and the power of imagination in harmonious alliances, and, as it were, to restore the entire human being within us.”⁴

During the darkest days of the American Civil War, President Abraham Lincoln would spend many hours reciting and teaching Shakespeare to his Cabinet. Thereby, he educated and instilled in them the history of the relevant ideas, not the whimsy of public opinion, upon which the future of the nation and mankind required.

Since the time of Homer, it has been the great poets who have been the standard bearers in the struggle for Freedom. It has been their mastery of the principles of Beauty which has enabled men and women to fight for the higher good against evil. As Schiller said, "It is beauty, through which one proceeds to freedom."

Robert Burns exemplifies Schiller’s definition of the aspiration to freedom. His poetry and songs are inseparable from the ideas of the American Revolution. Indeed, Burns volunteers himself to be America’s poet in his *Ode for General Washington’s Birthday*, when he says

‘Tis liberty’s bold note I swell,
Thy harp Columbia, let me take!

There is no one in the English speaking world, and few elsewhere, who have not heard the poetry of Robert Burns. Beethoven, Haydn, and Felix Mendelssohn set Burn’s songs to music, while John Keats praised him in verse. Unfortunately, for most Americans and others around the world, their familiarity with Scotia’s bard is limited to a hoarse rendering, wetted by champagne, of his most famous composition, "Auld Lang Syne," as the clock strikes midnight on New Year’s Eve.

In Scotland, there has been a concerted effort to de-politicise and romanticise the works of Burns. In many Scottish colleges, Burns has been dropped from the curriculum.

³ Also a presentation made by President Kennedy at Amherst College in honour of the poet on October 26, 1963 in Amherst, Massachusetts; *Let the Word Go Forth, Speeches, Statements , and Writings of John F. Kennedy (1947-1963)*, Delecorste Press, New York, 1988; p. 209.

⁴ Friedrich Schiller, “On Burger’s Poems”, *Friedrich Schiller, Poet of Freedom, Volume II*, Schiller Institute, Washington, D.C. 1988, p. 422.

Were you to attend the most posh of the established Burns Suppers, following the toast to Robert Burns, you would be asked to toast the Queen of England!

Following voter approval of two public referendums in Scotland (the first being illegally nullified by Prime Minister Margaret Thatcher), on July 4, 1999, the Scottish Parliament was reconvened for the first time since 1707. Though it does not yet have the 'power of the purse,' which is critical for national sovereignty, it was nonetheless an historic moment for all Scots. During the opening ceremonies, to the vast and noticeable displeasure of the Royal Family in attendance (who attempted to cancel this portion of the proceedings), Sheena Wellington sang Robert Burns' wonderful anthem to human freedom: *A Mans A Man For A' That*. From the grave, the eternal voice of Scotia's bard was joined by that of Ms. Wellington and all the members of the new Scottish Parliament as they sang the principles of the American Revolution to the unhappy faces of the rulers of the British oligarchy.



Etching of Robert Burns reciting his "Ode for General Washington's Birthday" personally to the American President; this appeared in a 19th century American edition of Burns' works. The background painting in the etching depicts a passage from the Ode of chains being "dashed" in the face of King George III.

II. THE HISTORIC ISSUES OF BURNS' ERA

O wad some Power the giftie gie us
To see oursels as ithers see us!
It wad frae mony a blunder free us,
An' foolish notion:
What airs in dress an' gait wad lea'e us,
An' ev'n devotion!

- Robert Burns
To a Louse

The emergence of Burns as Scotland's leading poet was the result of international developments around the American Revolution. The latter half of the eighteenth century witnessed the struggle of a trans-oceanic republican movement determined to overthrow the tyranny of the oligarchical system, and usher in what Friedrich Schiller called the "Age of Reason."

Oligarchy vs. Republican Systems

Born, like Robert Burns in 1759, Friedrich Schiller defined this conflict most succinctly in his lecture entitled *The Legislation of Lycurgus and Solon*.⁵ Schiller saw history as a conflict between two opposing philosophies of law, the one exemplified by the republican reforms of Solon of Athens, and the other, the oligarchical system of Lycurgus, the mythical founder of Sparta. These two opposing systems are irreconcilable

In the oligarchical system, the idea of the State is identical with that of the empire. This is true not only for Sparta, but for its predecessors such as the Assyrian Empire, Babylon, Persia, and the later Roman, Byzantium, Ottoman and Austro-Hungarian, and British Empires. An elite holds sway over its subjects, deliberately kept in a state of

⁵ Friedrich Schiller's drama *Wilhelm Tell* draws directly from the American Declaration of Independence. In that play, before the pledge of the famous Rutli Oath, Stauffacher state's:

"Yes! there's a limit to the despot's power!
When the oppress'd for justice looks in vain,
When his sore burden may no more be borne,
With fearless heart he makes appeal to Heaven,
And thence brings down his everlasting rights,
Which there abide, inalienably his,
And indestructible as are the stars."

backwardness. The elite claims for itself the right to plunder this population through the mechanisms of usury. The oligarchical view of Man is that he is a beast, and the world a series of great cycles of birth and death, of construction and destruction. Death and destruction are considered to have a "purifying" effect, killing off the weak and enabling the strong to survive. There is no place in this system for scientific and technological progress; indeed, such progress is viewed as the real enemy threatening the eternal cycle.

THE LEGISLATION OF LYCURGUS AND SOLON

It was beautiful and fitting of Solon, that he had respect for human nature, and *never sacrificed people to the state, never the end to the means*, but rather let the state serve the people. His laws were loose bonds in which the minds of the citizens moved freely and easily in all directions, and never perceived that the bonds were directing them; the laws of Lycurgus were iron chains in which bold courage chafed itself bloody, which pulled down the mind by their pressing weight. All possible paths were opened by the Athenian legislator to the genius and diligence of his citizens; the Spartan legislator walled off all of his citizens' potentials, except one; political service. Lycurgus decreed indolence by law, Solon punished it severely. In Athens, therefore, all virtues matured, industry and art flourished, the blessings of diligence abounded, all fields of knowledge were cultivated. Where in Sparta does one find a Socrates, a Thucydides, a Sophocles, and Plato? Sparta was capable of producing only rulers and warriors -- no artists, no poets, no thinkers, no world-citizens. Both Solon and Lycurgus were great men, both were righteous men, but how different were their effects, since they proceeded from principles diametrically opposed. The Athenian legislator is surrounded by freedom and joy, diligence and superfluidity -- surrounded by all the arts and virtues, all the graces and muses, who look up to him in gratitude, and call him father and creator. About Lycurgus, one sees nothing but tyranny and its horrible partner, slavery, which shakes its chains, and flees the cause of its misery.

- Friedrich Schiller,
from *The Legislation of Lycurgus and Solon*

This corresponds to a concept of Man as incapable of change, whose "nature" is fundamentally inclined towards evil. Hence, the rule of certain men over their fellows is derived from the ability of an elite to force through its will. Law has no objective basis in this system.

In a republic, all individuals are endowed with equal, inalienable rights founded upon natural law. The state is not an instrument of power, but rather serves to allow the creative powers of each of its citizens to unfold. As citizens, they are concerned with

development of the state as a whole (this idea is reflected explicitly in the "General Welfare" clause in the preamble of the US Constitution). Science and technological development are inherent to the republican state, which rests upon the notion of Man as "imago Dei", i.e. Man created in the image of God.

Venice Invades England

The model for the British Empire was Venice⁶. Benjamin Disraeli, the late-nineteenth-century Prime Minister of Britain, bluntly put it in his novel *Coningsby*:

"The great object of Whig leaders in England from the first movement under Hampden to the last most successful one in 1688, was to establish in England a high aristocratic republic on the model of Venice...William the Third told...Whig leaders, 'I will not be a doge.'...They brought in a new family on their own terms. George I was a doge; George II was a doge...George III tried not to be a doge...He might try to get rid of the Whig Magnificoes, but he could not rid himself of the Venetian constitution."

The Venetian takeover of England was a 200-year project beginning with the break of Henry VIII with Rome, and concluding successfully with accession of George I to the throne in 1714.

The English parliamentary system of government was modeled on the Venetian system of a Great Assembly and Senate controlling the doge. In 1688, England officially became an oligarchy.

The best way to understand the evil of Venice is to look at the great poets' portrayals of her astounding duplicity, such as Christopher Marlowe's *The Jew of Malta* and *Doctor Faustus*, an attack against the Rosicrucian cult of Francesco Zorzi and Venetian takeover of England. This was also the subject of Shakespeare's *Merchant of Venice* and particularly *Othello, the Moor of Venice*. One of the most insightful examinations of the evil method of Venice is seen in Friedrich Schiller's *The Ghost-seer*, which played an important role in the education of the famous American statesman and president John Quincy Adams on the method of thinking employed by the European oligarchy.

⁶ On Venice see, ["How Bertrand Russell Became an Evil Man"](#) by Lyndon H. LaRouche, Jr., *Fidelio* magazine, Fall 1994 issue; also April 15, 1994 issue of *Executive Intelligence Review* which features ["The Venetian takeover of England: a 200-year project"](#) by Gerald Rose, and ["How the Venetian virus infected and took over England"](#) by H. Graham Lowry.

During the 15th century, when the rulers of Venice saw their power threatened by expanding Dutch trading operations, both the Netherlands and England were targeted for Venetian takeover.

The Venetian Party in the British Isles understood that politics is the battle for the mind. In 1529, Francesco Zorzi, Venetian ambassador to England, created a Rosicrucian-freemasonic party at the English court, where he remained for the rest of his life; his influence on writers like Edmund Spenser and Sir Philip Sydney was great.

It was Zorzi, who set forth the arguments for the King's divorce with Catherine of Aragon, thus sealing the alliance with Venice against Spain.

The second wave of the Venetian assault was launched by Paolo Sarpi. England was set up to become the bastion of the New Age.

Sarpi was the main propagandist against the papacy, when in 1606, there was pronounced a papal interdict against Venice. Francis Bacon, his student, took his method from Sarpi's *Arte del Ben Pensare*, which asserts that the only way an individual can know anything is through his senses. Thus was the modern school of empiricism launched, leading to the radical nominalism of David Hume.

The Ideas of 1776

On July 4, 1776, as the British Empire was engaged in its ruthless attempt to crush resistance to its dictates, the Declaration of Independence was signed in Philadelphia, Pennsylvania by the representatives of the thirteen American states. It set forth the circumstances and intent of the new American nation.

"We hold these truths to be self-evident: That all men are created equal, that they are endowed by their Creator with certain unalienable rights, that among these are life, liberty, and the pursuit of happiness.

"That to secure these rights, governments are instituted among men, deriving their just power from the consent of the governed; that whenever any form of government becomes destructive to these ends, it is the right of the people to alter or to abolish it, and to institute new government, laying its foundation on such principles, and organizing its powers in such form, as to them shall seem most likely to effect their safety and happiness."

Given their numerous contacts with Scottish intellectuals, it is highly probably that the drafters of that document, Thomas Jefferson and Benjamin Franklin, were not unaware of the Declaration of Arbroath (1320). The similarities are striking, not only in content and form. Where the Declaration of Arbroath, in calling upon Pope John XXII to recognise Scotland's independence from the Kingdom of England, states:

"It is in truth not for glory, nor riches, nor honours that we are fighting, but for freedom -- for that alone, which no honest man gives up but with life itself."

The American Declaration of Independence concludes:

"And for the support of this declaration, with a firm reliance on the protection of Divine Providence, we mutually pledge to each our lives, our fortunes, and our sacred honor."

Governments are to be based upon Natural Law, upon Reason, a law higher than that of any arbitrary will of man.

Alexander Hamilton, of Scottish descent and one America's Founding Fathers, declared in 1775:

"The sacred rights of mankind are not to be rummaged or among old parchments, or musty records. They are written, as with a sun beam in the whole volume of human nature, by the hand of the divinity itself; and can never be erased or obscured by mortal power."

The Magna Carta of 1225 is not the predecessor to the Declaration of Independence and U.S. Constitution. It was above all a real estate contract, dealing with the "property rights" and demands of England's landed nobility⁷. Though that contract may speak of "the honour of God and exaltation of Holy Church", it was neither based upon, nor argued from, the position of Natural Law.

In contrast, the Declaration of Arbroath pays no heed to "Rights of Kings." Let us examine again the most important passage:

"Yet if he [Robert Bruce – ed.] should give up what he has begun, and agree to make us or our kingdom subject to the King of England of the English, we should exert ourselves at once to drive him out as our enemy and a subverter of his own rights and ours, and make some other man who was well able to defend us our

⁷ It is often falsely asserted that the Declaration of Independence was the result of "Lockean concepts" espoused by America's Founding Fathers. John Locke was in fact the quintessential exponent of the "pursuit of property," the chief propagandist for the Venetian-designed Bank of England, imposed on that nation in 1694. Locke was also an investor in the Royal Africa Company, chartered by the Crown in 1663 explicitly for slave trading. He was an ardent defender of usury; in 1701, as a member of England's Board of Trade, he advocated revoking the independent charters of the American colonies, placing their economic activity under royal dictatorship, and banning manufacture of any finished goods!

King; for as long as but a hundred of us remain alive, never will we on any conditions be brought under English rule. It is in truth not for glory, nor riches, nor honours that we are fighting, but for freedom -- for that alone, which no honest man gives up but with life itself."

ON THE PURSUIT OF HAPPINESS

1. Virtue is the habit of acting according to wisdom. It is necessary that practice accompany knowledge.
2. Wisdom is the science of felicity, [and] is what must be studied above all other things.
3. Felicity is a lasting state of pleasure...
4. Pleasure is a knowledge or feeling of perfection, not only in ourselves, but also in others, for in this way some further perfection is aroused in us.
5. To love is to find pleasure in the perfection of another....
11. One is happy when he loves God, and God, who has done everything perfectly, cannot fail to arrange thus, to elevate created beings to the perfection of which they are capable through union with him, which can subsist only through the spirit...
15. One must hold as certain that the more a mind desires to know order, reason, the beauty of things which God has produced, and the more he is moved to imitate this order in the things which God has left to his direction, the happier he will be.
16. It is most true, as a result, that one cannot know God without loving one's brother, that one cannot have wisdom without having charity (which is the real touchstone of virtue), and that one even advances one's own good in working for that of others: for it is an eternal law of reason and of the harmony of things that the works of each [person] will follow it. Thus the sovereign wisdom has so well regulated all things that our duty must also be our happiness, that all virtue produces its [own] reward, and that all crime punishes itself, sooner or later.

- Gottfried Wilhelm Leibniz
Felicity

Though the document is an argument for the independence of the Kingdom of Scotland, it places the position of Robert Bruce as the "King of the Scots" (not the King of ScotLAND, the real estate) upon a conditional foundation. Indeed, it is a not too veiled threat to Bruce that, were he to take the side of the English against Scots, the latter would "make some other man who was well able to defend us our King." That "some other man" is an allusion to William Wallace, who, as a commoner, had earlier rallied the nation against the invasion of Edward I.⁸ The choice of who would rule the Scots had to be

⁸ Robert Bruce was motivated by the ambition to obtain the Crown of Scotland. This was achieved through much perfidy and betrayal. With the hope that "The Hammer of the Scots", King Edward I, would give him the Crown of Scotland, Bruce refused to join Wallace at the battles of Sterling and Falkirk.

based upon that individual's ability to defend an independent Scotland, and his commitment to fight for "truth" and "freedom."

The idea of the "pursuit of happiness," in the Declaration of Independence, comes directly from Gottfried Wilhelm Leibniz (1646-1716), one of the philosophical architects of the American republic, who posed this to contradict Locke's "life, liberty, and the *pursuit of property*." Where Locke defines happiness as "the utmost pleasure we are capable of," Leibniz objects:

"I do not know whether the greatest pleasure is possible. I believe rather that it can grow ad infinitum... I believe then that *happiness is a lasting pleasure*; which could not be so without there being a continual progress to new pleasures. . . Happiness is then, so to speak, a road through pleasures; and pleasure is merely a step and advancement towards happiness, the shortest which can be made according to the present impressions, but not always the best. The right road may be missed in the desire to follow the shortest, as the stone which goes straight may encounter obstacles too soon, which prevent it from advancing quite to the centre of the earth. This shows that it is *the reason and the will which transport us towards happiness, but that feeling and desire merely lead us to pleasure...*

"True happiness ought always to be the object of our desires, but there is ground for doubting whether it is. For often we hardly think of it, and I have remarked here more than once that *the less desire is guided by reason the more it tends to present pleasure and not to happiness that is to say, to lasting pleasure...*"⁹ (emphasis and punctuation added).

As the leading scientist and philosopher of his day, Leibniz was well known to republican leaders of the American colonies, like the Winthrops and Mathers, with whom he corresponded. In 1710, Cotton Mather's *An Essay Upon the Good*, spread Leibniz's notion of the science of happiness throughout America. Benjamin Franklin paid tribute to this book as the single most important influence upon his life.

In an attempt to nullify the influence of Leibniz, the Venetian/British Secret Intelligence Services (SIS) begat a host of charlatans: Sir Isaac Newton, David Hume,

Some chroniclers have even put Bruce in the camp of Edward during the battle of Falkirk. In 1305, Bruce was residing at the Court of King Edward II when he received a summons from Wallace. Bruce sent word that he would meet Wallace on the Glasgow Moor on the first night of July, but never appeared. After several nights, Wallace was captured by sixty armed men, and carried to London where he was put to death.

Though later, Bruce would take up the fight against the English king, those who drafted the Declaration of Arbroath were well aware of the duplicitous capability of Bruce and many of the Scottish barons. This is witnessed by the fact that three of the barons who had signed the Declaration were later convicted of treason the following August.

⁹ G.W. Leibniz, *New Essays on Human Understanding*, Philip P. Weiner, ed., Charles Scribner's Sons, New York, 1951, pp. 437, 439.

Adam Smith, Jeremy Bentham, and Lord Bertrand Russell. This is why Leibniz is virtually unknown in Scotland today. However, this was not always the case.

Leibniz's threat to the infant British Empire was not limited to the realm of ideas. The Electress Sophia of Hanover, until her untimely death in June of 1714, was the protector and student of Leibniz. As a result of Leibniz's historical researches thirteen years earlier, combined with the actions of his allies in England, Sophia had been established as the next in of succession to the British throne.

In order to circumvent the real possibility that Leibniz would become the next Queen's Prime Minister, London's Royal Society concocted the "Newton-Leibniz controversy" over priority in who discovered calculus, as a means of defaming and discrediting Leibniz in England. On April 12, 1712, Leibniz was officially condemned as a thief and plagiarist of Sir Isaac Newton, in a Royal Society report authored by Newton himself! This event defined the moral dividing line in science and politics throughout Europe.

Leibniz became clearly identified as the leading adversary of British philosophy. The intellectual leadership of colonial America openly sided with Leibniz against Newton and the British establishment.¹⁰

When Sophia died on June 8, 1714, followed by the death of Queen Anne on August 1, the succession passed to Sophia's anti-Leibniz son, George Louis, a long-time paid asset of the imperialist faction. The new King George I refused Leibniz permission to enter England, his ally Robert Harley was arrested, and Jonathan Swift fled to Ireland.

Only with the death of Leibniz on Nov. 14, 1716, did the imperialist faction feel secure in their control over Great Britain. The Scotsman John Ker attempted one final meeting with Leibniz, in a desperate attempt to save the situation. Ker reports:

"I arrived in Hanover in the Month of November 1716, on the very Day the late famous Monsieur de Leibniz died, which plunged me into so much Sorrow and Grief, that I cannot express it. I shall not pretend to give the Character of this incomparable Senator, for more able Pens have already made Encominums upon this truly great Man, whose very meritorious Fame must continue while Learning or the World endures; . . .

"I must confess it afforded me Matter of strange Reflection, when I perceived the little Regard that was paid to his Ashes by the Hanoverians; for he was buried in a few Days after his Decease more like a Robber than, what he was, the Ornament of his Country."¹¹

The most active supporter of Leibniz in the American colonies was James Logan (1674-1751), born in Ulster, the son of a Scots Quaker schoolmaster. In 1699, when

¹⁰ For more on Leibniz's influence on America, see ["From Leibniz to Franklin on 'Happiness'"](#) by David Shavin, *Fidelio*, Vol XII, No. 1, 2003.

¹¹ *Memoirs of John Ker of Kersland*, John Ker, London, 1727, Part I, pp. 117-118.

Logan was selected by William Penn to be his secretary and accompany him to Pennsylvania, he had taught himself Latin, Greek, Hebrew, French, Italian, and Spanish (he later undertook learning Arabic, Persian, and Syriac at age 70), and had already begun his lifelong studies of mathematics, astronomy, and the physical sciences. With the passing of Penn in 1718 until his death in 1751, Logan was the leading political and intellectual figure of the colony, holding various offices from mayor of Philadelphia, president of the Assembly, Chief Justice and Lieutenant-Governor. The young Benjamin Franklin, who frequented Logan's library (with 2,651 volumes, it was the largest in the colonies) and listed him among the members of his Junto association, received his first substantial job for his new printing business from Logan in 1731.

It was during that period, when regular meetings of the Junto met at his home that Logan resolved to write his own refutation of Hobbes, Locke, and Newton. In 1735, he began his work *The Duties of Man as they may be Deduced from Nature*, which was "lost" until 1971, when it was rediscovered amongst a pile of documents bequeathed to the Historical Society of Pennsylvania, where the 400 page manuscript lies unpublished today.¹²

In that document, Logan echoes Leibniz in his attack against Locke's denial of the existence of "innate ideas," reducing morality to the arbitrary rules of the lawgiver. Logan's thesis is that all morality is naturally "implanted" in human beings, and cites the work of Homer to show that human morality existed before any written laws. He points out "that the most barbarous Nations, as the American Indians, and African Negroes, who more closely pursue Nature, *rather exceed in parental affection, than come short of the more civilized matrons. . .*" (emphasis added).

Scottish Roots of the American Revolution

When Robert Burns was born in Alloway in 1759, the county of Ayrshire was known as a focus of unrest. A number of Scots played key roles in the creation of the United States of America. This goes back to the late 1600s, with people like Robert Hunter who was born in Ayrshire. Hunter was a poet, playwright, and political satirist. He was appointed Lt. Governor of Virginia by Lord George Hamilton, the Earl of Orkney whom Queen Anne had made Governor of same British colony. Hunter later became the Governor of New York. Alexander Spotswood, another pro-republican Scot, became Lt. Governor of Virginia after Hunter. In 1737, Spotswood, then Postmaster General of the American colonies, appointed Benjamin Franklin Deputy Postmaster General in Philadelphia.¹³

¹² Thanks to the efforts of friends of the author, this handwritten manuscript by James Logan has been transcribed and is now available on the internet: [The Duties of Man as they may be Deduced form Nature](#).

¹³ On, especially the role of Jonathan Swift, see the book *How the Nation Was Won, America's Untold Story 1630-1754*, by H. Graham Lowry, Executive Intelligence Review, Washington D.C., 1987.

James Logan was a frequent correspondent of Governor Hunter and William Burnet, the 1720 successor of Hunter. Logan's letters reveal that those American leaders were well aware of the political implications of the Newtonian tyranny, including the witch-hunt against Leibniz.

In a letter dated Feb. 7, 1727, Logan, outraged over the third edition of Newton's *Principia* which had eliminated even the cursory mention of Leibniz's name as an independent discoverer of the calculus, wrote to Burnet:

"Tis certain the world was obligated only to Leibniz for the publication of that method, who was so fair as to communicate it in a great measure to Oldenburg in 1677, when Sir Isaac was so careful of concealing his, that he involved it in his Letter [of] 1676 in strange knots of Letters, that all the art & skill of the universe could never Decipher."

In another letter to Burnet, May 10, 1727, Logan wrote:

"He [Newton –ed.] is, however, great, but a man, & when I last saw him in 1724 walking up Crane Court & the stairs leading to the Society's Room, he bent under his Load of years exceeding unlike what they have Represented him two years after as in Body. *'Tis but reasonable to expect a declension elsewhere*, so that for his own honour as well as the Nation's, to which he has been a very great one, had he & Queen Anne both been gathered to their Ancestors by the year 1710, before that fierce, unnatural Dispute broke out between him and Leibniz, which I always believed, *was blown up by the forces of the society in opposition to the house that had so long employ'd Leibniz. . .*" (emphasis added).

The Newtonian tyranny was also evident in Scotland. Cadwallader Colden, a New Yorker who was a close scientific and political collaborator of Benjamin Franklin's, had written his own study of the Leibniz-Newton controversy.¹⁴ From one of his colonial correspondents, Alexander Garden of South Carolina, the following:

¹⁴ The correspondence between Colden and Franklin (*The Letters and Papers of Cadwallader Colden*, New York Historical Society, 1923) document their anti-Newtonian principles. In a letter of April 23, 1752, prior to Franklin's famous kite experiment, Franklin rejects the Newtonian "particles and the void" dogma, proposing that electricity may very well be that "subtle elastic fluid" which fills the "regions above our atmosphere." Well aware of the scientific and technological revolution he was about to unleash, Franklin told Colden, "There are no Bounds (but what Expense and Labour give) to the Force Man may raise and use in the Electric Way." Franklin's kite experiment proved that the static electricity collected in bottles was of the same nature as that of a powerful bolt of lightning. Thus the aphorism concerning Benjamin Franklin – "He stole lightning from the Heavens, and the sceptre from Tyrants" – assumes its true significance, since the one achievement was a lawful prelude to the other.

Nov. 22, 1755: “. . . What you lastly observe about Mr. Leibniz gives me great pleasure, for tho I believe your principles are sufficiently supported by your consequent natural account of Phenomena, yet so great an authority is very agreeable.”

Jan. 10, 1757: “I have just now copied over your very ingenious reflexions in the Newtonian and Leibnizian Controversy to send to the Edinburgh Society. . . .”

April, 15, 1757: “He [Dr. Whytt of Edinburgh] received your former Letter to me with great joy and satisfaction, but says he is afraid that some of the Socii will (they are all rigid and literal Newtonians) have their objections. He was to read it before them at first meeting. I have sent him your observations on the Leibnizian Controversy.”

James Alexander, an heir to the Scottish earldom of Stirling, was deported to the American colonies for his role in the 1715 rebellion. He became a protégé of Robert Hunter, who knew his family in Scotland. Alexander became a well known astronomer; he was a member of Benjamin Franklin's Philosophical Society, the first organization which established a form of union between the various American colonies. Alexander's son became a general in the Continental Army during the War for Independence.

After the Scottish uprising of 1715 and the Battle of Culloden in 1746, the savage occupation policies of the English drove many Scots and their families to the American colonies. The family of John Marshall, the first U.S. Supreme Court Justice, and Admiral John Paul Jones¹⁵, the naval hero of the American Revolution, are but two examples.

¹⁵ John Paul Jones was born in 1747 on the estate of the Craik family in Kirkbean, near the Solway Firth. His father, John Paul, Sr., was the estate's gardener. The lord of the estate, William Craik, was an inventive agriculturist. His son, James Craik, became a surgeon who moved to America and became a devoted friend of George Washington. Jones was the only American military leader to have fought the British on their own territory. Though only sorties were attempted, Jones terrified the enemy. While Jones commanded the *Ranger*, he staged a raiding party in 1778 on the fort and harbour of Whitehaven, England across the Firth of Solway from Kirkcudbright. Sir Walter Scott later told James Fenimore Cooper of the turmoil which Jones' ships had caused in Edinburgh. The three small companies of British soldiers in Edinburgh were transformed into 5,000 men. One citizen wrote:

"Jones and his myrmidons frighten the people more than Charley did in the late rebellion. Everyone was for securing his effects by hiding them; the three banks had all their money packed up and ready to be sent off..." [Filken, "St. James Chronicle," September 30, 1790].

During 1790, Robert Burns was introduced to Helen Craik of Arbigland by Robert Riddell. According to Burns biographer James Mackay, Burns was probably introduced to his Dumfries landlord, Capt. John Hamilton, by Helen Craik.

III. THE SECRET HISTORY OF BRITAIN'S INDUSTRIAL REVOLUTION

I'm now arrived - thanks to the gods! -
Thro' pathways rough and muddy,
A certain sign that makin roads
Is no this people's study:
Altho' I'm not wi' Scripture cram'd,
I'm sure the Bible says
That heedless sinners shall be damn'd,
Unless they mend their ways.

- Robert Burns
Epigram on Rough Roads

Two centuries ago, there were no "industrial nations" on this planet. England, for example, had less industry than terribly poor countries do today. The United States of America was a rural backwater. France, the richest country in 1750 was completely stagnant. Nowhere in the world were there any factories in the modern sense, no machines powered by artificial means, no industries run on scientific lines.

The Western powers did not become industrialised *gradually* over these 200 hundred years. Rather, there were suddenly very distinct bursts of invention, and sharply defined periods of growth. Britain's leap from backwardness into the Industrial Revolution began in the 1760s. In America, the great transformation took place in the 1830s and 1840s, and again to a higher level in the 1870s and 1880s.

Mankind's survival now requires such a great stride. But can it be repeated, and would it be desirable to repeat the process today? These questions are now usually answered in the negative, because the world has accepted a package of lies and historical myths about what caused modern times.

Free Trade and Marxist historians both claim, that when medieval restrictions were lifted, and "capitalists" were allowed to do whatever they wanted with their money, they turned their investment toward the greatest profit; thus; freedom to be selfish caused the new industry to appear!

Oxford historian Arnold Toynbee wrote:

"The essence of the Industrial Revolution is the substitution of competition for the medieval regulations which had previously controlled the production and distribution of wealth. On this account, this historical theory, is not only one of the most important facts of English history, but Europe owes to it the growth of two great systems of thought -- economic science, and its antithesis, socialism."

But *how* revolutionary new technology suddenly appeared, supposedly without forethought or strategic purpose, is a mystery for which Free Trade and Communist

theorists supply the same silly solution. Adam Smith claimed that various bored, uneducated workers, made the most important inventions to lighten their work. In his *Wealth of Nations*, Smith tells us:

"In the first fire-engines [steam engine – ed.] a boy was constantly employed to open and shut alternately the communication between the boiler and cylinder...One of these boys, who loved to play with his companions, observed that, by tying a string from the handle of the valve which opened this communication to another part of the machine, the valve would open and shut without his assistance, and leave him at liberty to divert himself with his play-fellows. One of the greatest improvements that has been made upon this machine, since it was first invented, was in this manner the discovery of a boy who wanted to save his own labour."

Since such a "discovery" is perfectly accidental to the purpose of the enterprise, the motive for the story is to reinforce the lie told by Free Trade and Communist theorists alike: that national progress can never occur by the *design* of free men, but only as the chance result of selfishness, or through dictatorship.

In *Capital*, Marx quotes from the spokesman for the British East India Company (and student of Jeremy Bentham) John Stuart Mill:

"It is questionable if all the mechanical inventions yet made have lightened the day's toil of any human being."

Marx tells us that the aim of capitalist application of machinery is only to reduce the workers' share of the pie. The attacks we witness today by the media and radical environmentalists against industrial development, echo the *Communist Manifesto*:

"The unceasing improvement of machinery, ever more rapidly developing, makes workers livelihood more and more precarious."

But the secret to modern history, is that all the great breakthroughs in technology and living standards were conscious schemes to better the lot of humanity, guided by the principles in the American Declaration of Independence.

Prometheus of the 18th Century

There is one individual who should be credited with organising the American Revolution: Benjamin Franklin, known as the "Prometheus of the 18th century." He was

the father of electricity, and the leading scientific figure of his day. To him, Beethoven dedicated his 9th Symphony.

Franklin organised the international conspiracy of scientists, artists, and political figures which won the American War of Independence. It was the inspiration for similar republican movements that were to come to power throughout the world. It was also Benjamin Franklin who organised the industrial revolution in the British Isles. This included the steam engine project and the work of James Watt, as well as setting up in Scotland what became Europe's largest iron works.

Benjamin Franklin's Scottish friends played a crucial role in Robert Burns' career, in particular, Rev. Dr. Thomas Blacklock, the blind scholar of Edinburgh.

In 1786, Burns' first collection of poems was published in a limited, local edition, commonly referred to as the "Kilmarnock Edition" (*Poems Chiefly in the Scottish Dialect*). If not for the intervention of Dr. Blacklock, Robert Burns might well have become the national poet of Jamaica, and not of Scotland. Plagued by personal problems, Burns had decided to escape his troubles by sailing for the West Indies. As Burns later wrote:

"I had taken the last farewell of my friends; my chest was on the road to Greenoch; I had composed my last song I should ever measure in Caledonia...when a letter from Dr. Blacklock to a friend of mine overthrew all my schemes by rousing my poetic ambition. The Doctor belonged to a set of Critics for whose applause I had not even dared to hope. His idea that I would meet with every encouragement for a second edition fired me so much that away I posted to Edinburgh without a single acquaintance in Town."¹⁶

It was Blacklock's bigger plan to bring out a second edition of his poetry, that kept the Bard in Scotland.¹⁷

The Old Man, in Person

In the spring of 1757, Dr. Franklin sailed to England for his second visit, as the official representative of the colony of Pennsylvania. His achievements, by that time, had included:

¹⁶ The *Autobiography Letter* from Burns to Dr. John Moore, August 2, 1787.

¹⁷ After the 1787 Edinburgh edition of Burns poetry, the third and fourth printing of his works occurred in America in 1788; in Philadelphia by Stewart & Hyde (the first American edition) and in New York City by J. & A. M'Lean. The fifth printing was a pirated one published in Dublin.

- * The founding of the Philosophical Society, the first organisation uniting the American colonies. Subcommittees of the Society were then planning to set up native industries, illegal under the latest repressive colonial statutes.
- * His published scientific experiments had elucidated the nature of electricity.
- * As colonial Postmaster, he had established regular communication within America. Inexpensive newspapers, including Franklin's own publications, brought up-to-date intelligence to the colonialists.
- * He had established and trained the Pennsylvania militia, and had helped Col. George Washington to stop terrorism along the Western border.

Corresponding with a worldwide circle of scientists and intellectuals, Franklin was chief of intelligence for the American nation about to be born.

When Franklin arrived in the British Isles, they were very backward. There were virtually no roads between cities, no canals, and no railroads. Iron, cloth, or grain could not be shipped overland except in the saddlebags of a packhorse, and only when the mud was down. All manufacturing was done on a small scale by local operatives or in rural dwellings. London had great wealth from world trade and finance, but it was the capital of an undeveloped country.

The project to industrialise Great Britain began shortly after Franklin's arrival, among a small circle of his political and scientific collaborators.

Though its results were to be of great benefit to the general population, the project was at times subject to harassment. It was therefore carried out with prudence and sometimes secrecy.

One of Benjamin Franklin's associates was the fellow printer and type designer, John Baskerville, who in 1757 had published a handsome edition of Virgil, to which Franklin had subscribed. In 1758, Baskerville was appointed printer to Cambridge University. That year Franklin attended the commencement exercises.

Franklin then travelled to the city of Birmingham, meeting with Baskerville and his own family relations. He also carried a letter from John Mitchell, a pioneer seismologist, astronomer, and magnetic scientist, who was also Professor of Greek and Hebrew at Cambridge. Mitchell's letter was to Matthew Boulton, Jr., son of a buckle and button manufacturer:

"to introduce...the best Philosopher of America, whom you are already very well acquainted with though you don't know personally."

No later than the summer of 1758, Franklin and Matthew Boulton, Jr. began work on electricity, metallurgy, and the harnessing of steam power. Their collaboration, at times surreptitious and subject to police surveillance, continued until Franklin's death in 1790.

Franklin became tutor, science advisor and political counselor to Boulton's closest friends, including the potter, Josiah Wedgwood, and Boulton's personal physician, Erasmus Darwin. Along the line of Franklin's secret society, the Junto of Philadelphia, the Birmingham group became known as the Lunar Society. It was to become most influential.

The Manchester Project

John Gilbert, a former apprentice in the shop of Matthew Boulton, Sr., was employed in 1757 as the manager of the Bridgewater lands and coal mines at Worsley. His brother, Thomas Gilbert, was estate manager for the Bridgewater and Gower families.

During 1757, the 21 year-old Francis Egerton, Third Duke of Bridgewater, came into possession of his inheritance, notably lands in London, and the Worsley estate located in an agricultural area 10 miles west of Manchester.

John Gilbert turned the perennial problem of mine flooding into a technologically unprecedented aid to navigation. He proposed digging an *underground canal* in the mine itself, straight through the side of a hill. In this way, newly-mined coal could be loaded directly onto barges, and the drainage from the mine would serve to maintain water levels in the canal on its course overland towards Manchester.

At the time, there were little more than 6,000 houses in Manchester. No factories using coal for steam power existed. Wood was the fuel for hearth fires throughout England. Thus, there was no market whose "logic" Bridgewater was obeying, when he decided to pursue the project. There were also no other canals in England.

Excited by Gilbert's proposal, the Third Duke of Bridgewater devoted his life to the construction of canals. Secret preparation began; land in and around Manchester was bought up.

Finally, an act was put through Parliament, giving the Duke the right to compel landowners along the route to sell him their property. The act stipulated that, for the next 40 years, the coal delivered from the Worsley mines would cost at no more than 4 shillings per hundredweight, compared to the pre-canal average price of 7 or 8 shillings. Freight tolls were to be kept at a fixed limit, and manure was to be toll-free.

The Duke was not a "capitalist", but a heavily encumbered landowner. He exhausted his personal funds early on. The Gilbert brothers issued very small denomination bonds, which were sold to local merchants; the Duke borrowed from his tenants. There was no backing from London banks, and no net profit in the enterprise for the first 15 years.

The Duke paid fair prices to displaced landowners. He hired more and more coal miners, paid them good wages, and secured decent living conditions for his workers in new cottages.

The Bridgewater canal was begun in 1759, and included a graceful aqueduct.

It was completed in 1761. Thousands of people began moving into the city and starting families there, as there was a secure supply of cheap Worsley coal for heating.

There were well-paid jobs; with a new labour supply and cheap fuel, a quantity of new manufacturers was set up. A greatly expanded canal system, and steam-powered machinery, would soon complete the amazing, virtually overnight emergence of an industrial centre.

By 1790, workmen from the new textile mills could be seen walking Manchester's streets, with five-pound notes protruding from their hats. Yet 50 years later, the city had become notorious for the horrible poverty and cruelty in its mills, and for the so-called Manchester School of economic thought, which claimed that the unrestricted freedom to do ill to one's neighbor was the cause of England's technological development.

The Gilbert brothers had employed one James Brindley as chief consulting engineer, to work under the supervision of John Gilbert. Historians have described Brindley as author, designer, and manager of the canal projects, when he was not even the chief engineer, while the Duke of Bridgewater was written off as a venturer of capital, and John Gilbert blacked out. Thus, the project's purpose -- to transform a backward country -- has been kept from public view.

Matthew Boulton, Jr., after inheriting his father's buckle-making shop in 1759, built England's first great manufacturing plant, the *Soho works* outside Birmingham, powered at first by a water wheel.

After the success of the Bridgewater canal, a partnership of the Duke, the Gilbert brothers, Josiah Wedgwood, Erasmus Darwin, and Matthew Boulton was formed to extend the canal from Manchester to the port of Liverpool, and then to connect Hull, Bristol, and London.

Thomas Bentley, a classical scholar who was Wedgwood's business partner, and Erasmus Darwin wrote pamphlets and letters to broaden the vision of the British people.

Wedgwood and John Gilbert coordinated negotiations with Liverpool merchants. Thomas Gilbert entered the House of Commons in 1763, adding to the political force of Bridgewater and Leveson-Gower in the House of Lords.

On May 22, 1765, as the group feverishly negotiated, planned, and lobbied for the expanded canal company, Benjamin Franklin launched a new project.

From London, Franklin wrote to Boulton:

"To introduce my friend Doctor Small to your acquaintance...an ingenious philosopher and a most worthy honest man" and to ask, "if any thing new in magnetism or electricity or any other branch of natural knowledge has occurred to your fruitful genius since I last had the pleasure of seeing you, you will by communicating it, greatly oblige."

Dr. William Small, a native Scot, had emigrated to Virginia in 1758 to teach science and mathematics at William and Mary College in Virginia, where many future leaders of the American republic were being trained. Dr. Small and the law professor George Wythe, their mutual student Thomas Jefferson, and Governor Francis Faquier often formed a string quartet.

When an anti-republican administration took over of the college, Small returned to England with Franklin in 1764. The following year, Small accepted the Old Man's assignment coordinate the development of a practical steam engine.

On Franklin's recommendation, Matthew Boulton accepted William Small as his personal physician and industrial manager. The pace of activity at the Soho plant increased forthwith.

The canal partnership with the Duke was formalized in July 1765. Early the next year, a bill authorising the cutting of the canal to Liverpool was being steered through Parliament, towards a Commons committee whose chairman was Thomas Gilbert.

In February 1766, Franklin testified to Parliament against the Stamp Act. He warned that the British Empire would fall unless it ceased to loot the colonies.

On February 22, 1766, Parliament repealed the Stamp Act. On the same day Matthew Boulton wrote Franklin in London:

"The addition you have made to my happiness in being the cause of my acquaintance with the amiable and ingenious Dr. Small deserves more than thanks...I introduce to you my good friend Mr. Samuel Garbett...a zealous advocate for Truth & for the rights of your oppressed Countrymen...My engagements since Christmas have not permitted me to make any further progress with my fire-engines....Query, -- which of the steam valves do you like best? Is it better to introduce the jet of cold water at the bottom of the receiver...or at the top? Each has its advantages and disadvantages...if any thought occurs to your fertile genius which you think may be useful, or preserve me from error in the execution of this engine, you'll be so kind as to communicate it to me..."

Boulton and Small had built a model steam engine. It was then in Franklin's hands in London, and was attracting more and more attention.

Samuel Garbett was to play an important role on the Scottish flank of Franklin's industrialisation plan.

Though certain primitive steam engine-type devices were already in use, involving hot water vapor, such as the Newcomen engine, Franklin made various suggestions to burn the fuel more efficiently. This problem was finally solved at Soho.

Having won over Parliament, Boulton, the Gilberts, and the Duke initiated canal projects all over England. James Brindley was often the engineer.

Soon "canal mania" changed the face of the island; Great Britain took to the use of coal for fuel from distant mines, instead of cutting down local timber stands. The mass manufacture of iron and steel was now practicable.

James Watt

In 1767, the Scottish mechanic-engineer James Watt went to visit the Soho works and met there with the manager, Dr. William Small. They talked of Watt's own recent experiments with steam power in Scotland, in partnership with the chemist Dr. John Roebuck in Scotland.

Dr. Small wrote to Watt, January 7, 1768, proposing the creation of a new firm:

"...you should settle here, and Boulton and I assist you as much as we could...I have no kind of doubt of your success, nor of your acquiring fortune, if you proceed upon a proper plan as to the manner of doing business; which, if you do, you will be the sole possessor of the affair even after your patent has expired...I should not hesitate to employ any sum of money I can command on your scheme...Boulton and I would engage...provided you will live here."

James Watt, though making scientific instruments for the faculty at Glasgow University, was a zealous student of music. He learned to repair violins, flutes, and guitars. He studied harmonic theory, and in building a full-scale organ, he devised a new means of regulating the stops, the tuning, and the air pressure of the instrument.

Watt then studied the available French and Italian literature on steam research; he conducted rigorous experiments on gas dynamics.

While repairing a broken Newcomen engine, he conceived of the separate condenser, the eventual basis of a practical steam engine. He led the steam away from the main cylinder, liquefied it with a cold jet, reheated and brought it back into action; the cylinder remained hot and thus did more work with less fuel.

In negotiations to set up the world's first steam engine business, William Small prepared a patent for Watt, tentatively approved on January 6, 1769.

With constant encouragement by Dr. Small, Watt finally moved to Birmingham in 1774; the partnership of Small, Boulton, and Watt, under Small's patient and scientific management, pressed on and completed their first successful machine late that year.

The Soho group invested perhaps £50,000 there, with no real profits until the 1780s.

The Soho steam engine became the driving force for the industrial revolution after a last, crucial improvement was made. At first, the piston was packed with stuffing material, to close the gap with the cylinder wall and prevent the loss of steam pressure and force. The cast iron cylinder could never be shaped evenly enough for a tight fit around the piston. Boulton proposed to iron master John Wilkerson that his machine tool for boring out cannons be modified to produce an engine cylinder.

Wilkinson's cylinder borer succeeded brilliantly, and Soho now made powerful, efficient steam engines, which Wilkinson used to run his furnace bellows, and to turn his machines. Here was the birth of many industries at once. Wilkinson produced all the tools and machine parts for Soho, and Wilkinson and Boulton jointly launched modern English copper mining. Mary Wilkinson, his daughter, married Joseph Priestly.

End of the Republican Enterprise

The firm of "Small, Boulton, and Watt" was incorporated in 1774, as the American Continental Congress first met. War approached. The cry of "treason" was raised against those who were known to be friendly towards the colonies; mob violence and prosecution threatened them.

On February 25, 1775, at the age of 41, William Small suddenly died. No one bothered to assign a cause of death, and in a climate of fear, his body was thrown into an unmarked grave.

After Small's death, the Birmingham group was re-organised into a more clandestine association known as the Lunar Society; Benjamin Franklin's close friend Joseph Priestly (the discoverer of "air" and carbon dioxide) would never speak openly about it, until many years later.

Major John Cartwright, founded The Society for Constitutional Information in 1784. Cartwright had refused a commission to fight the Americans, declaring that as human rights come from God, they cannot be taken away by man. Later, between 1812 and 1815, he toured Scotland, establishing the pro-republican Hampden Clubs (named after John Hampden, Parliamentary hero of the English Civil War period). His brother Edmund Cartwright, a republican clergyman, invented the power loom in 1784, and applied Boulton and Watt engines for the first time to textile manufacturing.

Boulton and Watt toured France in 1787 as guests of the government. Wilkinson was now supplying the French with cannons and other vital military equipment.

By 1791, the party of Lord Shelburne had mounted a counterattack against the republican movement. Their slogan was "down with the French Revolutionists." On July 14, 1791, as an officially sanctioned "rioting mob" sacked and burned Joseph Priestly's home and laboratory, and two churches where he preached. Troops lead by Shelburne's Scottish lieutenant, Henry Dundas, marched into Birmingham to "restore order." Priestly fled to America. After the so-called riot, Watt attended the next Lunar Society meeting toting a pistol. But the Society was crushed and had to be disbanded. Cartwright, Thomas Paine, and others fled to France.

Thus, a project for science and industry, which might have been extended to develop the entire world in short order, was aborted in England. The enterprises begun in the 1760s and 1770s had created such immense public wealth that they could only be checked, not erased. Aside from her role in the applying steam power to rail transport, Great Britain would never again introduce strategically important technology to the world.

IV. BENJAMIN FRANKLIN IN CALEDONIA

"On the whole, I must say, I think the time we spent there, was six weeks of the dearest happiness I have met with in any part of my life; and the agreeable and instructive society we found there in such plenty, has left so pleasing an impression on my memory, that did not strong connections draw me elsewhere, I believe Scotland would be the country I should choose to spend the remainder of my days in."

- Letter from Benjamin Franklin to
Lord Kames, January 3, 1760

Unfortunately, much of Franklin's Scottish papers vanished with his trunks deposited at the Galloway residence in Trevoise, Pennsylvania. The house was looted by British soldiers during the Revolutionary War, just as the English removed Scottish state documents after the invasions in the late 13th century and early 14th century, and under Cromwell. However, there is much that we do know about Franklin's Scottish connections.

In the summer of 1759, Benjamin Franklin, then Agent for the Province of Pennsylvania and in his 54th year, left his lodging at No. 7 Craven Street in London on his way to Scotland.

He and his son William had moved to Craven Street shortly after they arrived at Falmouth in 1757. Benjamin remained there until his departure for Philadelphia in 1761. He returned in December 1764 and stayed until 1775.

Franklin's trips to Scotland were not holiday excursions. The aim was intelligence, recruiting, and organising.

Franklin's Scottish relations go back to his early days in Philadelphia. Many of the Scots he had known in America included Andrew Hamilton, who designed the Pennsylvania State House, James Burd the Indian fighter from Tinian near Susquehanna, Professor Alexander Alexander from the faculty of the college of Fourth Street, Barclay of Urie, Comptroller of the Port of Philadelphia, and Thomas Greame the Aberdonian who had been one of the founders of the American Philosophical Society. Then there was Davey Hall ("Edinburgh Davey") who had come over to Philadelphia in 1744 and had become Franklin's partner in 1748. Davey had previously been employed at William Strahan's printing shop in London.

The average Englishman of that period thought of the Scots as a race of impecunious adventurers who had swarmed into London to engross positions and achieve careers at the expense of the native-born. The hatred was so intense that many Scots residing in London anglicised their names; Strachan became Strahan and Menzies became Mengis.

Many of Franklin's closest friends in London were of Scottish origin, such as Caleb Whitefoord, a wine merchant who lived next door on Craven Street. This tie was

so well known that in 1782 the British Foreign Office sent Whitefoord as envoy to negotiate a peace settlement with Franklin to end the War of Independence. Whitefoord boasted that his friendship with Franklin had saved a year of warfare.

Other Scottish associates included, John Fothergill, Franklin's physician in London and Sir John Pringle, a close friend and scientist who travelled with Franklin to Germany and France.

William Strathan, an Edinburgh born printer active in London, with whom Franklin corresponded for 20 years, was his banker, adviser, publisher, and guide. He was also David Hume's printer. The American Revolutionary War created a rift between Franklin and Strahan, witnessed by Strahan's remark:

"Look upon your Hands, they are stained with the blood of your Relations. You and I were friends. You are now my enemy..."¹⁸

Though later he corresponded with Franklin when he was American Envoy to France.

Franklin also frequented the London tavern where Scots gathered, the British Coffee House in Cockspur Street, run by a Scots-woman, Mrs. Anderson, whose brother was the Bishop of Salisbury.¹⁹ Those whom Franklin meet at the British Coffee House included Rev. William Robertson, later to become the Principal of Edinburgh University, who in the summer of 1759 was working on a manuscript for his *The History of Scotland, During the Reign of Queen Mary and of King James VI*. It would become the historical reference source for Friedrich Schiller's drama *Mary Stuart*.

The Scotland tour was the idea of Dr. Patrick Baird of the University of St. Andrews, who had lived in Philadelphia and been a member of Franklin's Junto. Baird had organised the Rector of St. Andrews, David Shaw, to confer upon Franklin an honorary degree in 1759:

"Conferred the Degree in Laws on Mr. Benjamin Franklin famous for his writings on Electricity and appoint his diploma to be given him gratis, the Clerk and Arch Beadle's dues to be paid by the Library Questar."²⁰

¹⁸ Strahan letter to Franklin, February 13, 1778, American Philosophical Society, vol. 44, p. 21.

¹⁹ The British Coffee House is perhaps best described in *Scottish Men of Letters in the Eighteenth Century*, by Henry Gray Graham, London, 1908.

²⁰ Minutes of the Incorporated Colleges of St. Salvator and St. Leonard (St. Andrews), vol. 7, p. 96.

When Franklin and his son William set out for Scotland on August 8, 1759, the streets of London were filled with people celebrating the news that English and Hanoverian troops had routed the French in the victory at Minden.

Roads to Scotland were narrow clay lanes, impassable after rain. Bridges were precarious, inns wretched, relays uncertain, and highwaymen were everywhere.

Franklin's journey took him through Staffordshire, Derbyshire, Liverpool, and the Carlisle Road to Edinburgh. He passed through Birmingham, where he met with family relations and visited John Baskerville and Matthew Boulton.

As he progressed, Franklin became aware of the animosity between the Scots and English. He observed that from Lancaster Northward, every tavern window was covered with anti-Scots graffiti; and the same against the English, North of the border.

Auld Reekie: "Athens of the North"

When Benjamin Franklin arrived in Edinburgh in 1759, the population of the city was approximately 50,000 souls.

The Franklins found lodging on Milne Square. Philadelphia, at the time, had cesspools, but not Edinburgh. Apartments used "luggies" to hold human excrement, thrown out through windows onto the streets below at 10 p.m. each evening. The Edinburgh poet Robert Fergusson, one of Burns' beloved predecessors, wrote a famous verse about the "gardy loo":

On stair wi tub or pat in hand
The bare-foot housemaid loe to stand
That antrin folk may ken how snell
Auld Reekie will at morning smell.
Then with an inundation big as
The burn that 'neath the Nor Loch brig is
They kindly shower Edina's roses
To quicken and regale our noses.²¹

Franklin and William were elevated as Guild Brethren of Edinburgh in a public ceremony on September 5th. Adam Smith was in Edinburgh at the time, and had just published his *Theory of Moral Sentiments*. He met with the Franklins.

Sir Alexander Dick, President of the College of Physicians, was the first host of Franklin in Edinburgh; he became one of his associates and correspondents. He was to

²¹ Robert Fergusson's poem "Auld Reekie", *Poetical Works*, Glasgow, 1800.

further medical science in America. He took Franklin on a tour of the municipal hospital, many features of which Franklin later incorporated in the Pennsylvania Infirmary.

The road from Edinburgh to Glasgow was a muddy winding trail of 46 miles which took the Franklins 12 hours to travel. In the winter, the same trip could take a day and a half. On the northern horizon of the road, the surveyor's rods marked the site of the new Carron Iron Works, the fledgling industry which was to be closely linked to Franklin's designs for the industrialisation of the British Isles.

Glasgow then had 20,000 inhabitants. A thriving shipbuilding industry had started; boats laden with rum from Jamaica and tobacco from Virginia sailed into the Clyde.

The tavern where the Franklins lodged was crowded with Reverends of the Kirk of Scotland, there to attend the Synod of Glasgow and Ayr. The Synod opened a few days after Franklin's arrival, with a sermon entitled "Trial of Religious Truth by Its Moral Influence," delivered by the Moderator, a parson from the Laigh Kirk of Paisley, John Witherspoon, later to become President of the College of New Jersey at Princeton and member of the Continental Congress. Benjamin Franklin and Witherspoon would sit together in Philadelphia during the debates which proceeded the signing of the Declaration of Independence.

In Glasgow, Franklin met with Robert Simson, Professor of Mathematics at the University of Glasgow (with whom Franklin had earlier corresponded), and Professor John Anderson, who later guided the Americans through the Perthshire. Anderson was of a scientific turn. He was engaged in perfecting a new cannon, in which the recoil was counteracted by the condensation of air. It is also believed that Franklin assisted Professor Anderson to set up a lightning rod at the North College.

Franklin made a walking tour of the quad on High Street, by the University of Glasgow. He visited Alexander Wilson, the father of Scottish type founders who was about to take the Chair of Practical Astronomy at the University. Leaving Wilson's shop, he called upon the brothers Andrew and Robert Foulis, the celebrated printers. Like John Baskerville, they specialised in the classics; Franklin obtained a copy of the Foulis *Thucydides*. The two brothers also established a museum to display the works of Italian and French artists.

On the quad, one door removed from the Foulis workroom, laboured a frail, sickly young mechanic, who eked out a living by mending musical instruments, James Watt.

The Founding Father from St. Andrews

St. Andrews lay off the direct road from Perthshire to Edinburgh. The university faculty had conferred their honour upon Franklin in February 1759. In the meantime, he had forwarded the University his book, *Experiments and Observations*, which lies today in the college library. In a formal ceremony, Benjamin Franklin was made a Guild Brother of the town of St. Andrews.

Among the students who gathered on that October day in 1759 to witness the investiture was James Wilson of Fife. Wilson was also to sign the Declaration of Independence, and was to become one of the keenest legal minds of the new American Republic.

Later a member of the Committee of Detail of the Continental Congress, James Wilson was the principal author of the first draft of the U.S. Constitution. It was he who proposed that the executive branch of government be headed by a single person, to be styled "the President of the United States."

Wilson would also become the first Associate Justice of the Supreme Court of the United States; he taught natural law to President George Washington's cabinet. He helped Alexander Hamilton to found the National Bank of the United States.

During his stay in St. Andrews, Franklin saved the life of one of the students, then seriously ill, David Stuart Erskine, Lord Cardross, later Earl of Buchan. As a result, Erskine cultivated an enthusiasm for all things American. In June 1792, during Washington's first term, Lord Buchan sent the President, whom he considered his "cousin," a box made from the wood of an oak tree under which William Wallace is said to have rested after the battle of Falkirk. In his Will, Washington returned the object to its original owner.

The Earl of Buchan also became a friend of Robert Burns. It was the Earl who encouraged Burns to tour Scotland and develop his "Muse of Scottish story and Scottish scenes",²² shortly after Burns had decided against exile. In 1791, at the Earl's behest, Burns composed his *Address to the Shade of Thomson*, the recently deceased poet.

As a result of Franklin's first tour of Scotland, he advised American medical students to attend the University of Edinburgh.

In the spring of 1760, Franklin persuaded John Morgan to study at Edinburgh rather than Leyden, which had hitherto been the prime choice of American and English medical students. Morgan later became the founder of the medical school of the University of Pennsylvania. Franklin personally sponsored a number of medical students to study at Edinburgh. Many showed their gratitude by dedicating their graduation thesis to him.

During October 1766, two lads from America arrived in London and urged Franklin to sponsor their entry into Edinburgh University. They were Jonathan Potts, son of the founder of Pottstown, Pennsylvania, and Benjamin Rush. Franklin finally arranged through Principal William Robertson that the two should stay with Dr. Thomas Blacklock. Rush wrote in his autobiography: "At that time I adopted republican principles in the city of Edinburgh."²³

²² Letter to the Earl of Buchan from Robert Burns, February 7, 1787 (*Collected Letters of Robert Burns*, edited by Dr. James A. Mackay; pp. 266-267). Burns had sent the Earl several of his poems containing republican themes, such as the *Ballad of the American War* and *Bruce's Address at Bannockburn (Scots Wha Hae)*; see Burns' letter to the Earl of Buchan, January 12, 1794.

²³ Benjamin Rush, *The Autobiography of Benjamin Rush*, Princeton University Press, 1948; p. 115.

Benjamin Rush completed his studies at Edinburgh and went to London where he lived with Franklin at Craven Street. Rush was to become one of the signers of the Declaration of Independence; he became director of the U.S. Mint in 1797. Rush also befriended Thomas Paine, during Paine's stay in Philadelphia in 1774. According to Rush, it was his idea to have Paine write *Common Sense* and also he who gave the book its title.²⁴ The book was then published by a Glasgow bookseller settled in Philadelphia, Robert Bell. This book was the spark which touched off popular support for independence among the colonialists.

When the Revolution broke out, all the American graduates of Edinburgh University, except one, enlisted in the patriot army!

Vulcan's Scottish Forge

"We were conducted to the works for melting ore; where four furnaces, of forty-five feet in height, devoured both night and day enormous masses of coals and metals...one doubts whether he is not at the foot of a volcano in eruption, or whether he has been transported by some magic spell to the brink of the cavern, where Vulcan and his Cyclops are busy forging thunderbolts."²⁵

This was the observation made by the French scientist Faujas de St. Fond, upon his visit to the Carron Iron Works outside of Falkirk, Scotland in 1784.

Those iron works were the result of the Franklin industrialisation project, overlapping the projects at Birmingham and Manchester. The Carron Iron Works became "the largest and most famous producer of iron and all kinds of iron goods in Europe before the end of the eighteenth century."²⁶

In 1771, Benjamin Franklin returned to Scotland, following a short excursion to Ireland, of which he once wrote:

"All Ireland is strongly in favour of the American cause. They have reason to sympathize with us. I send you four pamphlets written in Ireland or by Irish gentlemen, in which you will find some excellent well-said things."²⁷

²⁴ Ibid., pp. 113-114.

²⁵ Faujas de St. Fond, *Travels in England and Scotland, 1784*, edited by Sir Arch, Geikie, 1907; vol I, pp. 177-186.

²⁶ H.M. Cadell, *The Story of the Forth*, James Maclehose and Sons, Glasgow, 1913; p. 183.

²⁷ Benjamin Franklin's letter to Samuel Cooper, April 27, 1769. There were four Irish-born signers of the U.S. Constitution: Pierce Butler, Thomas Fitzsimons, James McHenry, and William Paterson.

En route to Glasgow, during 1771, Franklin's party turned northward near Falkirk. Franklin's immediate interest was a new canal being constructed under the supervision of his friend and correspondent, John Smeaton of Leeds. Smeaton had built the Eddystone lighthouse on the islet of Eddystone in Plymouth Harbor. The Forth Canal was his next project. Joining Franklin on the journey was Henry Merchant, Agent for Rhode Island, later a member of the Committee of Correspondence in Rhode Island and a delegate to the Continental Congress. Merchant described in his journal what the party saw:

"Novr. 6 - ...Just beyond Falkirk we crossed the famous Canal now cutting from the Forth which leads from the open Sea at the East of Scotland by Forth & Edinburgh to Stirling &c- This Canal begins near the most noted Iron Works and leads to the River Clyde which from the open Sea the West Side of Scotland up to Genoch the Seaport for & near to Glasgow. So that a Communication will be formed from Sea to Sea by this Canal when finished...Crossing at the Head of the Works we got out of the Chaise & examined it for some Distance then went six or seven Locks or gates for letting in & shutting out the Water the Ground being here uneven. And at this place the Road is to run under the Canal."

James Watt tells us that he was engaged in the survey of the Forth and Clyde canal and "leading a life of much vexation and bodily fatigue, of hunger, cold and wet feet."²⁸ During this time Watt was also acting as engineering advisor of the Carron Works. He was there working on the steam engine project with Dr. John Roebuck. Some of the parts for his steam engine were being cast at Carron.

Dr. John Roebuck, one the founders of the Carron Iron Works, settled in Prestonpans in 1749. He applied his knowledge of chemistry to the manufacture of sulphuric acid, and undertook a partnership with Franklin's collaborator, Samuel Garbett, to use his invention for making the acid in leaden chambers, a process continued into the 20th century. Faujas de St. Fonds reported that Prestonpans was the greatest manufacturer of sulphuric acid in Great Britain at that date (1784). The entire process was kept secret; the works surrounded by high walls, past which no stranger was allowed.

Alongside William Cadell, an iron and timber merchant interested in the development of domestic iron production, Roebuck and Garbett organised what became the Carron Iron Works. The choice of site, one with water power, access to the sea, etc. was studied during the spring and summer of 1759.

One of the obstacles, given the animosity against the English, was the lack of skilled masons and furnacemen in Scotland. Workers from England had to be imported on the sly. In January 1760, the first air furnace in Scotland was "blown in" at Carron.

²⁸ James Watt's letter to Dr. William Small, December 24, 1771.

Nailers, and other craftsmen were also brought in to train the Scots. By 1770, Carron Company had nailers working at Carron, Camelon, St. Ninians, Kilsyth, Cramond, and Kirkcaldy. This proved to be a profitable cottage industry for a large number of poor families.

In 1767, as a result of a severe drought which stopped production for three months, a steam engine was built to raise and recycle the spent water. James Watt's first high-pressure steam engine was also used for winding coal in the Kinneil Colliery.

On November 15, 1771, Benjamin Franklin and his party arrived at the Carron Iron Works. The invitation for the visit had come from Samuel Garbett and his son-in-law Charles Gascoigne²⁹, also a partner in the iron works. In 1760, the infant forge had timidly advertised its production of "Dr. Franklin's Pennsylvania stoves," and was now a flourishing industry.

One of the specialty products manufactured at the Carron Works were cannon. The ordnance which Franklin and Merchant saw being cast at the Carron Works was to be employed later by their own countrymen against the British Empire. For when the neophyte American navy came into being four years later, the ships which went out from Boston, New Bedford and Philadelphia, under Nick Biddle, Jack Barry, and John Paul Jones, were equipped with *Carronades*, light naval cannons, also called "smashers", cast at the Carron foundry. The Carronade was the invention of Patrick Miller, a self-made man who had started out as a sailor and eventually became a Senator of the College of Justice, Director and later Deputy-Governor of the Bank of Scotland, and a director of the Carron Iron Works. Another of the partners at the Carron Works, Samuel Shrapnel, gave his name to the explosive shell still in use today.

During the American War of Independence, in 1777, nearly 2,000 men were employed at the Carron Iron Works. The economic impact of the works was considerable:

"The erection of this work hath quite altered the face of the country around it. Besides the numerous buildings raised for carrying on the manufacture, in a spot where formerly there was not a single house, several villages have been erected for the convenience of the workmen. The

²⁹ As a boy, Charles Gascoigne was taken into the family of Samuel Garbett. Both Garbett and Gascoigne were eventually run out of Scotland "by creditors." Gascoigne fled to Russia with his skilled workmen and the Carron secrets for ordnance fabrication; her government had purchased many of Carron's cannons. He obtained an agreement by Czarina Catherine II to build a large cannon foundry at Petrozavodsky. Gascoigne was made a Knight of the Order of St. Vladimir and given the rank of General in the Russian Army and Councillor to the Empress. One of this Scottish workmen, Charles Baird, established the iron works at Kronstadt for the manufacture of guns, steam engines, etc. It should be noted that John Paul Jones, after the American Revolution, was assigned by the U.S. government to serve under a Russian commission issued by Catherine the Great, as Rear Admiral in the Russian fleet in the Black Sea, in the Russia war against the Turks. Gascoigne may have associated with Jones during that period.

neighbouring fields have been enclosed and improven, many spots, which were formerly quite barren, have been cultivated, and turned to good account;"³⁰

In 1787, Robert Burns attempted to tour the Carron Iron Works on a Sunday, when the plant was closed. The caretaker refused to admit Burns and his friend William Nicol. Disappointed, the Bard retired to an inn across the road and inscribed the following epigram into one of the windows of the inn:

We cam na here to view your warks,
 In hopes to be mair wise,
 But only, lest we gang to hell,
 It may be nae surprise:
 But when we tir'l at your door
 Your porter dought na hear us;
 Sae may, shou'd we to Hell's yetts come,
 Your billy Satan sair us!

That same year, Burns had the Edinburgh edition of his poems published. William Cadell, co-founder and owner of the Carron Company, was a subscriber.

Steam navigation had its beginnings at Carron. Patrick Miller, the inventor of the Carronade, had a small model steamer with 4-inch cylinders constructed there in 1788. Miller then financed the first full-sized steamship built in the British Isles, constructed and designed by William Symington and launched on the Carron River in 1789. By 1802, Symington had built and launched the *Charlotte Dundas*, a steam-powered tug designed for canal work. Robert Fulton, an American who had seen the *Charlotte Dundas* in 1802, brought a Boulton and Watt steam engine back to America and had it installed in a passenger boat which ran a 150 mile service between Albany and New York City. From that time, Scotland led the world in the construction of the best marine steam engines, and by 1860 the Clyde shipyards were the largest in the British Isles.

Patrick Miller played an important role in the life of Robert Burns. He first met Burns during the poet's trip to Edinburgh in 1786. Within weeks of their meeting, Burns accepted an offer from his new "generous friend" to lease a farm on Miller's estate near the town of Dumfries. He also provided Burns with a loan to build a farmhouse and fencing. Miller had made scientific experiments in agriculture. He invented a drill plough and a new type of threshing machine. It was he who first feed steamed potatoes to cattle.

³⁰ Nimmo, *History of Stirlingshire*, 1st edition.

The philosophy behind Benjamin Franklin's school of industrialisation appears to have carried on at the Carron Works; in September 1829, the following article about the works appeared in the London *Morning Herald*:

"The Company 'grow' their own workers, as an extensive manufacturer has it, and hence their hands are completely masters of their several departments. They pay no attention to the fluctuations of the markets and the currency; hard as the times are, they have never mentioned a reduction of the wages, they have more humanity and sagacity than to attempt to extract the last drop of sweat from the poor workmen, and reduce them to the last ounce of oatmeal; and consequently, all who are so fortunate as to be in their employment are comfortable and contented, and take a conscientious interest in the welfare of the concern."



Francis Egerton, Third Duke of Bridgewater
1736-1803

The Duke of Bridgewater, working with Franklin's collaborators, built the first modern canal in England. The canal is depicted in the drawing on the left, showing the canal full of barges traversing a natural waterway.

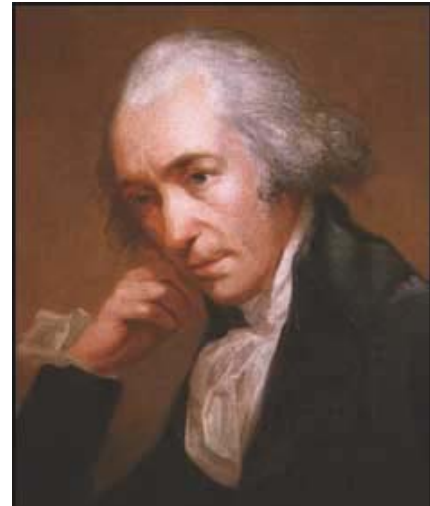

James Watt
1736-1816

Worked with Benjamin Franklin in perfecting the first efficient steam engine (diagram below), and was a leading figure in the Industrial Revolution.

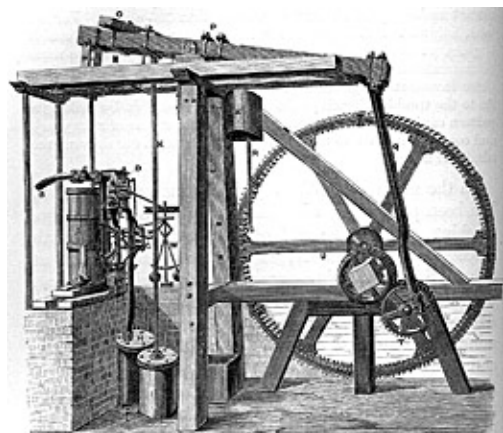



Benjamin Franklin
(1706-1790)

Founder of the industrial revolution, who organised the international support which resulted in the success of the American War of Independence and the establishment of the first true republic in history.



Gottfried Wilhelm Leibniz
(1646-1716)

As a scientist and leader of the international republican movement, he played a decisive role in creating the foundation of the American Republic.



Alexander Spotswood
(1676-1740)

Governor of Virginia, 1710-1722. Founder of the republican faction which produced George Washington



Alexander Hamilton
(1757-1804)

First Secretary of the U.S. Treasury and chief architect of the American System of economics.



David Hume
(1711-1776)



Adam Smith
(1723-1790)



Jeremy Bentham
(1748-1832)



Friedrich Schiller
(1759-1805)



Robert Burns



John Paul Jones

*Scottish-born hero of the American Revolution.
(Library of Congress)*



James Wilson : *signer of the Declaration of Independence and U.S. Constitution, he played a critical role in framing the Constitution and became a Justice of the Supreme Court.*

(Independence National Historical Park, Philadelphia, Pennsylvania)

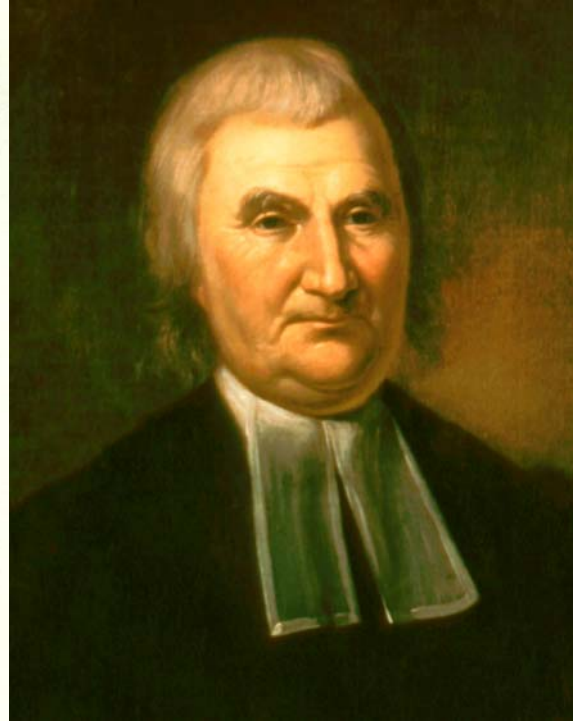

Rev. John Witherspoon

From Paisley, he was recruited by Franklin; became President of Princeton College and signer of the Declaration of Independence.

(Independence National Historic Park, Philadelphia)

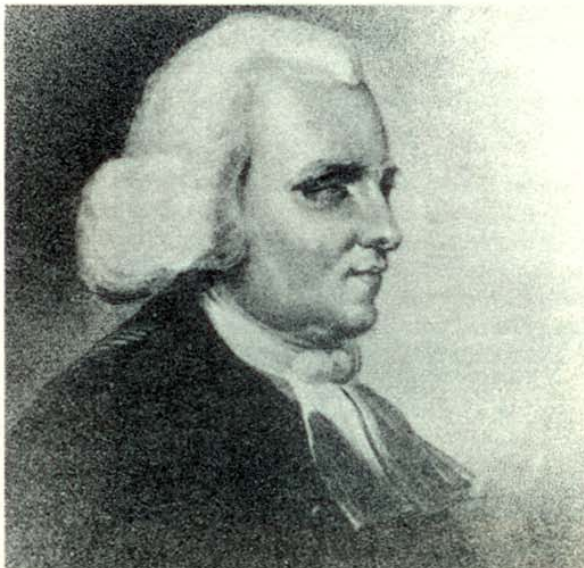

Dr. Thomas Blacklock

1721-1791

The blind scholar of Edinburgh was a friend of Benjamin Franklin and Robert Burns.

(National Library of Scotland)

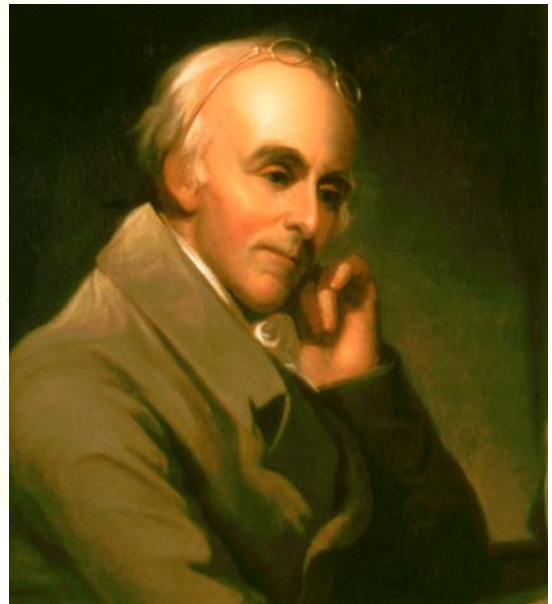

Dr. Benjamin Rush

American medical student who “adopted republican principles” while boarding at Dr. Blacklock’s home; signer of the Declaration of Independence.

(Independence National Historic Park, Philadelphia)

V. THE "HEAVEN-TAUGHT PLOUGHMAN"

Is there no daring Bard will rise and tell
How glorious Wallace stood, how -- hapless fell?
Is there nae poet, burning keen for fame,
Will try to gie us sangs and plays at hame?

- Robert Burns
Scots Prologue for Mr. Sutherland

Thirteen years after the battle of Culloden (1746), while Britain was at war with France, Robert Burns was born to a poor tenant farmer, in the town of Alloway in Ayrshire.

Burns' formal education was limited. In his early youth he developed a thirst for what he called "bookish knowledge." As he notes in his autobiography, the first two books he ever read (borrowed from the local blacksmith) made a life-long impression on him: *The Life of Hannibal* and *The History of Sir William Wallace*. They instilled in the youth a spirit of Scottish nationalism and the soul of the soldier who lives to fight tyranny. He also notes the influence of Shakespeare and other English poets. In his late twenties, Burns obtained a pocket edition of "Milton, which I carry perpetually about with me."

When not labouring in the fields, Burns studied Scotland's poets. In particular, he cites, as his predecessors, Allan Ramsey (1685-1758) and Robert Fergusson, who died in 1774 at the age of twenty-five. It is from the literary tributaries of Fergusson's vivacity and humor that Burns' style flows. It is also Fergusson, whom we can credit with originating what has become known as the "Burns Stanza" (six lines rhyming A, A, A, B, A, B; with the A lines having four heavy stresses and the B only two). This is exemplified in the following passage from Burns' *To a Mouse, On Turning Her Up in Her Nest With the Plough, Nov. 1785*, which is also inspired by Fergusson's poem, *On Seeing a Butterfly in the Street*:

Wee, sleekit, cowrin, tim'rous beastie,
O, what a panic's in thy breastie!
Thou need na start awa sae hasty,
Wi' bickerin brattle!
I wad be laith to rin an' chase thee,
Wi' murd'ring pattle!...

But, Mousie, thou art no thy lane
In proving foresight may be vain:
The best-laid schemes o' Mice an' Men
Gang aft agley,

An' lea'e us nought but grief an' pain,
For promised joy!

Still thou are blest, compar'd wi' me!
The present only toucheth thee:
But, Och! I backward cast my e'e
On prospects drear!
An' forward, tho' I canna see,
I guess an' fear!

In 1786, Burns had his first volume of collected poems published in a limited amount, known as the "Kilmarnock edition." Benjamin Franklin's friend, Dr. Thomas Blacklock, who intervened to prevent Burns from leaving Scotland, was the elderly leading cultural light of Edinburgh. Though blind, he was a poet, a skilled musician and a Doctor of Divinity.

Upon the invitation of Blacklock, Burns travelled to Edinburgh in 1786. There, observed Dr. Currie, "Blacklock received him with all the ardour of affectionate admiration; he eagerly introduced him to the respectable circle of his friends; he consulted his interest; he emblazoned his fame; he lavished upon him all the kindness of a generous and feeling heart, into which nothing selfish or envious ever found admittance." Later, Blacklock contributed songs to Burns' *The Scots Musical Museum* of Scottish songs, and just before Burns' death attempted to publish a periodical with him.

It was undoubtedly Blacklock who first introduced Robert Burns to Henry Mackenzie, who had written a glowing review of Burns' first edition of poems in the December issue of his literary periodical *The Lounger* (from which originated the label which Burns received of the "heaven-taught ploughman"). Mackenzie drafted the terms of agreement between Burns and the Edinburgh publisher William Creech for the second edition of Burns' works, at a meeting between the three at Mackenzie's home in April of 1787.³¹ It was also Henry Mackenzie who, one year later, first introduced the work of Friedrich Schiller to the people of the British Isles, in an address to the Royal Society of Edinburgh which reviewed his drama *The Robbers*. That address sparked a series of positive reviews of Schiller in British periodicals, including Edward Ash's short-lived, London-based *The Speculator* (1790) which was a propaganda vehicle for Schiller's works.

During his stay in Edinburgh, Burns arranged to become an Exciseman. After touring the Highlands and spending the winter in Edinburgh, he returned to the countryside in Ellisland to marry, farm, and write poetry.

³¹ James Mackay, *Burns, A Biography of Robert Burns*, Mainstream Publishing, Edinburgh, 1992; p. 294.

Robert Burns was no chauvinistic advocate of the Jacobite cause, as some historians have portrayed him, but a strong supporter of the American War of Independence.

The so-called "Jacobite" songs of Burns, which he seems to have begun writing in earnest at the start of the French Revolution in 1789 were, for the most part, scathing polemics against the short-sighted, often violent, actions of the Jacobites. His song, *The Battle of Sherramuir*, lampoons both the English and Scots who fought in the 1715 uprising.

Burns' song *Ballad on the American War* shows the poet had detailed knowledge of the personalities, issues, and military engagements of the American Revolutionary War. His enthusiasm for the Revolution is told in the *Ode for General Washington's Birthday*, in which he puts himself forward as the bard of America's cause:

No Spartan tube, no Attic shell,
 No lyre Aeolian I awake;
 Tis liberty's bold note I swell,
 Thy harp, Columbia, let me take!
 See gathering thousands, while I sing,
 A broken chain exulting bring,
 And dash it in a tyrant's face,
 And dare him to his very beard,
 And tell him he no more is fear'd -
 No more the despot of Columbia's race!
 A tyrant's proudest insults brav'd,
 They shout – a People freed! They hail
 an Empire sav'd.

In this tribute, written not in Scots but English – it was clearly intended to be read in America – there is an appeal to prevent "the generous English name" from being linked with such "damned deeds of everlasting shame!" Burns believed that the American Revolution would force the English Crown to bend to rule by Reason. But the poet's strongest polemics were reserved for his fellow Scots.

Scotland and the Revolution

With the success of the American Revolution, republicanism spread across Europe. In 1791, the first English-language edition printed in Europe, of the first part of Thomas Paine's *The Rights of Man*, sold over one million copies in the British Isles.³² It

³² An Englishman, Thomas Paine, like Burns, had been an Excisemen in Yorkshire. In 1774, he moved to America to organise for independence.

was even translated into Scots-Gaelic. The following year, the pro-republican Society of Friends of the People was founded by a Scot in London; local chapters began to spring up across the land. One of the chief organisers was a young Glasgow barrister, Thomas Muir.

However, the aristocratic families of Europe were not about to surrender to the Age of Reason. Burns, like Schiller in Germany, fell prey to the sedition laws. During the American Revolutionary War, and then during the war with France in 1793, the Habeas Corpus Act was suspended in Scotland, opening the door to sedition trials.

After the second part of Paine's *Rights of Man*, appeared in Great Britain in May of 1792, the government banned "seditious" meetings and publications, and more especially, Paine's book.

On June 4th of that year, the celebration of the King's birthday was marred by protests throughout Scotland. Hungry crowds in Edinburgh burnt the effigy Henry Dundas, Lord Advocate of Scotland. Troops were ordered to fire on the crowd.

By December 11th, the First Convention of the Scottish Friends of the People opened in Edinburgh; 150 delegates represented 80 societies from 35 towns and villages. The conference drafted a petition to the British Parliament demanding electoral reform. On the evening of the last day of the convention, it was suggested that the delegates arm themselves in order to help local magistrates suppress any riots which might occur as a result of the popular support for the reform petition. On January 1st, Thomas Muir was arrested and charged with circulating Paine's *Rights of Man*, making seditious speeches, and reading and defending the Address from the United Irishmen to the convention.

Muir was arrested while en route to the sedition trial of James Tytler, a friend of Robert Burns known as "Balloon" Tytler; he had made the first balloon flights in Great Britain in 1784. Tytler was arrested for publishing the handbill advertising the convention of the Friends of the People.

On his way to stand trial in Edinburgh, Thomas Muir, in chains, passed through the village of Gatehouse. Burns was there that day.

During the Muir trial, the evidence of the defendant's twenty-one witnesses was dismissed by Scotland's hanging judge, Lord Braxfield, who sentenced Muir to be exiled to the penal colony of Botony Bay in Australia for fourteen years. Given the conditions of confinement and transportation, the sentence was a virtual death sentence. Braxfield's summary states that "a government in every country should be like a corporation" (e.g. the British East India Company), and reads in part:

"The British Constitution is the best that ever was since the creation of the world and it is not possible to make it better. For is not every man secure? Does not every man reap the fruits of his own industry and sit under his own fig-tree?

"What right has such a rabble to representation? In this country the Government is made up of the landed interest which alone has a right to be

represented. As for the rabble, who have nothing but personal property, what security has the nation for the payment of their taxes. They may pack up all their property on their backs and leave the country in the twinkling of an eye, but landed property can not be removed."³³

The incident prompted Burns to write the song *Scots Wha Hae*, in protest. Though the song was banned as seditious, it would become Scotland's true national anthem:

By Oppression's woes and pains!
By your Son's in servile chains!
We will drain our dearest veins,
But they shall be free!

Lay the proud Usurpers low
Tyrants fall in every foe!
LIBERTY'S in every blow!
Let us Do -- or Die!!!

As Burns reported, that anthem was inspired by "the glowing ideas of some other struggles, not quite so ancient."

Charged With Seditious

It was at that time that Robert Burns was officially investigated for seditious. Burns had been allowed some latitude by the authorities, because by the 1790's he was acknowledged to be the national poet. At one convivial event, after a toast to Prime Minister William Pitt was drunk, Burns proposed "a bumper to the health of a much better man -- George Washington!" This outspokenness led to a challenge to a duel, forced upon him by an offended English officer. Fortunately, the duel never took occurred.

As oppression intensified, Burns assumed the role of "loyal opponent" to the British Crown. That role, however, became more uneasy as the crisis provoked by the French Revolution erupted in 1789.

By 1793, pro-republican clubs began to be outlawed, including the Society of Friends, which had a chapter in Dumfries, where Burns was then living. During the trial

³³ P. Mackenzie, *Life of Thomas Muir*, pp. 107-108, 1831.

of Thomas Muir, Burns hid his copies of Paine's books in the house of George Haugh, the Dumfries tinsmith.³⁴

Burns' republican activities, however, were not purely literary. In 1792, in his capacity as Exciseman, he led a contingent of Royal dragoons against a smuggler's ship, an incident immortalised in a song he wrote while waiting for the dragoons to arrive, entitled *The Deil's Awa*. The four small cannons (Carronades) from the captured ship, which he sent on to the French Assembly, never reached their destination. A royalist spy in the Scottish Excise, shortly afterwards, denounced Burns as unpatriotic. On January 10, 1793 a formal investigation on charges for sedition was initiated against him by the Excise Board. The poet replied, "As to France, I was her enthusiastic votary in the beginning of the business -- When she came to show her old avidity for conquest...I altered my sentiments." The investigation of Burns was dropped.

As the Jacobin mobs terrorised France, Burns became in 1795 one of the founders of a local militia, the Royal Dumfries Volunteers. Though ill, he joined and drilled with his regiment, against the threat of a possible French invasion.

These actions by Burns were not a betrayal of his earlier political allegiance. He opposed tyranny, in whatever guise.

³⁴ Mackay, p. 541

VI. "WE'RE BOUGHT AND SOLD FOR ENGLISH GOLD"

What force or guile could not subdue
Thro many warlike ages
Is wrought now by a coward few
For hirling traitor's wages.
The English steel we could disdain,
Secure in valour's station;
But English gold has been our bane -
Such a pacel of rogues in a nation!

- Robert Burns
Such a Parcel of Rogues in a Nation

Following the Battle of Culloden in 1746, the English forced tens of thousands of Scots to emigrate; dissidents were transported, and entire villages displaced. The clans' chiefs lost most of their privileges. The disappearance of the feudal aspects of the Highland clans, however, was not replaced with anything better. The object was to "pacify" Scotland, so that it would not again pose a threat to the Crown. The war was waged not only against Scotland, but against America and continental Europe.

After the British surrender at Yorktown, the man who negotiated the peace settlement, William Petty, Second Earl of Shelburne, staged a virtual coup d'etat in 1783. There came to power the political faction behind the opium trade, the so-called "Venetian Party" radicals.³⁵ Thereby, William Pitt the Younger became Prime Minister for 20 years. Pitt's first major piece of legislation was the 1784 East India Bill, which made the East India Company in effect a department of the British government, under a Board of Control. Henry Dundas, the infamous Scottish "Quisling," became Pitt's Secretary of State and directed the Board of Control. In 1787, he conceived a plan to extend the opium trade into China. This Dundas, a patron of Adam Smith, was the uncle of Robert Dundas, the hated Lord Advocate of Scotland, whose *clearances* of the Scottish Highland population inspired the phrase "sheep eat men."³⁶

Under his "Venetian dogeship," as Benjamin Disraeli put it, Shelburne set up a vast intelligence operation to crush America and the Lafayette Party in France. Disraeli wrote the following about Shelburne:

³⁵ It was Shelburne who included the Free Trade clause in the Peace Treaty negotiated with the United States government, when the War of Independence ended. Shelburne's scheme to bankrupt and re-absorb North America into the British Empire, by unbridled Free Trade, nearly destroyed the American Republic in its cradle. But thanks most especially to Alexander Hamilton among others, the Free Trade policy was overturned.

³⁶ A Scottish mafia headed by the intermarried Scots-Dutch Hope and Baring families took over the opium trade; Jardine, Matheson, Keswick, and Hutchinson were in this grouping.

"He maintained the most extensive private correspondence of any public man of his time...The earliest and most authentic information reached him from all courts and quarters of Europe; and it was a common phrase, that the minister of the day sent to him often for the important information which the cabinet itself could not command."³⁷

The leading figures of late Eighteenth-Century British Philosophical Radicalism were all lackeys to Lord Shelburne; Adam Smith the economist, Jeremy Bentham the first head of the Secret Intelligence Service, Edward Gibbon the historian, and Thomas Malthus. With the exception of Gibbon, they were all plagiarists of a defrocked, Venetian monk named Giammaria Ortes (1713-1790). In turn, there is nothing in the work of the Nineteenth-Century liberals, such as James Mill, John Stuart Mill, Charles Darwin, Williams Jevon, Thomas Huxley, or John Ruskin which was not derived directly either from those Shelburne lackeys, or from members of Venice's intelligence services, such as Ortes.

David Hume

Edinburgh, its University and its intellectual salons, was a centre for the efforts to erase the ideas of the American Revolution. The chief agent for these operations was David Hume, whose services had been purchased by Lord Shelburne. Shelburne had sent Smith and Hume to France for Jesuit training; they were then put on retainer to spin the "theory" of Free Trade.

Hume spent ten years in France, including from 1766 to 1767, as the official envoy of British Foreign Minister Shelburne. While there, his patron was the Grand Prior of the Order of St. John, the Prince de Bourbon Conti. Bourbon-Conti's personal librarian, the Abbé Blavet, popularised Hume's writings in France and wrote the first French translation of the *Wealth of Nations*.

David Hume had his first book, *Human Understanding* published in 1734. It was a report on Jesuit methods of mind control. He reported that no matter how absurd, "miracles" can be sold to the suckers. On his return to Scotland, he set out to prove the axioms in his book, by enlisting Adam Smith, a fellow Professor of Moral Sciences at the University of Edinburgh and "dearest friend," in the literary hoax of the century, the *Ossian* epic, a forged tale of pagan, Celtic greatness which allegedly occurred in the Scottish isles 2,000 years ago. James Macpherson, an obscure minister, was recruited

³⁷ Disraeli maintained that Shelburne was the most important and least appreciated figure in eighteenth-century English politics. He represents Shelburne fictionally in his novel *Sybil*.

to claim that he had found these tales from Gaelic fragments preserved in Scotland's Western Isles. The project was promoted and financed by the highest levels of the British oligarchy, resulting in the publication of the first English collection of the *Poem of Ossian* in 1764. Michael Denis, a Jesuit, working in Vienna, produced the first German edition of *Ossian*, which duped Herder and Goethe among others. The Ossian myths were designed to launch an irrational ideology known as the Romantic Movement. James Macpherson was also the author of the official 1776 response of the British Empire to the U.S. Declaration of Independence.³⁸

On his deathbed, David Hume had a good laugh at those he had duped, and confessed to the charade.³⁹

For Hume, there is really no human self, but merely a bundle of changing perceptions. In his *Enquiry Concerning Human Understanding*, Hume claims there to be no necessary connection between a cause and an effect that the human mind can know with certainty; but only a vague association or habit of thought that one phenomenon has been usually followed by another. In these earlier works, however, Hume still accepted the idea of filling the "tabula rasa" of each human mind with received ideas of conduct, held to be morals or custom, including religion – his modern "ethics."

But as the Shelburne faction became dominant in Great Britain, Hume's skepticism became far more radical. In his *Dialogues Concerning Natural Religion*, he repudiates the notion of customs and morality in favour of unbridled hedonism.

Hume died in 1776. Just before his death, however, Hume had begun to attack Benjamin Franklin. In 1774 letter to Adam Smith, he wrote:

"Pray, what strange Accounts are these we hear of Franklin's Conduct? I am very slow in believing that he has been guilty in the extreme Degree that is pretended; tho' I always knew him to be a very factious man, and Faction next to Fanaticism, is, of all passions, the most destructive of Morality."⁴⁰

³⁸ Though the authorship of the pamphlet, entitled *The Rights of Great Britain Asserted Against the Claims of America, Being an Answer to the Declaration of Independence*, was kept anonymous at the time of publication, Lord North later admitted that it was the product of James Macpherson, in a letter sent to King George III upon his leaving office in 1782. For more on this subject, see the unpublished manuscript [The Ossian Poems: James Macpherson & the Romantic Movement – British Cultural Warfare Versus the Nation State](#), by Mark Calney.

³⁹ David Hume, *Philosophical Works*. T.H. Green and T.H. Grose, editors, Scientia Verlag Aalen, Berlin, 1964; vol. IV, p. 415.

⁴⁰ David Hume, *The Letters of David Hume*, Clarendon Press, Oxford, 1932; vol. II, p. 286. Hume's refers to the fact that the Privy Council on January 29, 1774, accused Franklin of having used underhand means to obtain certain letters relating to public affairs. These he transmitted to Boston; on the strength of which, the Massachusetts Assembly petitioned the King to remove the Governor and Lt. Governor. Solicitor-General, Alexander Wedderburn, furiously attacked Franklin, who lost his position as Deputy Postmaster-General of the Colonies. This undermined any attempts at reconciliation between the American colonies and London. Franklin had been a correspondent of Hume's, and his houseguest during the visit to Edinburgh in 1771.

After the Ossian project, Hume's next great hoax was the promotion of Adam Smith's *The Wealth of Nations*.

Adam Smith

In his 1739 *Treatise of Human Nature*, Hume claimed that thought can be reduced to a mechanistic arrangement of sense impressions, and denied any lawfulness to the created universe. Twenty years later, Adam Smith, in his *Theory of Moral Sentiments*, also asserts that Man is an irrational animal, lacking the divine power of creative reason and love:

"The administration of the great system of the universe...the care of universal happiness of all rational and sensible beings, is the business of God and not of man. To man is allotted a much humbler department, but one much more suitable to the weakness of his powers, and the narrowness of his comprehension; the care of his own happiness, of that of his family, his friends, his country...But though we are endowed with a very strong desire of these ends, it has been intrusted to the slow and uncertain determinations of our reason to find the proper means of bringing them about. Nature has directed us to the greater part of these by original and immediate instincts: Hunger, thirst, the passions which unites the two sexes, the love of pleasure, and the dread of pain, prompts us to apply those means for their own sake, and without any consideration of their tendency to those beneficent ends which the great Director of Nature intended to produce by them."

In the same year that the American colonies issued the Declaration of Independence, 1776, Smith's book *The Wealth of Nations* was published to attack the emerging American republic. Lord Shelburne, who had commissioned the book from Smith in 1763, was concerned to counter the growing influence Benjamin Franklin economics and later, that of Alexander Hamilton.

Much of Smith's economic theories were plagiarised from a work by French physiocrat Turgot, *Reflections*. But his real mentor as one sees in the *Theory of Moral Sentiments*, was Giammaria Ortes. Wealth, to Smith, is merely the sum of the nominal monetary value of the "Bounty of Nature" plus the "value added" to anything else that could be bought and sold. It follows from such utilitarian logic, that the source of all wealth flows from man's proclivity to "buy cheap and sell dear." Smith's *Wealth of Nations* demanded that the American colonies be kept as producers of raw materials,

and that no manufacturing be allowed. The "raw material" he suggested be grown in the Carolinas was opium! He concludes the book by calling for £15.9 million taxes to be levied on the American colonies.

The usurious "taxation without representation" measures imposed on the colonies, such as the notorious Stamp Act of 1764, had been drafted by the Exchequer of the Bank of England, Charles "Champagne Charlie" Townsend. Adam Smith was the tutor of his stepson, the Duke of Buccleugh.

Today, many prominent Americans praise Adam Smith's Free Trade principles as though they were the keystone of the Republic. The truth is, that the American Revolution was fought *against* the policies of Adam Smith. Any Scot who might believe that Smith is a Scottish hero, should consider the following passage from *The Wealth of Nations*, where Smith argues for Ireland to join the Union:

"By the union with England, the middling and inferior ranks of people in Scotland gained a complete deliverance from the power of an aristocracy which had always before oppressed them."⁴¹

The freedom of Smith is the "freedom" of the slave to choose the yoke of a new "benevolent" master.

Smith incorporated the central theme of Giamaria Ortes which was to ignore technological change and the impact that this might have on, for example, agricultural production, or infant mortality and life expectancy. So, too, Malthus' famous 1798 essay *On Population*, plagiarised from Ortes' 1790 publication *Riflessioni sulla popolazione delle nazioni* (*Reflections on the Population of Nations in Respect to National Economy*). These arguments were used by Shelburne's Party to abolish the Poor Laws and justify the mass murder perpetuated by the East India Company in its colonies.⁴² These are the same arguments of "over population" and "limited resources" advanced by Prince Philip and his Worldwide Fund for Nature, the United Nations Organization, and the International Monetary Fund to justify genocide, against the underdeveloped nations.

⁴¹ Adam Smith, *The Wealth of Nations*, Arlington House; 1966, vol. II, p. 568.

⁴² "Instead of recommending cleanliness to the poor, we should encourage contrary habits. In our towns we should make the streets narrower, crowd more people into the houses, and court the return of the plague. In the country, we should build our villages near stagnant pools, and particularly encourage settlement in all marshy and unwholesome situations. But above all we should reprobate specific remedies for ravaging diseases; and restrain those benevolent, but much mistaken men, who have thought they are doing a service to mankind by protecting schemes for the total extirpation of particular disorders." -- Thomas Malthus, *An Essay on the Principle of Population*.

Jeremy Bentham

In October of 1776, a 28-year-old English barrister named Jeremy Bentham wrote contemptuously of the American Declaration of Independence:

"This they 'hold to be' a 'truth self-evident.' At the same time, to secure these rights they are satisfied that government should be instituted. They see not...that nothing that was ever called government ever was or ever could be exercised but at the expense of one or another of those rights, that...some one or other of those pretended unalienable rights is alienated...In these tenets they have outdone the extravagance of all former fanatics."

During the 1780s and 1790s, Lord Shelburne's leading Secret Intelligence Service operative, Jeremy Bentham, was hard at work to wreck France and regain the American colonies.

In 1782, Bentham moved into Shelburne's house, acting as his personal secretary and librarian. From there, he directed the activities of the French revolutionists Danton and Marat.⁴³

The link between Scotland and the Orleans family and the French branch of the Order of St. John, dates back to the turn of the eighteenth-century, when the Scottish Jacobites, who opposed the 1688 "Glorious Revolution" against the Stuarts, settled in France. Their spokesman in England, Lord Bolingbroke, also fled to France after he was accused of supporting the 1715 Highlands uprising, and spent the remainder of his life under Orleans sponsorship. Shelburne used those circles, notably his Jacobite father-in-law John Carteret.

Through Shelburne, Bentham met Mirabeau, son of the physiocrat economist, who had Bentham's words put into French.⁴⁴ By 1788, Bentham had begun writing his tracts in French; they were shipped to France and published in the newspaper *L'Ami du Peuple*.⁴⁵ Its editor was the terrorist Marat, who had beheaded every French scientist,

⁴³ The fact that British intelligence ran both the "left wing" anarchists in the French Revolution, and the Boston "right wing" insurrectionists in the War of 1812, was known to American leaders, such as Thomas Jefferson, who wrote: "The British have hoped more in their Hartford Convention. Their fears of republican France being now done away, they are directed to republican America, and they are playing the same game for disorganization here which they played in your country. The Marats, the Dantons, and Robespierres of Massachusetts are in the same pay, under the same orders, and making the same efforts to anarchise us, that their prototypes in France did there." Jefferson to Marquis de Lafayette, Feb. 14, 1814, *The Writings of Thomas Jefferson*, Vol. XIV, pg. 251.

⁴⁴ Halevy, *The Growth of Philosophical Radicalism*, Augustus Kelley, New York, 1949; p. 75.

⁴⁵ *Ibid.*, p. 147.

including the chemist Antoine Lavoisier.⁴⁶ Prior to the Revolution, Marat had spent years under Shelburne's personal tutelage.⁴⁷

"Nature has placed mankind under the governance of two sovereign masters, pleasure and pain. It is for them alone to point out what we ought to do, as well as to determine what we should do."⁴⁸

As quoted above, Bentham's "felicific calculus" or "hedonistic calculus," as elaborated in his *Principles of Morals and Legislation*, was not original. It was taken from the works of Giammaria Ortes.⁴⁹

Bentham turned his Venetian "hedonistic calculus" against Adam Smith (though he acknowledged his authority on economics), and attacked Smith's cautious endorsement of usury by writing his *Defense of Usury* (1787) -- which Smith then praised! http://american_almanac.tripod.com/ortes.htm

Jeremy Bentham's hatred for the American Revolution was notorious. He was asked by the infamous American traitor Aaron Burr, while Burr was still Thomas Jefferson's Vice-President, to draft a constitution for the Louisiana Territories which he intended should secede from the Union. After Burr killed Alexander Hamilton, in a duel,⁵⁰ he fled to England. There, he stayed as a guest at Bentham's estate, where they together worked on "Project X," a conspiracy to takeover of Mexico. Among those involved with Project X, were Jeremy's brother, General Samuel Bentham, and Henry Dundas.

Bentham campaigned for the legalisation of narcotics and pederasty. He once wrote:

⁴⁶ Lavoisier, credited with the discovery of oxygen, developed the technology used by Pierre S. DuPont to manufacture gunpowder in Delaware for the Continental Army during the Revolutionary War.

⁴⁷ Linda Frommer, "How British Jacobinism Destroyed the French Revolution," *New Solidarity*, June 7, 1977, New York.

⁴⁸ Halvey, p. 30.

⁴⁹ Ortes' economic and related writings are reprinted in *Scrittori classici italiani di economia politica*, ed. By P. Custodi (Milan: G.C. Stefanis, 1803-16). See also Webster G. Tarpley, *Giammaria Ortes and the Venetian Hoax of Carrying Capacity*, *The New Federalist*, Vol. VIII, No. 22, June 20, 1994, pp. 6-9. Karl Marx praised Ortes in his *Capital*, Vol. I, chap. XXV, sec. 4, emphasising Ortes' second general work on economics, *Della economia nazionale libre sei* on 1777.

⁵⁰ Bentham recorded what Burr said of the death of Hamilton in his *Works*: "He told me an account of his duel with Hamilton. He was sure of being able to kill him; so I thought it little better than murder." Also see Milton Lomask, *Aaron Burr, The Conspiracy and Years of Exile 1805-1836*, Farrar, Staus, and Gioux, New York, 1982; p. 309.

"I became very intimate once with a colony of mice. They used to run up my legs and eat crumbs from my lap...My fondness for animals exposed me to many jokes. An acquaintance of Wilson had come to dine with me. He had seen two beautiful asses and one had been named Miss Jenny. At Ford Abbey there was an ass of great symmetry and beauty to which I was much attached and which grew attached to me, each fondling the other..."⁵¹

Since poetry acts through metaphor and is never literal i.e. not knowable through sense perception, Bentham also said that he couldn't "trust poetry."

Against the New Dark Age

Hence! ye who snare and stupify the mind,
Sophists, of beauty, virtue, joy, the bane!
Greedy and fell, though impotent and blind,
Who spread your filthy nets in Truth's fair fane,
And ever ply your venom'd fangs amain!
Hence to dark Error's den, whose rankling slime
First gave you form! hence! lest the Muse should deign,
(Though loth on theme so mean to waste a rhyme),
With vengeance to pursue your sacrilegious crime.

- James Beattie
The Minstrel

Though written out of today's history books, there was a battle waged in Scotland against the evil philosophical radicalism of David Hume.

In May of 1770, a book appeared under the title, *An Essay on the Nature and Immutability of Truth, In Opposition to Sophistry and Scepticism*. The author was Dr. James Beattie, a Greek scholar and Professor of Moral Philosophy and Logic in the Marischal College and University of Aberdeen. The essay was a broadside against David Hume.

⁵¹ Jeremy Bentham, *The Works of Jeremy Bentham*, John Bowering, ed., William Tait, Edinburgh, 1843; vol. XI, p. 279.

Beattie had been a member of the "Wise Club," an association of theologians and medical professors in Aberdeen. The society was founded in 1758 by Rev. Dr. Thomas Reid, who had launched the first salvo against David Hume in his 1764 publication, *An Inquiry into the Human Mind on the Principles of Common Sense*. Reid's work was known to Robert Burns, who refers to it in several times.⁵²

In order to promote his book, against the "party of infidels",⁵³ Beattie enlisted the help of his close friend Dr. Thomas Blacklock.

In a letter to Dr. Blacklock, written in January of 1769, Beattie wrote:

"I want to show the world, that the skeptical philosophy is contradictory to itself, and destructive of genuine philosophy, as well as of religion and virtue; that it is in its own nature so paltry a thing (however it may have been celebrated by some), that no degree of genius is necessary to qualify a man for making a figure in this pretended science;...that sceptical philosophers, whatever they may pretend, are the corrupters of science, and the enemies of mankind."⁵⁴

Blacklock, though he had earlier been in the employ of Hume, used his position as one of Edinburgh's leading intellectuals to publish a most favourable review of Beattie's essay in the June 2, 1770 issue of the *Edinburgh Evening Courant*:

"The author [Beattie] of this work, animated with a laudable zeal for the prosperity of science and the happiness of mankind...leads him to speak of the rise and progress of modern scepticism, and of the methods of investigation employed by Des Carte, Malebranche, Berkely and Hume; of which he endeavours to prove, that they are subversive of truth, and contrary to the genius of true philosophy. The same thing he further illustrates is an examination of two celebrated controversies, in which the modern sceptics have taken that side, which is contrary to common sense; these are the disputes relating to the existence of matter, and the liberty of human actions. Our author asserts human liberty, and the existence of a material world;..."

⁵² A reference can be found in Burns' *To James Tennant of Glandconner*. "An' Reid, to common sense appealing." Another, in the prologue he wrote for the actor William Woods' Benefit Night:

Philosophy, no idle pedant dream,
Here hold her search by heaven-taught
Reason's beam.

⁵³ William Forbes, *An Account of the Life and Writings of James Beattie, LL.D.*, E. Roper, London, 1824; Vol. 1, pp. 223-225; letter from Dr. Beattie to Dr. Porteus, August 18, 1772.

⁵⁴ *Ibid.*, Vol. 1. P. 124.

Dr. Beattie locates the dispute in the following manner:

"If all human things were to perish except Shakespeare, it might still be known from what sort of creature man was. If an inhabitant of another planet were to read Hume's *Treatise of Human Nature*, what notions of human nature would he gather from it? That man must believe one thing by instinct and believe the contrary by reason? That the universe is nothing but a heap of perceptions without substance?"⁵⁵

Beattie has the following to say on Hume's advocacy of slavery:

"Aristotle himself...argues, 'That men of little genius, and great bodily strength, are by nature destined to serve, and those of better capacity, to command; that the natives of Greece, and of some other countries, being naturally superior in genius, have a natural superior right to empire; and that the rest of mankind, being naturally stupid, are destined to labour and slavery.' [De Republ, lib, I cap.5.6.]...Mr. Hume argues nearly in the same manner in regard to the superiority of white men over black. 'I am apt to suspect,' says he, 'the negroes, and in general all the other species of men, (for there are four or five different kinds), to be naturally inferior to the whites. There NEVER WAS a civilised nation of any other complexion than white, NOR EVEN ANY INDIVIDUAL eminent either in action or speculation. NO ingenious manufacturers among them, NO arts, no sciences.--There are negroe-slaves dispersed all over Europe, of which NONE ever discovered any symptoms of ingenuity.' [Hume's 'Essay on National Characters'] These assertions are strong; but I know not whether they have any thing else to recommend them. For, first, though true, they would not prove the point in question, except it were also proved, that the Africans and Americans, even though arts and sciences were introduced among them, would still remain unsusceptible of cultivation. The inhabitants of Great Britain and France were as savage two thousand years ago, as those of Africa and America are at this time. And one may as well say of an infant, that he can never become a man, as of a nation now civilised...To suppose him (the negroe-slave) of an inferior species, because he has not thus distinguish himself, is just as rational, as to suppose any private European of an inferior species because he has not raised himself to the condition of royalty..."⁵⁶

⁵⁵ James Beattie, *An Essay on the Nature and Immutability of Truth*, A. Kincaid & J. Bell, Edinburgh, 1770.

⁵⁶ *Ibid.*, pp. 478-484.

Beattie's piece was widely circulated outside Scotland and England, in the Western Hemisphere.

In May of 1774, Beattie received a letter from St. Croix in the West Indies, penned by Rev. Hugh Knox, the man who had recruited the young Alexander Hamilton into Benjamin Franklin's circles.⁵⁷ Knox wrote:

"So much was I pleased, both with the matter and the manner of that book [*Essay on Truth* - ed.], that I deem it a Christian duty to promote the reading of it as far and wide as possible, as an antidote to the poison which David Hume has had the luck of vending and spreading so abundantly in the Christian world. For this purpose I put the copy of it which I had into the hands of as many as I think are capable of reading it with profit. I have sent for a couple of dozen copies more to North America, in order to give it as wide a spread as possible."⁵⁸

Dr. Beattie's work did not go unnoticed in the new American republic. On August 1, 1784, Benjamin Rush drafted a letter in Philadelphia addressed to Dr. James Beattie, notifying him that he had been admitted into Benjamin Franklin's American Philosophical Society.

Beattie's writings in philosophy and poetry, such as *The Minstrel*, had a direct influence on Robert Burns, as letters and poetical works, such as *The Ordination* and *The Vision*, testify.

⁵⁷ In 1751, a Scots-Irish, Presbyterian student named Hugh Knox arrived in Philadelphia. The principal of the Academy of Philadelphia, James Alison, recruited Knox to Franklin's intelligence network. In 1755, Knox went down to the West Indies as a minister; in 1771, on the island of St. Croix, he took one of his parishioners under his wing, Alexander Hamilton, then aged fourteen. With a letter of introduction from Knox, Hamilton went to live with Elias Boudinot in New York. Boudinot became director of the U.S. Mint in 1795.

⁵⁸ Margaret Forbes, *Beattie and His Friends*, Archibald Constable & Co., Ltd., Westminster, 1904, p. 112.

VIII. BURNS VERSUS SCOTT

"Poets are the unacknowledged legislators of the world."

- Percy Shelley
A Defense of Poetry

Today, if you walk through George Square in Glasgow, you will notice at the centre of the park, set upon a Roman column towering over the modest statues of Robert Burns and James Watt, the figure of Sir Walter Scott, ironically protected from the malevolence of Nature by Benjamin Franklin's lightning rod.

Over the recent years a few uninformed Scots have publicly asserted Sir Walter to have been in favour of Scottish independence, and that his *Letters of Malachi Malagrowth* represent "the first manifesto of modern Scottish nationalism." This is rather like claiming the Roman Emperor Tiberius to be one of the original Christian Apostles.

Sir Walter Scott was the chief agent for the Edinburgh division of the British Secret Intelligence Service (SIS), whose objective was to eradicate the ideas of the American Revolution. To that end, Scott waged a life-long campaign against Robert Burns.

Born into a minor aristocratic family, Walter Scott was enrolled to serve in the SIS. By 1802, with the establishment of the *Edinburgh Review*, Scott was involved in promoting "Philosophical Radicalism", Locke, Bentham, Smith and Romanticism.

Scott's service to the oligarchy, in its commitment to eliminate sovereign nation states, can be demonstrated by examining his novel *Quentin Durward*. It is a bold concoction of lies, designed to demonise King Louis XI (1423-1483),⁵⁹ the architect of the first modern, nation state – France. *Quentin Durward* has been the well spring of all the modern slanders against Louis XI, who was a product of the Italian Renaissance and understood that human creativity, that which differentiates us from mere beasts, is reflected through the development of science and technology. It was the economic and educational measures undertaken by Louis XI which, for the first time in history, brought the majority of that human population above the living standard of farm animals. Louis XI was the first European leader to place the welfare of the nation above the influence and rule of the landed-aristocracy, thus earning him the wrath of the oligarchy and Sir Walter Scott. In his introduction to the novel, Scott laments how Louis XI destroyed the "spirit of chivalry" of the "feudal system...of which if the earth were deprived, it would be difficult to conceive the existence of virtue among the human race." These are hardly the sentiments of a nationalist.

⁵⁹ For an excellent exposé of the subject, see Stephanie Ezrol, "[The Commonwealth of France's Louis XI](#)", *Fidelio* magazine, Vol. IV, No. 3, Fall 1995.

Another of Sir Walter Scott's novels, *Ivanhoe*, idealised Medieval English royalty. The American author Mark Twain, in his book *Connecticut Yankee in King Arthur's Court*, which he wrote to counter *Ivanhoe*, depicted the bestial condition of feudal life, as opposed to the labour-saving machinery of industrialism. Scott's Romanticism ultimately led to a belief in the occult; he became a collector of works on demonology.

Scott became a friend of the American traitor Aaron Burr in 1809; a personal letter of introduction was given to Burr by General Alexander Hope, for Scott.

In 1814, as British troops burned Washington D.C. to the ground, Sir Walter wrote a poem to support Great Britain's war against the American republic. Entitled *For A' That an' A' That*, Scott's piece was a crude parody of Robert Burns' republican song, *A Man's A' Man For A' That*. The last three verses of the Burns' song read:

Ye see yon birkie ca'd "a lord,"
 Wha struts, an' stars, an' a' that?
 Tho' hundreds worship at his word,
 He's but a cuif for a' that;
 For a' that an' a' that;
 His ribband, star, an' a' that,
 The man o' independent mind,
 He looks an' laughs at a' that.

A prince can mak a belted knight,
 A marquis, duke, an' a' that;
 But an honest man's aboon his might -
 Gude, faith, he mauna fa' that!
 For a' that an' a' that,
 Their dignities an' a' that,
 The pith o' sense, an' pride o' worth,
 Are higher rank than a' that.

Then let us pray that come it may,
 (As come it will for a' that),
 That Sense and Worth, o're a' the earth,
 Shall bear the gree, an' a' that.
 For a' that, an' a' that,
 It's comin yet for a' that,
 That Man to Man, the World o'er,
 Shall brithers be for a' that!

While Scott scrawled:

America they ca' that!
A coward plot her rats had got...
The British flag shall bear the grie,
And win the day for a' that!

America Opposes Scott

During the War of 1812, an American author and poet, James Kirk Paulding (1778-1860), launched a total assault against Sir Walter Scott as the leading exponent of the British Empire's designs to destroy the American republic. Based in New York City, he was a collaborator and brother-in-law of another American author, Washington Irving. Paulding had witnessed the suffering of family members at the hands of British tyranny during the Revolutionary War, including his cousin, John Paulding who had been one of those responsible for the capture of the British spy Major Andre and was later brutalised in the infamous British prison of New York.

Paulding understood that if the United States and humanity were to survive, then the British Empire would have to be annihilated. His life's work was dedicated towards that end.⁶⁰ In 1813, as the war progressed, Paulding wrote *The Lay of the Scottish Fiddle: a Tale of Havre de Grace, Supposed to be written by Walter Scott, Esq.* which was a parody of Sir Walter Scott's *The Lay of the Last Minstrel* (the 1805 work which had put Scott on the literary map). It was written with the intention of ridiculing certain American follies and exposing the crimes that the British had committed in the Chesapeake. Paulding condemned Scott's works as noxious because they distorted reality and inculcated in their readers a mythical, social ideal (i.e. feudalism) and false standards of behavior.

During April of 1813, Rear Admiral Sir George Cockburn, after burning down several Maryland towns, sized the town of Hampton, where, according to one British officer "Every horror was perpetrated with impunity – rape, murder, pillage – and not a man was punished."⁶¹ Paulding perceived that the barbaric actions of the British naval officers "arose in a great measure from a vehement desire to imitate the pernicious examples, held up in those mischievous books of chivalry, from time to time manufactured by [Scott]."⁶² He portrays the British commanders (Admiral Warren,

⁶⁰ Washington Irving testified in a letter he wrote to Paulding from France, following the defeat of Napoleon: "These late triumphs on the continent will be sore blows to Jim's plans -- they will materially delay the great object of his life -- the overthrow of the British Empire." Letter of Irving to Brevoort, 1:111.

⁶¹ *The Pictorial Field-Book of the War of 1812*, Benson Lossing, Harper & Brothers, New York, 1869, p. 684.

⁶² *The Lay of the Scottish Fiddle: A Poem in Five Cantos, Supposed to be written by W--- S--*, Esq. First American, from the Fourth Edinburgh Edition, London, 1814, p. 220.

Cockburn and Captain John Bereford) as “The Three Knights”; Bereford is described as a drunkard and a coward, and Sir Cockburn as a “border chief” descended from thieves:

For he had heard the valiant feats
Of British tars and British fleets
That bullies of the subject seas,
Not only rob their enemies,
But claim the right, as Yankees know,
To plunder friend as well as foe.

On January 3, 1814, Paulding sent a copy of his *Lay of the Scottish Fiddle*, along with a personal letter, to President James Madison. In the aftermath of the British having burned down Washington, D.C., Madison appointed the author (at the age of 37) secretary of the Board of Navy Commissioners. It was clear in the mind of the President that the qualifications of an American military leader, especially during time of war, were to know the enemy – Sir Walter Scott.⁶³

In his own day, the ordinary Scotsman had little sympathy for Sir Walter. This became evident during the public debates over the proposed Reform Bill of 1832, which would have granted voting rights to more of the population than just the land owners; only one in every 250 Scots had the right to vote. "I regard your gabble no more than the geese on the green," Scott told a Pro-Reform crowd in 1831. When Scott arrived to speak against the Bill at a public meeting in Jedburgh, the crowd stoned his carriage and greeted him with shouts of "Burke Sir Walter!"⁶⁴ Originally a lawyer by profession, Scott's views on these matters were identical to Lord Braxfield, to whom Scott had dedicated his advocate thesis.

⁶³ In addition to a lifelong career to establish an American literary culture that was not subjugated to the then degenerate reactionary literati of Europe, James Paulding played a leading role in advancing America's military and physical sciences. He was appointed Secretary of the Navy in 1838 by President Van Buren. In that position, he fitted out the United States Exploring Expedition of 1838-1842, which was an outgrowth of a request by Alexander von Humboldt for an expedition to map the earth's magnetosphere. The project was directed from Philadelphia by Benjamin Franklin's grandson, Alexander Dallas Bache, who had recently returned from conferences in Germany with Karl Gauss, and was setting up the Magnetischeverein. Paulding was also instrumental in the establishment of the U.S. Naval Academy at Annapolis, Maryland. Today, the remains of John Paul Jones is entombed and honoured in the crypt below the Academy chapel. For more on James Kirk Paulding, see the unpublished manuscript [*America versus Sir Walter Scott: the Case of James Kirk Paulding*](#), by Mark Calney.

⁶⁴ In the early 19th century, the practice of suffocating innocent victims in order to sell their corpses to Edinburgh medical schools, was commonly called "burking" after William Burke, of the Burke and Hare case.

Scott's service to the Crown is highlighted by his personal relationship to the Prince Regent (King George IV 1820-1830), who had offered him the post of Poet Laureate in 1813, during Britain's wars with America and Napoleon. Though Scott declined the position, he collaborated with the Regent in 1815 on a project for re-discovering the Crown jewels of the Scottish monarchy. In 1818, Scott was credited with the discovery of the Scottish Regalia in the Crown Room of Edinburgh Castle. Thus, his much sought after title of "Sir" was bestowed upon him by the Regent who appointed him a Baronet.

After attending the coronation of King George IV, Sir Walter organised the visit of the King to Edinburgh in 1822. Scott was rewarded with the promise that the Scottish peerages, forfeited in the risings of 1715 and 1745, would be restored.

Scott's hatred of Burns was shared by his son-in-law John G. Lockhart who wrote a biography of Robert Burns, who is portrayed as a wretched alcoholic.

Lockhart claims that Burns, after becoming drunk at a local pub, fell asleep in the snow; this, he said, brought on his fatal illness.⁶⁵ This tale has been widely accepted as standard historiography.

Burns was not the only classical poet to suffer at Lockhart's hands. As a writer for *Blackwood's* magazine, and as editor of the London-based *Quarterly Review*, Lockhart attacked the best English poets of the day. His enemies included John Keats and Edgar Allan Poe. Of Poe, with whom he had a long running battle (see Poe's *How to Write a Blackwoods Article*), it was said he had died from alcohol and opiates. In fact, he was murdered. As Lockhart and Scott knew, Poe was, like James Fenimore Cooper, a leading republican intelligence agent, whose literary work exposed the modus operandi of the oligarchy. Cooper's novel, *The Bravo*, is an excellent example.

Testimony to Sir Walter Scott's role in the Confederate insurgency,⁶⁶ is given by Mark Twain in his 1883 non-fiction *Life on the Mississippi*:

⁶⁵ Burns biographer James Mackay has recently shown there was no snow in the area Lockhart alleges the incident to have taking place. Macaky presented this evidence at the 1994 Burns Conference at the University of Strathclyde in Glasgow, at which the author also spoke.

⁶⁶ The secessionist movement in the United States, and the assassination of President Abraham Lincoln, was orchestrated by the British. A central role was played by the Scottish Rite Order of Freemasonry, under its supreme commander of the U.S. Southern Jurisdiction, Albert Pike. Pike later became the key organiser and chief judicial officer of the Ku Klux Klan.

Sir Walter Scott's racialism is displayed in novels such as *The Talisman* and *Ivanhoe*; black Africans were "natural" slaves, based on his Old Testament belief that blacks were descendants "of the race of Ham, the unfaithful son of Noah," and thereby condemned to serve. This notion was adopted by the ante-bellum, U.S. Southern "aristocracy," who would often name their children after the characters in *Ivanhoe*. Later, American pulp-novelist Thomas Dixon took the image of the "burning cross" from Scott's *Lady of the Lake* as his ritual gathering symbol for the Ku Klux Klan in his book *The Clansman*. Dixon's book was made into D.W. Griffith's movie *Birth of a Nation*, and with the help of anglophile President Woodrow Wilson, launched the rebirth of the KKK as a mass organisation in the US in 1915. See the article [D.W. Griffith and the 'Birth of a Monster': How the Confederacy Revived the KKK and Created Hollywood](#) by Mark Calney, *New Federalist*, January 11, 1993.

"Then comes Sir Walter Scott with his enchantments, and by his single might checks this wave of progress, and even turns it back; sets the world in love with dreams and phantoms; with decayed and swinish forms of religion; with decayed and degraded systems of government; with the sillinesses and emptinesses, sham grandeurs, sham gauds, and sham chivalries of a brainless and worthless long-vanished society. He did measureless harm; more real and lasting harm, perhaps, than any other individual that ever wrote...But for the Sir Walter disease, the character of the Southerner -- or Southron, according to Sir Walter's starchier way of phrasing it -- would be wholly modern...It was Sir Walter that made every gentleman in the South a Major or a Colonel, or a General or a Judge, before the war; and it was he, also, that made these gentlemen value these bogus decorations. For it was he that created rank and caste down there, and also reverence for rank and caste, and pride and pleasure in them....Sir Walter had so large a hand in making Southern character, as it existed before the war, that he is in great measure responsible for the war."

Burns knew only too well the stuff of which such Scots as Sir Walter Scott was made, and he immortalised such traitors in popular song:

Farwell to a' our Scottish fame...
We're bought and sold for English gold -
Such a parcel of rogues in a nation!⁶⁷

National Poet

Burns loved the Scottish people, and all mankind, not for what they were, but for what they could become. He took personal responsibility for the future of his nation. This is a republican concept -- the idea that as a citizen of the republic, it is your responsibility, your duty, to do what ever may be required to protect and preserve the republic, no matter what your occupation or station.⁶⁸

⁶⁷ Song by Robert Burns, *Such a Parcel of Rogues in a Nation* (1791). On his death-bed, Beethoven threw a book by Scott aside, saying to his friend Schindler, "after all, the fellow writes for money only."

⁶⁸ After the War of Independence, the Revolutionary leadership established in 1783, a private, political intelligence organisation to protect the young republic, and spread its ideas to the world. This was the Society of the Cincinnati, founded the same year as the Shelburne coup in Great Britain, by George Washington, Baron von Stueben, the Marquis de Lafayette, Verplanck and Alexander Hamilton. They took its name from the Roman leader Cincinnatus, a farmer who, when the Republic was threatened by foreign invaders, took up arms, defeated the enemy, and returned to his farm.

That principle is reflected in his work to save and advance Scottish culture. Burns applied to the peculiarities of daily life, the principles of metaphor through humor, irony, and even satire, to make the Scots reflect upon some of their more backward thinking. At a time of physical hardship and subjugation, Burns' poetry and songs were a welcome medicine. He spoke of Scots' dignity and gave them hope.

One of his best poems, which he had considered drafting into a play, was *Tam O' Shanter*. The pathetically funny namesake of the story, after staying out late drinking and carousing, is riding his horse Meg home when he sees lights and hears music coming from the ruins of the Kirk Alloway. Tam stops to spy upon the festivities of "auld Nick" (the Devil) and a host of resurrected murderers and hooligans. Enthralled by a scantily clothed lassie, he shouts aloud his enthusiasm, only to be discovered. He so narrowly escapes the demons that Meg's tail is torn off:

But pleasures are like poppies spread;
 You seize the flou'r, its bloom is shed;
 Or like the snow falls in the river,
 A moment white -- then melts for ever;
 Or like the borealis race,
 That flit ere you can point their place;
 Or like the rainbow's lovely form
 Evanishing amid the storm...

Now, wha this tale o' truth shall read,
 Ilk man and mother's son take heed:
 Whene'er to drink you are inclin'd,
 Or cutty-sarks rin in you mind,
 Think! ye may buy the joys o'er dear;
 Remember Tam O' Shanter's mare.

Perhaps Robert Burns' most important legacy is the work he did in music. Before his untimely death in 1774 at the age of twenty-four, Robert Fergusson, wrote the following (excerpted from his *Elegy, On the Death of Scots Music*):

On Scotia's plains, in days of yore,
 When lads and lasses tartan wore,
 Saft music rang on ilka shore,
 In hamely weid;
 But harmony is now no more,
 And music dead.

Round her the feather'd choir would wing,
Sae bonnily she wont to sing,
And sleely wake the sleeping string,
 Their sang to lead,
Sweet as the zephyrs of the spring;
 But now she's dead. ...

At glomin now the bagpipe's dumb,
Whan weary owsen hameward come;
Sae sweetly as it wont to bum,
 And pibrachs skreed;
We never hear its warlike hum;
 For music's dead. ...

Now foreign sonnets bear the gree,
And crabbit queer variety
Of sound fresh sprung frae Italy,
 A bastard breed!
Unlike that saft-tongu'd melody
 Which now lies dead. ...

O Scotland! that cou'd yence afford
To bang the pith of Roman sword,
Winna your sons, wi' joint accord,
 To battle speed?
And fight till Music be restor'd,
 Which now lies dead.

Burns first encountered the works of Fergusson in 1782, and testified in prose and verse that Fergusson had the most profound influence on him then any other poet. After a brief three-year career as a poet, Fergusson died a declared "pauper lunatic" under the horrible, physical conditions of Edinburgh's "mad house", the Bedlam. Upon learning that Fergusson lay in an unmarked grave at Canongate cemetery, Burns paid for a headstone and composed the inscription upon it for his fellow bard. The last two lines of those verses are:

But dear to fame thy Song immortal lives,
A nobler monument than Art can show.

Burns answered Fergusson's patriotic challenge and took responsibility for saving Scotland's musical heritage from the onslaught of London's cultural warfare.⁶⁹ Burns not only contributed his own musical works but those songs would have an international influence on the ballad music of the German classical composers.

In 1786-87, during his first visit to Edinburgh, Robert Burns met James Johnson, a publisher who enlisted Burns' help to gather and print a comprehensive collection of Scottish music. Burns was a major contributor and editor of what would be called *The Scots Musical Museum*. As Burns had predicted, *The Scots Musical Museum*, published in five volumes, became "the text book and standard of Scottish song and music." Dr. Blacklock and James Beattie also made contributions.

From the spring of 1787 until his death in 1796, the *Scots Musical Museum* was the centre of Burns' artistic work. With the exception of *Tam O'Shanter*, written in 1790, his major work was not the composition of poetic verse per se but was song. Burns revived and wrote verse for traditional Scottish folk music. He wrote the verse for over 200 Scottish tunes, and in some cases, the music as well.

In 1792, Burns became associated with a similar effort proposed by George Thomson (*Scottish Airs*), who, unfortunately, proved to be an Anglophile who altered the Bard's songs, and then mutilated the manuscripts of Beethoven's arrangements.

Unlike Scott, Burns' motivation for his Scottish song project was not earthly compensation, as witnessed in a letter Burns sent to George Thomson in September 1792:

"As to any remuneration, you may think my Song either above, or below price; for they shall absolutely be the one or the other. -- In the honest enthusiasm with which I embark in your undertaking, to talk of money, wages, fee, hire, etc. would be downright Sodomy of the Soul! -- A proof of each of the Songs that I compose or amend, I shall receive as a favor. -- In the rustic phrase of the Season, 'Gude speed the Wark!'"

Burns' songs not only became popular in Scotland, but variations of the songs were composed by Germany's greatest artists, such as Hayden, Mendelssohn, and Beethoven, and thereby reached the broader populations of Europe and the New World. Burns was a major influence in the development of the ballad form in Germany.

The most important person responsible for the transmission of the works of Robert Burns into Germany (bypassing London's cultural gendarmes) was the Reverend James Macdonald (1771-1810). Macdonald was a personal friend of Goethe and Herder, and associated with Schiller and other figures of the Weimar classical

⁶⁹ One aspect of the London-directed Scottish "Enlightenment" was the attempt to eliminate all Scottishisms from the language. Fergusson had begun to popularise the Scot's tongue in his poetry (specifically using the Scots of Edinburgh Old Town, though he came from Aberdeen). The Scots-English dialect became the cultural, and necessarily political, hallmark of Burns' work.

period. On November 25, 1796, four months after the death of Burns, Karl August Boettiger, headmaster of the Weimar Gymnasium wrote to his friend Andrew Dalzel, Professor of Greek and Librarian at the University of Edinburgh, about his new Scottish visitor, James Macdonald, from whom he had received a copy of Burns' poems:

"The favorite topic of our conversation is Caledonia, and our common table and tea-table talk runs about old Gaelic antiquities, Ossian's songs, the Western Islands, the picturesque beauties of the Highlands, the smiling farms and busy throngs of the Lowlands, and such other things as we want very vastly to hear related by eye witnesses, as we want very much a true statement of all these cases, in order to be undeceived and weaned from the prejudices we have sucked from English authors...thus, for instance, I had never heard of that true poetical genius the late Mr. Burns."⁷⁰

As Burns understood, the idea of Scotland as a nation, began first as an idea. Though tyrants may build walls and exert temporal power over the physical existence of a people, they can never truly conquer the minds of those who chose freedom over slavery.

Then let us pray that come it may,
 (As come it will for a' that),
That Sense and Worth, o're a' the earth,
 Shall bear the gree, an' a' that.
For a' that, an' a' that,
 It's comin yet for a' that,
That Man to Man, the World o'er,
 Shall brithers be for a' that!

⁷⁰ Andrew Dalzel, *History of the University of Edinburgh from its Foundation, With a Memoir of the Author*, 2 vols., Edinburgh, 1866, I, pp. 131-132.



Sir Walter Scott
1771-1832

Romantic scribbler, intelligence agent for the British oligarchy, and enemy of America.

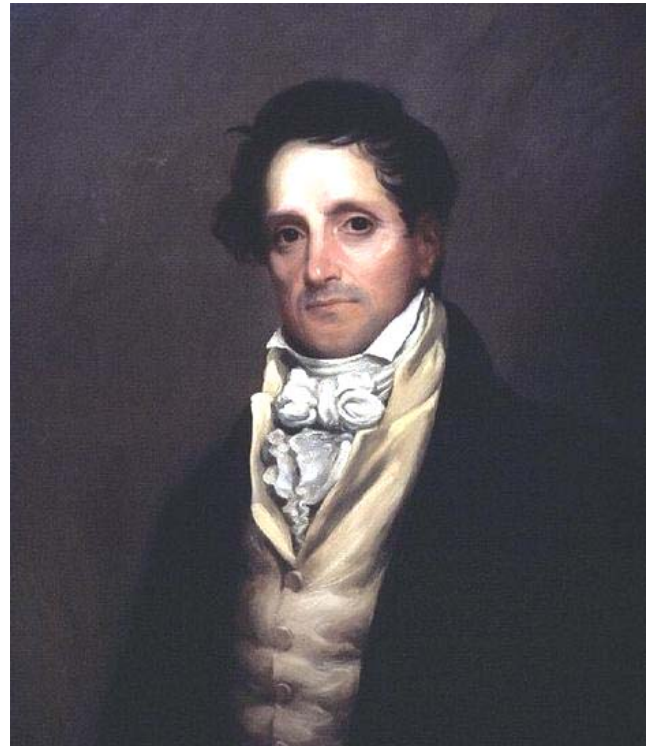

James Kirk Paulding
1778-1860

American writer, whose "Lay of the Scottish Fiddle," a parody of Scott that lampooned the British Empire's barbarous 'chivalry' in the War of 1812, earned him an appointment to the U.S. Board of Naval Commissioners by President James Madison.



Rear Admiral Sir George Cockburn
1771-1832

British officer responsible for the massacre of American civilians, the burning of Washington, D.C., and the chief character in Paulding's literary attack.



Capture and burning of Washington by the British in 1814

APPENDIX

A. Works of Robert Burns which reflect the ideas of the American Revolution:

SCOTS, WHA HAE⁷¹

SCOTS, wha hae, wi' Wallace bled,
Scots, wham Bruce has aften led,
Welcome to your gory bed,
Or to Victorie!

Now's the day, and now's the hour;
See the front o' battle lour;
See approach proud Edward's power -
Chains and Slaverie!

Wha will be a traitor knave?
Wha can fill a coward's grave?
Wha sae base as be a slave?
Let him turn and flee!

Wha, for Scotland's King and Law,
Freedom's sword will strongly draw,
Freeman stand, or Freeman fa',
Let him on wi' me!

By Oppression's woes and pains!
By your Sons in Servile chains!
We will drain our dearest veins,
But they shall be free!

Lay the proud Usurpers low!
Tyrants fall in every foe!
Liberty's in every blow! -
Let us do or die!

⁷¹ In a letter Burns wrote in January of 1794 to the man whose life was saved by Benjamin Franklin, Lord Buchan, the poet ended his description of this song by stating: "Liberty! Thou art a prize truly and indeed invaluable, for never canst thou be too dearly bought!"

ADDRESS OF BEELZEBUB

To the Right Honourable the Earl of Breadalbane, President of the Right Honourable and Honourable the Highland Society, which met on the 23rd of May last at the Shakespeare Covent Garden, to concert ways and means to frustrate the designs of five hundred Highlanders, who as the Society were informed by Mr. M'Kenzie of Applecross, were so audacious as to attempt an escape from their lawful lords and masters whose property they were, by emigrating from the lands of Mr. Macdonald of Glengary to the wilds of Canada, in search of that fantastic thing -- LIBERTY.

LONG life , my Lord, an' health be yours,
Unskaited by hunger'd Highland boors;
Lord grant me nae duddie, desperate beggar,
Wi' dirk, claymore, and rusty trigger,
May twin auld Scotland o' a life
She likes -- as butchers like a knife.
Faith you and Applecross were right
To keep the Highland hounds in sight;
I doubt na! they wad bid nae better,
Then let them ance out owre the water,
Then up among thae lakes and seas,
They'll mak what rules and laws they please:
Some daring Hancock, or a Franklin,
May set their Highland bluid a-ranklin;
Some Washington again may head them,
Or some Montgomery, fearless, lead them,
Till God knows what may be effected
When by such heads and hearts directed,
Poor dunghill sons of dirt and mire
May to Patrician rights aspire!
Nae sage North now, nor sager Sackville,
To watch and premier o'er the pack vile, --
An' whare will ye get Howes and Clintons
To bring them to a right repentance --
To cove the rebel generation,
An' save the honour o' the nation?
They, an' be d--d! what right hae they
To meat, or sleep, or light o' day?
Far less -- to riches, pow'r, or freedom,
But what your lordship likes to gie them?
But hear, my lord! Glengarry, hear!
Your hand's owre light to them, I fear;
Your factors, grieves, trustees, and bailies,
I canna say but they do gaylies;

They lay aside a' tender mercies,
An' tirl the hallions to the birses;
Yet while they're only point'd and herriet,
They'll keep their stubborn Highland spirit:
But smash them! crash them a' to spails,
An' rot the dyvors i' the jails!
The young dogs, swinge them to the labour;
Let wark an' hunger mak them sober!
The hizzies, if they're aughtlins fawsont,
Let them in Drury-lane be lesson'd!
An' if the wives an' dirty brats
Come thiggin at your doors an' yetts,
Flaffin wi' duds, an' grey wi' beas',
Frightin away your ducks an' geese;
Get out a horsewhip or a jowler,
The langest throng, the fiercest growler,
An' gar the tatter'd gypsies pack
Wi' a' their bastards on their back!

Go on, my Lord! I lang to meet you,
An' in my house at hame to greet you;
Wi' common lords ye shanna mingle,
The benmost neuk beside the ingle,
At my right han' assigned your seat,
'Tween Herod's hip an' Polycrate:
Or if you on your station tarrow,
Between Almagro and Pizarro,
A seat, I'm sure ye're weel deservin't;
An' till ye come -- your humble servant,

BEELZEBUB.

June 1st, Anno Mundi 5790

ODE FOR GENERAL WASHINGTON'S BIRTHDAY

No Spartan tube, no Attic shell,
No lyre Eolian I awake;
'Tis Liberty's bold note I swell,
They harp, Columbia, let me take!
See gathering thousands, while I sing,
A broken chain, exulting, bring,
And dash it in a tyrant's face!
And dare him to his very beard,
And tell him, he no more is feared,
No more the Despot of Columbia's race!
A tyrant's proudest insults braved,
They shout -- a People freed! They hail an Empire saved.

Where is Man's god-like form?
Where is that brow erect and bold –
That eye that can, unmoved, behold
The wildest rage, the loudest storm,
That e'er created fury dared to raise?
Avaunt! thou caitiff, servile, base,
That tremblest at a Despot's nod,
Yet, crouching under the iron rod,
Canst laud the hand that struck th' insulting blow!
Art thou of man's Imperial line?
Dost boast that countenance divine?
Each skulking feature answers, No!
But come, ye sons of Liberty,
Columbia's offspring, brave as free,
In danger's hour still flaming in the van,
Ye know, and dare maintain, The Royalty of Man!

Alfred! on thy starry throne,
Surrounded by the tuneful choir,
The Bards that erst have stuck the patriot lyre,
And roused the freeborn Briton's soul of fire,
No more thy England own!
Dare injured nations form the great design,
To make detested tyrants bleed?
Thy England execrates the glorious deed!
Beneath her hostile banner waving,
Every pang of honor braving,
England in thunders calls, "The Tyrant's cause is mine!"

That hour accurst how did the fiends rejoice,
And hell, thro' all her confines, raise the exulting voice,
That hour which saw the generous English name
Linkt with such damned deed of everlasting shame!

Thee, Caledonia! thy wild heaths among,
Famed for the martial deed, the heaven-taught song,
To thee I turn with swimming eyes;
Where is that soul of Freedom fled?
Immingled with the mighty dead,
Beneath that hallowed turf where Wallace lies
Hear it not, WALLACE! in they bed of death.
Ye babbling winds! in silence sweep,
Disturb not ye the hero's sleep,
Nor give the coward secret breath!
Is this the ancient Caledonian form,
Firm as her rock, resistless as the storm?
Show me that eye which shot immortal hate,
Blasting the Despot's proudest bearing;
Show me that arm which, nerved with thundering fate,
Crush'd Usurpation's boldest daring! –
Dark-quenched as yonder sinking star,
No more that glance lightens afar;
That palsied arm no more whirls on the waste of war.

A MAN'S A MAN FOR A' THAT

Is there for honest Poverty
That hings his head, an' a' that;
The coward slave -- we pass him by,
We dare be poor for a' that,
For a' that, an' a' that.

Our toils obscure an' a' that,
The rank is but the guinea's stamp,
The Man's the gowd for a' that.

What though on hamely fare we dine,
Wear hoddin grey, an' a' that;
Gie fools their silks, and knaves their wine;
A Man's a Man for a' that:

For a' that, and a' that,
Their tinsel show, an' a' that;
The honest man, tho' e'er sae poor,
Is king o' men for a' that.

Ye see yon birkie, ca'd a lord,
Wha struts, an' stares, an' a' that;
Tho' hundreds worship at his word,
He's but a coof for a' that:

For a' that, an' a' that,
His ribband, star, an' a' that:
The man o' independent mind
He looks an' laughs at a' that.

A prince can mak a belted knight,
A marquis, duke, an' a' that;
But an honest man's aboon his might,
Gude faith, he maunna fa' that!

For a' that, an' a' that;
Their dignities an' a' that;
The pith o' sense, an' pride o' worth,
Are higher rank than a' that.

Then let us pray that come it may,
(As come it will for a' that,)
That Sense and Worth, o'er a' the earth,
Shall bear the gree, an' a' that,

For a' that, an' a' that,
It's coming yet for a' that,
That Man to Man, the world o'er,
Shall brithers be for a' that.

B. ROBERT BURNS & ABRAHAM LINCOLN

How the National Poet of Scotland and the National Poet of England Won the U.S. Civil War

by Mark Calney

With Mark Twain's stinging indictment that "Sir Walter had so large a hand in making Southern character, as it existed before the war, that he is in great measure responsible for the war," it is ironic and fitting that the man who led the Union forces to a just victory over the Confederacy in the great U.S. Civil War – President Abraham Lincoln – was an avid devotee of the poetry of Robert Burns and "had never been able to finish *Ivanhoe*."⁷² The Confederacy, like Sir Walter Scott's career, was conceived and nurtured by the highest levels of the British oligarchy.

Though born in a log cabin in 1809 and raised in the wilderness of the American frontier with little formal education, Abraham Lincoln was no country bumpkin. He stands as one of the great intellects of universal history, without whom the United States, along with its founding principles, would have been extinguished. Lincoln, like the nation he led, was a product of the best of the Renaissance culture of Europe. He understood that a republican citizenry can only be created if they live, not only in the present, but also to fulfill the debts of those that came before them and to ensure the future of their progeny. That is the core concept of morality. It is that which differentiates us from the beasts, like the poor mouse from Burns' famous poem whose existence is "the present only thoucheth thee,"⁷³ or the modern "liberal" (especially of the Baby Boomer generation) who lives only to squeeze out the last dredges of physical pleasure while hoping to die on the same day that his credit cards are all 'maxed-out.'

The young Mr. Lincoln once remarked to his law partner, William Herndon,⁷⁴ "There are no accidents in my philosophy. Every effect must have a cause. The past is the cause of the present, and the present will be the cause of the future. All these are links in the endless chain stretching from the Infinite to the finite." That *simultaneity of eternity* (or *temporal eternity*) is what guided Lincoln's thoughts and actions during the Civil War, which is sometimes properly referred to as the Second American Revolution. This concept was profoundly and beautifully exhibited in the President's famous Gettysburg Address, delivered to commemorate the cemetery that, four and one-half months earlier, had been the site of the most important battle of the Civil War:

⁷² *Abraham Lincoln, a Biography* by Benjamin P. Thomas, The Modern Library, New York, (1952) 1968, p. 476.

⁷³ *To a Mouse, On Turning her up in her Nest with the Plough, November 1785* by Robert Burns.

⁷⁴ *Herndon's Lincoln: The True Story of a Great Life* by William H. Herndon and Jesse Weik; Belford, Clarke & Co.; Chicago, New York and San Francisco; 1889, v. 3, p. 438. Herndon was Lincoln's law partner and friend for twenty years.

Four score and seven years ago our fathers brought forth on this continent, a new nation, conceived in Liberty, and dedicated to the proposition that all men are created equal. ... The world will little note, nor long remember what we say here, but it can never forget what they did here. It is for the living, rather, to be dedicated to the great task remaining before us – that from these honored dead we take increased devotion to the cause for which they gave the last full measure of devotion – that we here highly resolve that these dead shall not have died in vain – that this nation, under God, shall have a new birth of freedom – and that government of the people, by the people, for the people, shall not perish from the earth. [November 19, 1863]

This was not a new concept, for it is the soul of the American Republic. It is the Preamble of the U.S. Constitution:

We the people of the United States, in order to form a more perfect union, establish justice, insure domestic tranquility, provide for the common defense, promote the general welfare, and secure the blessings of liberty to ourselves and our posterity, do ordain and establish this Constitution of the United States of America.⁷⁵

In addition to the Bible, large portions of which he had committed to memory, Abraham Lincoln had two great literary friends whom he cherished and always had actively in his mind – Robert Burns and William Shakespeare. Both bards have historically been the object of hatred by the London-centred oligarchy up to the present day. It is not an accident, for example, that after more than 350 years it took an American to rebuild the Globe Theater in London, as a tribute to England's greatest poet.

“The honest man, tho' e'er sae poor, Is king o' men for a' that”

After having moved from Kentucky to what is now Spencer County, Indiana, Lincoln records, “There I grew up. There were some schools, so called, but no qualification was ever required of a teacher, beyond ‘readin, writin and ciphering.’”⁷⁶ Though he had several important mentors, the future President was essentially self taught and possessed an extraordinary memory.

⁷⁵ This was also the same concept used by President Franklin D. Roosevelt, when he gave his acceptance speech for the Democratic Party Presidential nomination in 1932 and announced his ‘New Deal’ policy to protect the General Welfare of the population against the ravages of the Great Depression. See *The Public Papers and Address of Franklin Roosevelt*, v. 2 pp.4-5.

⁷⁶ From a handwritten, autobiographical sketch by Abraham Lincoln made in December 1859, and reprinted as a facsimile in *The Life of Abraham Lincoln* by Ward H. Lamon, originally printed 1872 by James R. Osgood and Company of Boston and reprinted in 1999 by University of Nebraska Press. This is one of the best prime source accounts of Lincoln life, compiled from documents and interviews of friends and associates of the President. Lamon was a close personal friend of Lincoln who accompanied him to Washington D.C. and served as his personal body guard during the Civil War.

At the age of eighteen, Abraham Lincoln came into possession of a book of Robert Burns' poetry. According to Noah Brooks, an Illinois newspaper man who was close to Lincoln, that book was:

“A thick chunky volume, as he afterwards described it, bound in leather and print in very small type. This book he kept long enough to commit to memory almost all its contents. And ever after, to the day of his death, some of the familiar lines of the Scottish poet were as ready on his lips as those of Shakespeare, the only poet who was, in Lincoln's opinion, greater than Robert Burns.”⁷⁷

However, it was not until he moved to New Salem in 1831 that Lincoln developed a deeper appreciation and love for Burns' works, as well as the plays of Shakespeare. This was due to his friendship with a Scots-American by the name of Jack Kelso. A sometimes school teacher and merchant, Kelso was a free-spirit who loved hunting and fishing more than work. Unlike, other residents of New Salem who fought when they had a dram too many, Jack Kelso would spout endless quotations from Burns poetry and Shakespeare. Though 'Honest Abe' never drank alcohol, he was immediately drawn to Kelso and his poetic interpretations of life. And, even though he also disliked fishing as much as alcohol, he began to accompany Kelso on his expeditions:

“...they became exceedingly intimate; that they loitered away whole days together, along the banks of the quiet streams; that Lincoln learned to love inordinately our 'divine William' and 'Scotia's Bard,' whom his friend mouthed in his cups, or expounded more soberly in the intervals of fixing bait and dropping line. Finally he and Kelso boarded at the same place;”⁷⁸

There is no doubt that it was also Kelso to whom Lincoln is indebted for his reported mastery of the Scots dialect. Burns' hilarious and biting humor appealed to Lincoln's nature, and the backwoods rail-splitter could certainly identify with the ploughman poet who talked of “honest Poverty” and the “Royalty of Man.” His favorite Burns poems were *Tam O'Shanter*, *Holy Willie's Prayer*, *Address to the Deil*, *Highland Mary*, *Dr. Hornbook*, *The Cotter's Saturday Night*, and *A Mans A Man For A' That*.

This is attested to by Milton Hay, who worked as a clerk in Lincoln's law office in Springfield, Illinois (1839-1840), when he conveyed the following to a reporter:

“He [Lincoln] could quote very nearly all of Burns's poems by memory. I have frequently heard him quote the whole of *Tam O'Shanter*, *Holy Willie's Prayer*, and a large portion of *The Cotter's Saturday Night* from memory. He acquired the Scottish accent and could render Burns perfectly. ... I have been with him in that little office and heard him recite with the greatest of admiration and zest Burns's

⁷⁷ *Washington D.C. in Lincoln's Time* by Noah Brooks, Collier, N.Y., 1962. Lincoln had planned to make Brooks his personal secretary in May 1865, but was assassinated on April 14th of that year.

⁷⁸ Lamon, p. 144-145.

ballads and quaint things. That was one of the sources of his wisdom and wit. As years passed on he did not quote Burns as much. He had then taken up Shakespeare and became greatly interested in him; and yet I fancy that a great deal of Abraham Lincoln is bottomed on Robert Burns and William Shakespeare. Sometimes I think I can see traces of both men in his writings.”⁷⁹

In 1860, when provided a manuscript of his campaign biography by William Dean Howells for any corrections, Lincoln let stand the following, “When practicing law before his election to Congress, a copy of Burns was his inseparable companion on the circuit; and this he pursued so constantly, that it is said he now has by heart every line of his favorite poet.”

Lincoln’s fondness of *Holy Willie’s Prayer*, with its untrammelled scorn and delicious lampoon for the hypocrisy of the petty, self-righteous Christian parishioner, lent supposed credence to a slander that was circulated about Lincoln that he was an atheistic “skeptic” (a la David Hume!). The fact that Lincoln, during his entire life, had never been a member of any Christian congregation, only seemed to reinforce the basis of the slander. When asked by Henry Deming, a Congressman from Connecticut, why he had never joined a church, Lincoln replied:

“When any church will inscribe over its altars, as its sole qualification for membership, the Savior’s condensed statement for the substance of both law and gospel, ‘Thou shalt love the Lord thy God with all thy heart and with all thy soul, and with all they mind, and thy neighbor as thyself,’ that church will I join with all my heart and soul.”

The Pat Robertson’s of the world should please take note. Today, Lincoln’s mind represents something completely alien to the vast majority of so-called “fundamentalist Christians” who may be quick to quote Bible “prophesy” and profess their “faith” yet fail to act on the principles of Christianity, thinking that their place in heaven is guaranteed simply because they “believe.” Lincoln’s knowledge of the Bible inescapably led him to examine his namesake, Abraham, who was requested by God *to act* to sacrifice his son Isaac. This is discussed in the second chapter of the Epistle of James: “Even so faith, if it hath not works, is dead, being alone. Yea a man may say, Thou hast faith without thy works, and I will shew thee my faith by my works.” This is the central idea of Cotton Mather’s *An Essay Upon the Good (Bonifacius)*, which so influenced Benjamin Franklin and became the founding principle upon which the American republic was founded. This idea is also, I believe, why Lincoln was so enthralled with the soliloquy of King Claudius in Shakespeare’s *Hamlet* (“*Words without thoughts never to heaven go.*”).

On January 25, 1859, the town of Springfield, Illinois held a Burns Supper at the local concert hall to celebrate the one-hundredth anniversary of the poet’s birth. The attendants sang the Burns songs *John Anderson, My Jo; Green Grow the Raches, O; A*

⁷⁹ From an interview Hay did in Saratoga, New York in 1883. From *Lincoln’s Favorite Poets* by David J. Harkness and R. Gerald McMurtry, University of Tennessee Press, Knoxville, 1959, p. 6.

Heart-Warm Fond Adieu, and *'Twas Even: the Dewy Fields Were Green*.⁸⁰ Abe Lincoln gave the “Immortal Memory” presentation, an oration and toast to Robert Burns. Andrew Carnegie, the Scotsman who created the modern steel industry in America, beginning with his service to the Union Army, searched for a record of that speech, but “Unfortunately no trace of this lecture can be found. We have searched for it in vain.”⁸¹

Six years later, on January 24th, President Lincoln was requested to make a “recognition of the genius of Scotland’s bard, by either a toast, a sentiment, or in any other way you may deem proper,” for the following night’s Burns Supper to be held by the Washington, D.C. Burns Club. The person who made the request was Alexander Williamson, a Scotsman who was the tutor of Lincoln’s sons Tad and William Wallace, and was the secretary for that local Burns Club. Lincoln’s response was read to the proceedings the following evening:

“I can not frame a toast to Burns. I can say nothing worthy of his generous heart, and transcendent genius. Thinking of what he has said, I can not say anything which seems worth saying.”⁸²

**“For God’s sake, let us sit upon the ground
And tell sad stories of the death of kings”**

Abraham Lincoln is reported to have once said:

“If all other books were destroyed excepting the Bible and Shakespeare, the world would still have the best literature preserved. Shakespeare’s mind was like a sea to which all others in the world were as tributaries, and why should we not drink from this inexhaustible fountain. ... [Shakespeare was] one of those geniuses God leaves unbridled, that he might dip into the infinite as far as deep as he liked!”⁸³

⁸⁰ Rufus Rockwell Wilson, *Intimate Memories of Lincoln*, Elmira Press, New York, Primavera Press, 1945; pp. 423-424.

⁸¹ Carnegie made these comments while he dedicated a statue of Robert Burns at Montrose, Scotland. He concluded by stating: “What would one give for a copy? Imagine Lincoln and Burns together, both men who held their patents of nobility direct from the hand of Almighty God.” *Lincoln’s Favorite Poets*, p. 11.

⁸² Alexander Williamson wrote on January 24, 1865: “The Executive Committee of Management for the Celebration of the 106th Anniversary of the birth of Robert Burns’ have instructed me as their Secretary to request the honor of your recognition of the genius of Scotland’s bard, by either a toast, a sentiment, or in any other way you may deem proper. It takes place tomorrow.” This and Lincoln’s response is from the *Collected Works of Abraham Lincoln*, Rutgers University Press, New Brunswick, New Jersey, 1953; vol. VIII, p. 237.

⁸³ Harkness, p. 34.

With his election as President, and as the nation was plunged into civil war, it was the words and thoughts of Shakespeare that increasingly supplied him with aide and comfort. In particular, it was Shakespeare's profound insights into statecraft that Lincoln drew upon and would use to organise others on the deeper meaning of the Civil War. No one else but Abraham Lincoln was able or capable of providing the leadership necessary to ensure the survival of the Nation for all Humanity. In that enormous bloody conflict which pit brother against brother, Shakespeare's tragedies were an indispensable counsel to the President.

In 1862, President Lincoln spent several days in Hampton, Virginia at Fort Monroe viewing military operations. Francis Carpenter, a portrait painter, accompanied the President and tells us of an incident that occurred at the fort:

One day (it chanced to be the day before the capture of Norfolk) he sat reading alone, he called to his aide, Colonel LeGrand Cannon of General Wool's staff in the adjoining room, – "You have been writing long enough, Colonel; come in here; I want to read you a passage in *Hamlet*." He read the discussion on ambition between Hamlet and his courtiers, and the soliloquy, in which conscience debates of a future state. This was followed by passages from *Macbeth*. Then opening to *King Lear* he read from the third act the passage in which Constance bewails her imprisoned, lost boy.

Closing the book, and recalling the words, –

*And father Cardinal, I have you say
That we shall see and know our friends in heaven:
If that be true, I shall see my boy again; . . .*

Mr. Lincoln said: "Colonel, did you ever dream of a lost friend, and feel that you were holding sweet communion with that friend, and yet have a sad consciousness that it was not a reality? – just so of my boy Willie." Suddenly overcome with emotion, he put his head down on the table and wept.⁸⁴

There are numerous stories of Lincoln's love of Shakespeare and his public recitations. John Hay, the President's personal secretary, recorded that:

"He would read Shakespeare for hours with a single secretary for audience. The plays he most affected were *Hamlet*, *Macbeth*, and the series of the Histories; among these he never tired of *Richard II*. The terrible outburst of grief and despair into which Richard falls in the third act had a peculiar fascination for him – 'For God's sake let us sit upon the ground/And tell sad stories of the death of kings!'"

In a 1863 letter written to actor James H. Hackett, whom Lincoln had seen perform as Falstaff (his favorite Shakespearian character) in *King Henry IV*, Lincoln references

⁸⁴ *Six Months in the White House* by Francis B. Carpenter, Hurd and Houghton, 1869. While at the White House he painted the *Emancipation Proclamation* which hangs in a staircase of the U.S. Capitol. William "Willie" Wallace Lincoln died of typhoid fever on February 20, 1862.

those plays of Shakespeare which he most often read: “*Lear*, *Richard Third*, *Henry Eighth*, *Hamlet*, and especially *Macbeth*. I think nothing equals *Macbeth*. It is wonderful.” Lincoln’s attention to *Richard III* and the other Shakespearean histories that deal with the “War of the Roses” (the English Civil War) is its obvious implications for the U.S. Civil War. Lincoln’s focus on *Macbeth* goes much deeper than historic parallels to the histories. An important insight into this is provided by the Marquis de Chambrun, who travelled with the President and friends to receive a personal report from General Ulysses Grant concerning the surrender of the Confederate Army:

“On Sunday, April 9th, we were steaming up the Potomac. That whole day the conversation dwelt upon literary subjects. Mr. Lincoln read to us for several hours passages taken from Shakespeare. Most of these were from *Macbeth*, and in particular the verses which follow Duncan’s assassination. I cannot recall this reading without being awed at the remembrance, when Macbeth became King after the murder of Duncan, he fell prey to the most horrible torments of mind.

“Either because he was struck by the weird beauty of these verses, or from a vague presentiment coming over him, Mr. Lincoln paused here while reading and began to explain to us how true a description of the murderer that one was, when the dark deed achieved, its tortured perpetrator came to envy the sleep of his victim; and he read over the same scene.”⁸⁵

Shakespeare’s *Macbeth* takes place in Scotland. As all great poets of tragedy have done, Shakespeare deliberately distorts the actual historical figures and sequence of events in order to focus on the real subject matter – statecraft – and the republican idea of the role of the individual (i.e. his audience) in changing history. The English bard was not unaware that he had reversed the true historically figures of Duncan and Macbeth.

The plot of the play, involves the great warrior Macbeth whose leadership vanquished the rebel forces attempting to overthrow King Duncan. During his return, Macbeth meets three witches who foretell that he will become the “Thane of Cawdor,” and then “King of Scotland.” Upon entering Duncan’s camp, Macbeth is declared “Thane of Cawdor” and begins ruminating over the prophecy of the witches. He and Lady Macbeth under take a plot that murders King Duncan.

The reason why Lincoln was attracted to this play is provided by Gerry Rose in his discerning article *Lincoln: Shakespeare’s Revenge*.⁸⁶

“Once Macbeth, the great war hero, commits this act of treason, the logic of his situation is such, that each horrific act, one after the other, leads to the next, until he finally murders Banquo, his best friend, and then attempts to kill Banquo’s son. Next he kills Duncan’s heirs, Malcolm’s whole family: wife, children, and all, and embroils Scotland in a civil war.

⁸⁵ Harkness, p. 32.

⁸⁶ This is an excellent treatment of Lincoln’s relationship to Shakespeare, which appeared in the American Almanac of *New Federalist*, November 22, 1999.

“For Lincoln, there is no doubt that treason is not usually the act of purely evil men, but once treason is committed, it follows completely logically that to maintain usurped power, leads men to one heinous act upon another, such that they become monsters, they do not even recognize themselves.

“This, too, was Lincoln’s critical insight into the Claudius soliloquy from *Hamlet*, in which Claudius, King of Denmark, who had killed Hamlet’s father and married Hamlet’s mother, is begging God for forgiveness.”

Confronted with treason against the United States of America, Lincoln understood that the failure to uphold the law of the Constitution would, in its inevitable logic, lead the nation down the road to Hell. Though Lincoln developed the means necessary to achieve victory for the Union, sometimes knowing that thousands would die, he did so with a ponderous compassion that came from an understanding that the U.S. Civil War was being fought over the idea of the “true nature of Man.” That is abundantly clear in examining the ‘Great Emancipator’s’ solution to what he knew had to be the reconciliation of the nation. Abraham Lincoln’s Second Inaugural Address, itself a work of art, stated this beautifully:

“With malice towards none, with charity for all, with firmness in the right as God gives up to see the right, let us strive on to finish the work we are in, to bind up the nation’s wounds, to care for him who shall have borne the battle and for his widow and his orphan, to do all which may achieve and cherish a just and lasting peace among ourselves and with all nations.”

This directly reflected the principle of the Peace of Westphalia, the 1648 treaties which ended the religious warfare of the Thirty Years War and the Eighty Years War, when civilisation demanded a policy of the “benefit of the other” and an end to those based on revenge. It is the idea Lincoln found in Robert Burns:

That Man to Man, the world o’re,
Shall brothers be for a’ that.

Emblematic of Lincoln’s thinking was the event witnessed on April 9, 1865, when news from General Grant had reached Washington that General Lee had surrendered his Confederate forces at the Virginia courthouse in Appomattox. A crowd of anxious citizens had gathered outside the White House demanding to hear from the President. Lincoln appeared from a second story window to tell them that he would present a public statement the following night. Then, noticing that the Army’s quartermaster band was in attendance, he instructed them to play *Dixie*, the unofficial anthem of the Confederacy.

This is the kind of political approach that is urgently required now to generate a ‘Dialogue of Cultures,’ rather than the insane pursuit of a ‘Clash of Civilisations’ which Dick Cheney and his British backers are so desperate to ignite in the Middle East.

Today, if you take a walk through the Old Calton Hill Burial Ground in Edinburgh (on the same hill where a monument was erected to Robert Burns) you will see the Emancipation Monument. It was erected in honour on the Scots who died fighting for the

Union in the U.S. Civil War, and depicts a freed slave with the towering figure of Abraham Lincoln. Ironically, in a strange work of fate, the burial site of David Hume (his monument appropriately being a hollow, stone tower) is adjacent to that of Abraham Lincoln, upon whose visage he will justly view for eternity.



*The Emancipation Monument in the Old Calton Hill Burial Ground
Edinburgh, Scotland*

“It is for the living, rather, to be dedicated to the great task remaining before us – that from these honored dead we take increased devotion to the cause for which they gave the last full measure of devotion – that we here highly resolve that these dead shall not have died in vain – that this nation, under God, shall have a new birth of freedom – and that government of the people, by the people, for the people, shall not perish from the earth.”

– Abraham Lincoln; Gettysburg, Pennsylvania November 19, 1863

C. A Proposal for the Economic Development of Scotland

By the mid-18th century, the American colonists formed the most highly literate citizenry in the world; the standard of living was then the highest in the world.

Such economic and intellectual growth threatened the British Empire. America was to be a mere raw materials-producer, devoid of manufacturing industries. To that end, the British attempted to outlaw manufacturing industries; and they did outlaw the issuance of sovereign currency, and imposed crippling taxes.

As agent for the British East India Company, Adam Smith, in *The Wealth of Nations* (which should have been more accurately entitled "How to Steal the Wealth of Nations"), argued for keeping America, and other nations, from developing industry. Smith argued that the colonies should produce raw materials for the "workshop of the world", i.e. England, and buy their manufactured goods from operations based in England.

This system of imperial monopoly on manufacturing, Smith called "free trade." He said any attempt to create manufacturing in an "agrarian country" was "artificial," and thus more expensive. Therefore, no tariff barriers or other incentives to domestic manufacturing should be allowed.

This, of course, meant that raw materials would be shipped to Great Britain, at whatever price London was wont to pay. When the Americans tried, for instance, to manufacture iron, London dumped great quantities of iron on the colonies; when virtually all the American foundries had been driven out of business, London jacked up the prices.

Today, as Scottish industry disappears, London demands that Scotland provide water and natural gas for English consumers. As the Dounreay nuclear power plant is shut down, the taxes of Scots go up.

Not too long ago, Greenock boasted one of the most advanced and productive shipyards in the world. Those shipyards now stand idle. East Hamilton St., where thousands of workers once congested the local auto traffic as they walked to and from the shipyard gates, is now the site of such non-productive enterprises as supermarkets and housing.

The Industrial Clearances

Under the slogans of "privatisation", "post-industrialism", and "over-supply", the London-based financial interests have bulldozed Scotland's industry. The 1740s Clearances of Robert Dundas were acts of enlightened beneficence by comparison.

The selling-off of Scotland's industrial potential is not unique. The United States of America and the nations of Western Europe have all been victims of looting operations by the same or related financial institutions.

Millions of people are starving throughout the world. Yet, we are told that American, Australian, and Western European farmers "over-produce." As the infrastructure of Scotland and the rest of the world collapses, Ravenscraig steel complex and the deep-water terminal at Hunterston peninsula are shut down. London and the executives of British Steel claim "over-supply" in the steel markets.

Scots have been targets of an unending propaganda campaign, alleging that there is no need for heavy industries such as steel, manufacturing, nuclear power, and shipbuilding. Instead, they are told, Scotland needs only light industries and "service industries" to enter the "information society" and "post-industrial" utopia.

To shut down such facilities as Ravenscraig is economic suicide. There is no advanced industrial nation without a modern steel industry. Man can not live by computer chips alone.

The "American System" of economic progress

Though the Americans formally won their independence when the British Army surrendered at Yorktown in 1781, they did not obtain that independence in fact, until the economic measures proposed in the early 1790s by America's first Secretary of the Treasury, Alexander Hamilton were put into effect.

In three reports to Congress in 1790 and 1791, the Report on Public Credit, the Report on Manufacturers, and the Report on the National Bank, Hamilton elaborated what he called, "the American System." He emphasized the following:

- (1) that true wealth lay in the development of the creative powers of mankind, not in mere objects per se;
- (2) the founding of a national bank to foster the growth of manufacturing and agriculture;
- (3) the creation of a national infrastructure grid of roads and canals;
- (4) the erection of a tariff system to protect domestic manufacture;
- (5) a system of universal public education to create both a politically responsible, highly qualified work force and citizenry.

The American System stood in stark contrast to what was called in the 19th century "British System." The latter was built upon usury, free trade, slave labour, and opium.

Hamilton's idea of wealth was quite different from that of Adam Smith. In his 1790 "Report on a National Bank" to the U.S. Congress, Hamilton stated:

"It is in material what serves the purpose of money, whether paper, or gold and silver; that the effect of both upon industry is the same; and that the intrinsic wealth of a nation is to be measured, not by the abundance of the

precious metals contained in, but by the quantity of the products of its labor and industry."

In his later "Report on the Subject of Manufacturers," Hamilton locates the primary generation of wealth in the creative potential of the population, demonstrated through the increase of production via science and technology.

The theorists of the American System were Alexander Hamilton; Mathew Carey, an Irish republican and collaborator of Benjamin Franklin whom the British had exiled; his son, Henry Carey, who was Abraham Lincoln's leading economic advisor; and a German, Friedrich List, who studied in America and created the German Zollverein (customs union) and the first German rail network. Today, the principal advocate of the American System is the economist and statesman Lyndon H. LaRouche, Jr.⁸⁷

The Financial Crash

As of August 2007, the biggest financial bubble in all history had begun to burst. In principle, the present bubble is a copy of the famous Tulip bubble of the 17th century, and the two South Sea Island/John Law bubbles, which bankrupted England and France during the early 18th century. It is more deadly than the Venetian debt-bubble which plunged 14th century Europe into a "dark age,"⁸⁸ since the present bubble is global and far deadlier than anything previous.

Seven years ago (October 1999), there was approximately \$300 trillion dollars equivalent of short-term liabilities on the international markets. Against that, the security for this bubble was about \$41 trillion in total Gross Domestic Product, calculated in dollars, of the entire global system. Today, it is several orders of magnitude beyond the collective physical GDP of global production. The current crisis is systemic.

Under the rubric of "globalisation," the bubble has become hyper-inflated to the point that the international hedge funds have gobbled up the private, national and provincially (state) chartered banks, which now do their bidding. The managers of these hedge funds are quite literally the modern 'Pirates of the Caribbean.' About 80% of the world's hedge funds are registered in the British Overseas Territory of the Cayman Islands.⁸⁹

⁸⁷ On the American System of economics, see Lyndon H. LaRouche, Jr., *So, You Wish To Learn All About Economics?*, New Benjamin Franklin House Publishing Company, New York, 1984.

⁸⁸ See "[How Venice Rigged the First, and Worst, Global Financial Collapse](#)" by Paul Gallagher, *Fidelio* magazine, Vol. IV, No. 4, 1995.

⁸⁹ At the end of 2006, the Cayman Islands were the home for over 8,000 hedge funds. While its banking system held \$1.4 trillion in deposits (making it the fourth largest banking center in the world (after the U.S., Japan, and Britain), its holdings for insurance operations of the more speculative assets of the insurance sector is about \$30 trillion.

The graph below (*Figure 1*), illustrates the famous “Triple Curve” developed by Lyndon LaRouche in 1995, which demonstrates the nature of the international financial crisis. It depicts a “typical collapse function”, showing the current hyperbolic rate of growth of financial and monetary aggregates, and the corresponding decline of physical production.

Figure 1

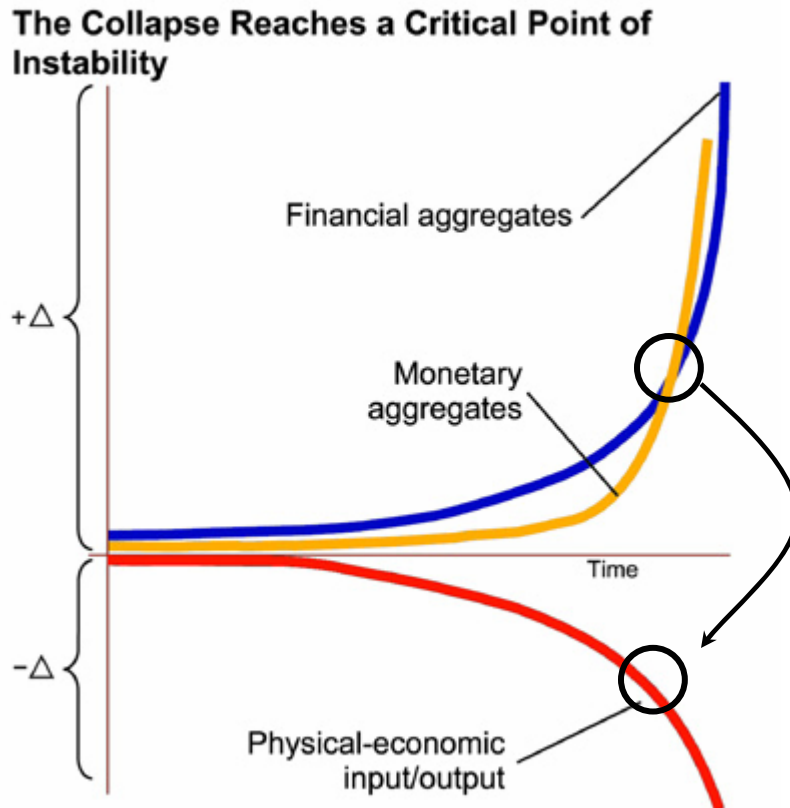

LaRouche describes his Triple Curve:

“Three variable magnitudes are depicted, each measured per capita of population. The top-most, up-sweeping curve represents financial aggregates, including what are called ‘derivatives.’ The middle, more slowly up-sweeping curve, corresponds to monetary aggregates, approximately equivalent to U.S. M-3. The lowest, down-sweeping curve, corresponds to physical market-basket magnitudes. The chart depicts the underlying trend in, chiefly the U.S.A., western Europe, and Japan economies, combined for the interval, to the present, beginning 1966-1967, a beginning-point intersecting the November 1967 devaluation of the British pound, and the ensuing IMF crisis-actions of March

1968, which prefaced the August 1971 break-up of the old Bretton Woods system. The right-hand side of the figure represents the presently ongoing, terminal phase of the present international monetary system, which began during October 1997. The nearly vertical rise of the top-most curve, 'financial aggregates,' at the right-hand side of the figure, anticipates the hyperinflationary breakdown process, which erupted in August 1998, and has been ballooning since, bringing us now toward either the deepest economic depression of the Twentieth Century, or a global, or nearly global, Weimar-hyperinflationary disintegration of the U.S. Dollar, the British Pound, the Japanese Yen, and the virtual still-born Euro, during the near future – unless the type of new monetary and financial system which I have prescribed is pushed through during the immediate future."⁹⁰

The European Productive Triangle & the Eurasia Land-Bridge

In late 1989, during the upheavals which brought down the Berlin Wall and freed much of Eastern Europe from Communist rule, Lyndon LaRouche put forward a proposal to rebuild the European economy, especially of those nations that were formerly part of the Soviet Union.⁹¹ This he called the European Productive Triangle, referring to the idea of building a new transport infrastructure for Europe, with the latest railroad, power, and water transport technologies, centred upon the triangular area between Berlin, Paris, and Vienna (*Figure 2*). The area of the triangle is approximately 320,000 square kilometers -- around the same area as that of Japan -- with almost 92 million human beings. It has the greatest density of industrial infrastructure and highest standard of education and culture. The Productive Triangle proposal was to become the motor for re-industrialising Central and Eastern Europe and beyond. The "spiral arms" of the Productive Triangle would radiate out towards North Africa, the former-Soviet Union and Asia, creating a New Silk Road. Its central feature was high-speed rail routes as seen in *Figure 6*. Such a rail system would allow passengers or cargo from Scotland to travel to Tokyo, New Delhi, Beijing, or Vladivostok at a speed of 300 miles per hour. With a rail link across the Bering Straits (*Figure 13*), the subject of a recent international conference in Moscow,⁹² one could board a train in Edinburgh and get off in New York City!

⁹⁰ Lyndon H. LaRouche, Jr., *The Road to Recovery*, LaRouche's Committee for a New Bretton Woods, Leesburg, Virginia, 1999, p. 108.

⁹¹ *Can Europe Stop the World Depression?*, Special Report by Executive Intelligence Review (EIR), Washington, D.C., 1991.

⁹² This historic conference, sponsored by the Council for the Study of Productive Forces, a joint research organization of the Russian Academy of Sciences and the Ministry of Economic Development and Trade, was held on April 24, 2007. Participates included a number of prominent Russians academicians, Helga and Lyndon LaRouche, and Walter Hickle the former Governor of Alaska. The proceedings were published in the Russian journal [International Forum](#) (in English and Russian) and are available on the

It must be noted that, if the Productive Triangle had been adopted at that time, East/West relationships would currently be based on a new geometry of development of the physical economy, rather than the Free Trade looting and increased instability that has led us to the current bankruptcy of the international financial system.

In 1997, Lyndon LaRouche and his associates at Executive Intelligence Review issued an in-depth, special report – *The Eurasian Land-Bridge; The ‘New Silk Road’ Locomotive for Worldwide Economic Development* – conceived of as a blueprint for worldwide development. The Chinese government has adopted the programme of the Eurasian Land-Bridge as its long-term policy for China. A significant amount of construction has already occurred, primarily in China and adjoining nations. Likewise, President Putin decided in April of this year to make railway development a priority for Russia. Much more work, of course, lies ahead.

Figure 7 shows the Eurasian/Africa map of the main transportation corridors that appeared in that EIR Special Report, and *Figure 8* is a map of the projected global infrastructure projects and routes that would connect the majority of the world’s population.

Figure 2 **The European “Productive Triangle”**

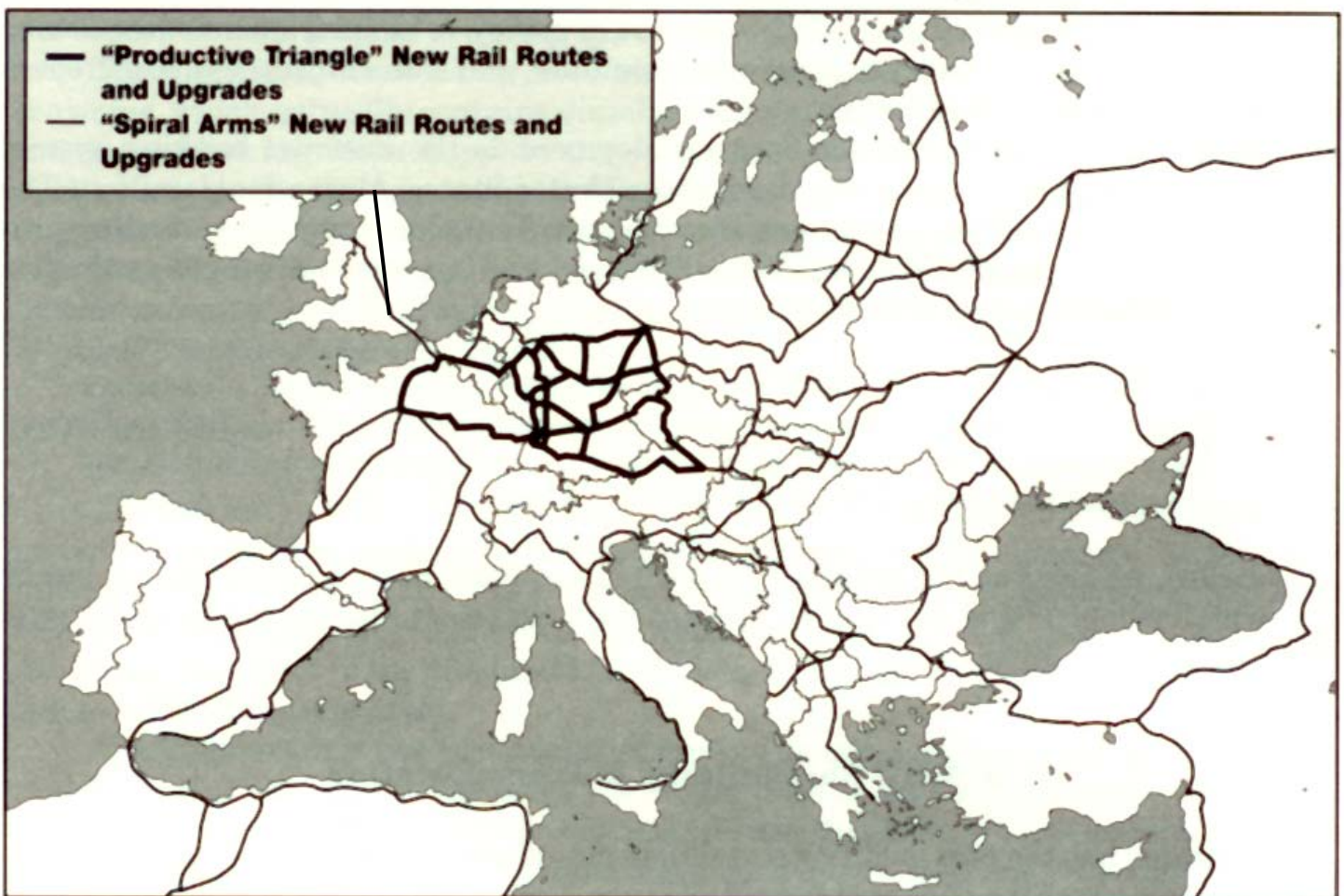

AN ECONOMIC PROGRAMME FOR SCOTLAND



I. The National Bank of Scotland

A national bank dedicated to fostering the nation's physical economy is the cornerstone of sovereignty. Without such an institution, any talk of economic recovery is but idle chatter.

The establishment of a National Bank of Scotland would be a means, not just for issuing currency, but for putting national currency, legal tender, out as loans at very low interest rates.

The magnitude of such loans would be in the order of several £ billion a year for public works, and a comparable amount to the private sector for investment, primarily in employment in high-technology and heavy engineering.

The interest rates on such loans would be between 2% and 4%. How would the money be paid back? Through increased tax revenues as a result of the activity so generated.

Where will the money come from to finance Scotland's development? Money is never the problem: It is only paper. In a sovereign nation, the monetary system is the

creation of the state, which regulates and directs the use of money as an instrument of the *labour power* of the nation, its ability to generate, assimilate, and transmit successive increases in the rate of technological progress.

The chief monetary tool for such development is the national banking system pioneered by the first Treasury Secretary of the United States, Alexander Hamilton. The National Bank introduces new issues of currency into the economy, by extending low-interest credit exclusively for technologically progressive investments into the productive sectors of the economy. Hamilton wrote:

"The tendency of a national bank is to increase public and private credit. The former gives power to the state for the protection of commerce among individuals. Industry is increased, commodities are multiplied, agriculture and manufactures flourish, and herein consist the true wealth and prosperity of a state."⁹³

Below, we focus on the priorities for such investment, limited not by money, but by the available labour and physical equipment that can be set into motion by issuance of National Bank or other credit.

II. MHD Shipbuilding & Transportation

Scotland has the port facilities and skilled manpower to design and build the ocean-going technology of the 21st century: MHD-propelled ships.

In 1992, reports of the Japanese-built ship, *Yamato 1*, put MHD, or magnetohydrodynamics, into the headlines of the world press. The 98-foot prototype is propelled by two MHD thrusters that run without any moving parts. When developed, a MHD ship will be able to attain speeds of more than 100 knots, 125 miles per hour, with little noise. This is several times the 30 to 35-knot top speed of today's ships, which are slowed by turbulence (cavitation) produced by the ship's propellers.

How MHD Works

Magnetohydrodynamics describes the interaction of magnetic and electrical fields. When a magnetic field is applied perpendicular to an electrically conducting fluid, an electrical potential is produced perpendicular to both the magnetic field and the fluid flow (*Figure 3*). The work of a MHD generator is performed by the conducting fluid, which produces an electrical current without the moving parts used in today's steam

⁹³ Henry Cabot Lodge, ed., *Collected Works of Alexander Hamilton*, letter from Hamilton to Morris, 1781.

turbine generators. The wasted energy of rotating huge pieces of equipment is eliminated, along with the excess noise and heat.

The electrically conducting fluid for a MHD system can be the high-temperature combustion products of any fossil fuel, a liquid metal, the charged particles from a thermonuclear fusion reactor, or any other ionized material. MHD can be applied to small systems, such as portable power supplies, or to the largest electric-generating plants.

As the electrical potential is produced in the MHD channel, the temperature and velocity of the working fluid drop. However, by turning this process around, applying electricity to an electrically conducting fluid surrounded by a magnetic field, the velocity of the fluid increases. This is the principle of the propulsion technology demonstrated by the Japanese ship *Yamato 1*, during sea trials in June 1992.

The electrically conducting fluid used in the MHD thruster of the *Yamato 1* is seawater, which naturally contains dissolved salts. A set of dipole magnets surrounding the duct of flowing water supplies the vertical magnetic field, and when a current is applied across the flowing water, it is accelerated. Current to maintain the vertical magnetic field and the electric current between the two electrodes in the seawater duct is produced by a diesel generator. Forward thrust for the ship is produced when the faster flowing seawater is pushed out the stern, just as forward motion is produced when air is quickly let out of the open end of a balloon.

MHD for Ships

The interest in MHD to propel ships goes back to the 1960s. Replacing conventional propeller systems has been important to military designers of submarines, as portrayed in the popular motion picture *The Hunt for Red October*. For commercial shipping, MHD propulsion increases speed to about 125 miles per hour. At that speed, the ferry from Aberdeen to Lerwick in the Shetland Islands, which now takes 14 hours over the 95 miles, will take less than one hour.

The *Yamato 1* has two identical thrusters (*Figure 9*). The thrusters are located on both sides of the stern of the ship, well under the water level to lessen turbulence. The design specifications for the test ship required that the two thrusters provide enough motion to propel the ship at 8 knots. The ship is 98 feet long, holds 10 crew and passengers, and has a gross weight of 280 tonnes. The *Yamato 1* reached a speed of 7.5 knots during its test runs, very close to specification, and cleared the way for the construction of *Yamato 2*, which would be larger and capable of faster speeds.

The Japanese have also worked on a submersible version of a MHD-propelled ship to carry freight. At a depth of 50 to 100 feet below the surface, drag is reduced and there are no weather constraints. This would allow ships to transport at high speeds perishable and high-value cargo, which today is carried by airplanes at great cost. Such vessels would be of special interest to Scotland, given her turbulent seas.

Though there are technological obstacles to overcome for large-scale MHD shipbuilding, the Yamato 1 has demonstrated that magnetohydrodynamic propulsion will revolutionise ocean transportation. Moreover, the Japanese MHD project has also pushed forward the state of the art in superconducting technology, ship design and materials, and MHD direct conversion to electricity, which will have many other applications.

Unfortunately, the Japanese MHD project for ship propulsion has become yet another victim of globalisation. Construction of the Yamato 2 was terminated, while the Yamato 1 became an artifact at the Maritime Museum in Kobe, Japan. None the less, the scientific principles for this technology have been proven, and must be vigorously pursued.

Figure 3

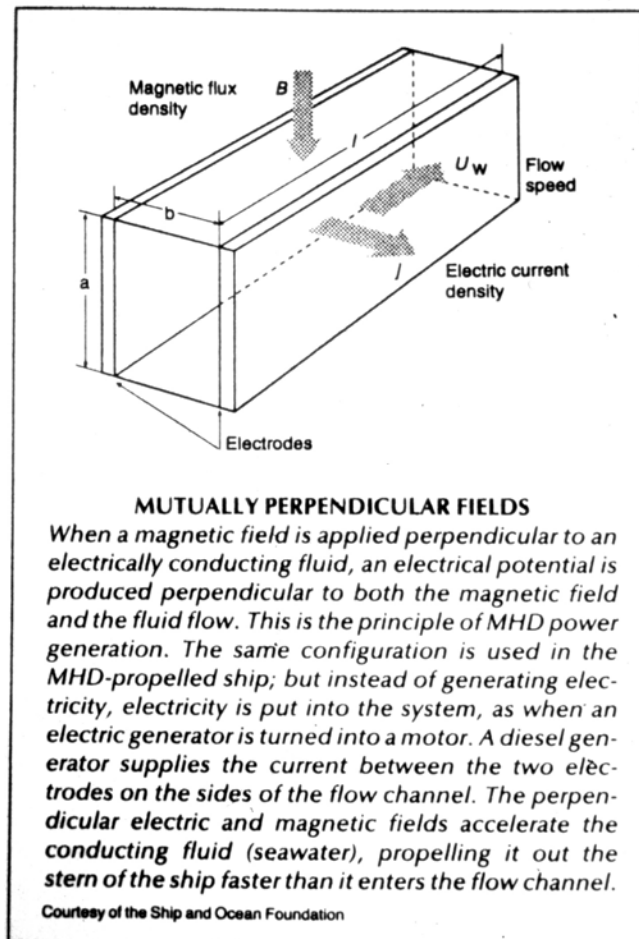

What Must Be Done

The first order of business is to reopen Scotland's shipyards. While MHD shipbuilding will be phased-in over the coming years, Scotland must meet current demand for ferry construction and maintenance.

A task force of Scottish scientists, engineers, entrepreneurs, and labour leaders should be established to develop a Scottish National MHD Project, a crash programme of the highest national priority, involving research and development, as well as the mobilisation of manpower, and physical plant and equipment.

This will mean expanding existing manufacturing facilities and establishing new ones to supply high-technology electronic components, super-conductive technology, and advanced materials development and processing. Concentration on these key industries will not only allow for MHD-shipbuilding, but will also generate the means to build high-technology exports.

LaRouche on Scotland and MHD Shipbuilding

"In Scotland, we have people who have some education, some training, some skills, and contrary to the popular delusion, we have a great shortage of skilled labour power in the world today. Scotland also has, and should have more infrastructure. If you wanted to stick some industries in there to produce things, and produce not with some foolish free trade theory but in real terms, you would say that an area like Scotland is needed.

"First, we have a great advantage. Let's take two points of reference, because of the relationship to sea travel: the Edinburgh area and the Glasgow area. We can produce today, or will be able to produce very soon, sea-going craft powered by electrodynamic use of water i.e., forms of propulsion which take seawater passing through a tube or something, acted on by electromagnetic fields, with a number of superconductivity magnets, which will move freight very efficiently and at very high speeds. So, if I could produce something near the coast of Scotland, and most of Scotland is near the coast someplace, get it to a port, we can move products, particularly high-tech products, at a greatly advantageous price, because of the economies of sea-transport. High-speed ocean travel brings ocean travel back into balance again. The problem in Scotland is not to wait for the thing to happen. We need to have a movement there which is determined to see this happen on the continent, and to marshal the development of Scotland itself, in terms of infrastructure and industry, to take advantage of the natural advantages which Scotland will have in terms of its population and in terms of its position for participating in certain aspects of the industries."

Excerpt from an interview given by Lyndon LaRouche on February 6, 1993 to *Scolag*, a Scottish legal news bulletin.

III. Steel Production

Restarting and modernising the steel industry, is critical to the re-opening of the shipyards and MHD-shipbuilding.

A Scottish National Steel Company should be established, to purchase the Ravenscraig steel complex and the Hunterston Peninsula facilities from British Steel (now operated by Clydeport which is owned by the Peel Group).

In the event British Steel refuses a reasonable offer, since these facilities are of strategic interest to Scotland, the facilities could be expropriated in the same manner that U.S. President Harry Truman ordered the Secretary of Commerce to "take possession of the steel mills and to keep them operating." This is also what President Kennedy did when the major U.S. steel companies illegally conspired to raise the price of steel by some \$6 a tonne. These U.S. presidents understood that steel was a national security issue: as George Washington and other American System leaders have stated, the front line of national security is a strong economy.

With the Ravenscraig and Hunterston facilities as the cornerstone of the new Scottish National Steel Company (SNSC), the National Bank of Scotland shall issue long-term, low-interest credit to the SNSC and participating private companies, to re-open and upgrade Scotland's steel industry.

This will put 20,000 Scots back to work at Ravenscraig, Hunterston, and related industries. The deep-water port facility at Hunterston shall be upgraded with an integrated steel-making complex.

The two aluminum smelters in the Highlands at Lochaber and Kinlochleven, formerly operated by British Alcan Aluminum, shall be re-opened. The energy demands for smelting are addressed below.

Plasma Steel Production

The Scottish-born giant of the American steel industry, Andrew Carnegie, shows how Scotland's steel industry could operate. Carnegie had no respect for budgetary economics. He tore down steel furnaces and replaced them with more advanced ones, as fast as he could apply the new technology. Carnegie knew that constantly investing in improved technology increased production, thereby lowering the cost of the steel, and raising profits, wages, and the general living standard of the population. The Carnegie Era boom in U.S. steel more than tripled annual output per steel worker between 1860 and 1900.

The SNSC shall establish a research and development department.

The next step in technology is plasma steel production, which will yield much higher quality steel without the familiar smoke stacks!

Plasma, ionized matter, could be called the fourth state of matter. We see it every day in the ionized gas of neon light, or fusion which occurs on the surface of the sun.

High-quality metal alloys are made today in electric arc furnaces that operate at about 1,650° Celsius. Research in fusion energy and plasma physics over the last four decades has opened up the use of plasmas at an order-of-magnitude higher temperature; more materials can be alloyed to steel. The most advanced plasma steel-making process in the world had neared commercial demonstration almost twenty-one years ago, in the American State of New Jersey. Only the chronic under-investment in the steel industry over the last twenty-six years, and then outright destruction of capacity by the major steel producers, has prevented this revolutionary new technology from coming on line.

The plasma furnace uses a high-temperature inert gas that has been ionized, consisting of positively and negatively charged particles. At 20,000° C, no material can contain this hot gas; therefore, as in fusion energy experiments, magnets surround the furnace to hold the plasma in the shape of a cone. Pellets of the materials to be refined are dropped into the furnace from the top, and in the 0.45 second it takes the pellet to fall to the bottom of the furnace, the material has been refined. At these increased temperatures, alloys with barium and tungsten can be created. In addition to doing away with the traditional blast furnace, all smoke waste is eliminated in the plasma process. Advanced technology means increased efficiency and a cleaner environment.

Super-hard materials, such as alloys with barium or tungsten, can be used for tool steel, which cannot be cut even with a diamond. Rather than changing the tool in an automatic lathe, for example, after each eight-hour shift, this new alloy extends the life of the tool from seven to ten times. The barium and tungsten alloys can withstand temperatures up to 2,210° C, compared to the 1,650° of today's tool steels, and are oxygen-resistant.

Beyond plasma steel alloys, we should begin to examine the materials which will replace steel in the future: high-technology ceramics.

IV. A Scottish Nuclear Programme

If Scotland is to be truly independent, it must develop a comprehensive nuclear energy programme. Putting aside the political and financial intrigues of British Petroleum, and manipulation of energy resources from London, petroleum is much too valuable a commodity to be burned as a fuel. Only advanced nuclear technology can provide Scotland with the efficient, cost-effective supply of energy it will need for an expanding economy and population. A Scottish Nuclear Programme (SNP) will train Scotland's scientists and engineers for the age of nuclear fusion, a technology which will revolutionise every facet of industry from mining and chemical processing to space transport.

Recent advances in reactor design in Germany and the United States (*Figure 10*) have developed medium-sized, 135-megawatt (MW) modular HTGRs (high-temperature gas-cooled reactors), that promise to revolutionise the nuclear energy industry worldwide. The most visible difference between conventional nuclear reactors and the MHTGR is its fuel and containment design. Instead of the familiar huge, doomed

containment buildings of conventional nuclear plants, designed to protect the surrounding area from any release of radiation, containment for the MHTGR is minuscule, the size of a grain of sand. The nuclear fission reaction takes place on a very small scale; little particles of enriched uranium are encased (contained) in a ceramic sphere made out of materials developed in collaboration with the U.S. space programme. The fission power of the MHTGR comes from tens of thousands of these tiny fuel particles, each in its own "containment building."

The advantages of the MHTGR are many:

- 1) small size units (135 megawatts-electric) that can be grouped at a site;
- 2) standardized, assembly-line design features;
- 3) competitive cost (estimated to be 10-20% cheaper than current coal or conventional fission plants);
- 4) high temperature process heat or steam (550° Celsius, compared to the 300° C limit of conventional water-cooled nuclear reactors), making possible a wide range of industrial applications, from refining petroleum to making fertilizer and paper;
- 5) passive safety features (the fissile fuel is "contained" in tiny ceramic spheres and the reactor never gets hot enough to breach this containment; no meltdown is possible).

The MHTGR is also unique in the fact that new MHTGR modules can be added in stages to meet the increasing demand for electrical power. A 100 MW plant could meet the electricity needs of a city of 100,000 people. Such technology is ideal for the more isolated island communities of Scotland.

The use of gas coolant instead of water has the advantage of allowing the power plant to operate at much higher temperatures and hence greater efficiency. Efficiency is measured in terms of how completely the fuel is utilized or converted, the conversion ratio being the number of fissile nuclei formed for each nuclear fission reaction that takes place. Conventional water-cooled nuclear plants have a conversion ratio of about 32%, while the high-temperature reactors are 40% or more. With a direct cycle gas turbine instead of steam, conversion efficiency is 50% or better. Temperatures can reach 1,000° C, at which temperature they can be used for coal gasification, and thermal cracking of water to produce hydrogen as portable fuel.

The MHTGR has a new safety design. If something goes wrong with the MHTGR - for example, the highly unlikely, worst case where all coolant and control systems fail - the MHTGR fuel pellets can withstand the highest temperatures that could be generated (1,600° C). The "containment" wall of the tiny pellets would remain intact, and the reactor heat would dissipate "naturally," even with no human intervention.

The simplified safety system of the MHTG makes it inherently less costly than conventional fission plants, where safety systems account for approximately 25% of the total capital cost of the plant.

Another factor favouring the MHTGR is the speed with which it can be built. General Atomic Technologies Corporation, one of several U.S. companies involved in research and development for the MHTGR, estimates that once mass production begins, it will only take 27 months to put into power production one unit of a multi-unit MHTGR site, assuming that licensing requirements have already been met by the first prototype. Because the reactor is modular and factory produced, the site construction proceeds while the reactor components are being produced in a factory off-site. When completed, the nuclear reactor and the turbine systems can be transported from the factory by truck or rail, and dropped into the underground silos that will house them.

Given Scotland's existing port facilities and potential for deep-water port operations, the mass production of MHTGRs for export to world markets could also be considered.

V. Railroad & Airport Construction

The October 5, 1999, a head-on collision of two commuter trains, two miles west of London's Paddington Station, killed more than 30 people and injured over 160. The crash carries the label of the "Third Way," for the blame lays squarely at the doorstep of 10 Downing Street and Prime Minister Tony Blair. It was Blair who championed the policy of privatisation for rail and other infrastructure, which had been set into motion by his Tory predecessor, Margaret Thatcher.

In 1979, Prime Minister Thatcher, a devotee of the oligarchical financiers Mont Pelerin Society cult of monetarism, instituted the policy of selling off Britain's state-owned industries. Electrical power utilities, water infrastructure, British Aerospace, British Telecom (the phone company), British Gas, Associated Ports, and coal mines were sold to private financier sharks at bargain prices. Profits were then generated by looting the companies; workers were sacked, and investment into infrastructure and research and development were slashed. In the case of water, for example, people in Wales and England, who paid £65 a year for water in 1983, were paying between £108 to £350 by 1995.

Though Thatcher failed in her plan to get the Westminster Parliament to privatise British Rail, Tony Blair did succeed during 1994-96. Blair's "Third Way" policies have proven to be nothing more than draconian budget-cutting programmes in social democratic disguise. Prices have skyrocketed, services have collapsed, as more people needlessly die.

Only four months after Tony Blair took office, the Southall, London rail crash killed seven people in September 1997. Instead of taking the opportunity to reverse the privatization policies of Thatcher, Blair refused to implement the recommendations of a commission that had investigated that crash and recommended that an Automatic Train Protection system (the ATP is standard throughout Europe) for safety-braking be

adopted. Then, in 1998, Blair proclaimed his plan to partially privatise London's Underground subway system. Even after the October 5th Paddington crash, Blair continued to stick to his inexpensive and inefficient programme for the Train Protection and Warning System, which will not solve the problem.

In addition to the safety issue, the shutdown of rail lines in Scotland means that thousands more lorries will crowd the already congested roads, making goods and materials harder to obtain and more expensive.

First, privatisation must be reversed. Secondly, long-term, low-interest credit must be made available to bring Scotland's railroads into the 21st century – though in many places 20th century rail technology would be a vast improvement! This would entail the installation of the ATP system throughout Scotland, England, and Wales at an estimated cost of £1 billion.

Scotland must be integrated as rapidly as possible into the European Triangle and become the rail link between Ireland and the European Continent. The opening of the Channel Tunnel was a positive step in this direction. The Scotland/Ireland connection is the next major project (see below).

Glasgow to Edinburgh in “less than 15 minutes”

The author has campaigned for development of maglev (magnetically levitated) rail systems for thirty years. The 1996 edition of this book was the first publication in Scotland to promote the construction of a maglev rail connection between Glasgow and Edinburgh:

Rail infrastructure that is 150 years old, like that on the Glasgow-Edinburgh railway, is not "quaint." It is absurd.

Electrification of the system is long overdue. The 158 "Sprinters" shall be replaced, preferably with mag-lev passenger trains. This will guarantee a commuting time of less than 15 minutes between Edinburgh and Glasgow.

Today, “From Glasgow to Edinburgh in 15 mins” is one of the slogans of [UK Ultraspeed in its May 2007 pamphlet](#) promoting the construction of the German-based Transrapid International maglev project to connect Scotland's two major cities. All the major political parties of Scotland have displayed a positive reception to the project, and the city councils of both Glasgow and Edinburgh are backing the maglev proposal.

On December 31, 2002 the world's first commercial maglev train (built by Transrapid) undertook its successful maiden trip in China, covering the distance of almost 19 miles from Shanghai to Pudong International Airport in less than 8 minutes. On board were German Chancellor Gerhard Schröder and then Chinese Prime Minister, Zhu Rongji. Since then more than 10 million people have travelled on this maglev route.

The maglev genie is coming out of his bottle, which will mean the corollary death of the British Empire's invention of the 'Great Game' of *geopolitics*.⁹⁴ At the end of September 2007, a successful round of talks between China and Transrapid brought optimistic news that the Shanghai maglev will probably be extended 160 kilometers to connect Hangzhou. This would be a major boost for maglev development globally. Other recent developments include:

- **Japan:** On April 26, 2007, the Central Japan Railway Company announced it will replace the Takaido Shinkansen Line system, the 300 mile connection between Tokyo and Nagoya, with maglev service by 2025. This utilises the U.S. invented system of electrodynamic suspension.⁹⁵
- **Germany:** On September 24, 2007, contracts were signed to construct a Transrapid maglev connection between downtown Munich and its airport. The following week, the Chambers of Industry and Commerce of Rhein-Hessen, Frankfurt and Wiesbaden sent a joint letter to the German Ministry of Transport calling to link their two airports with maglev lines.

The completion of a new Trans-Siberian Land-Bridge with maglev technology, coupled with the Bering Strait tunnel to the U.S., will revolutionise global transportation. To get an understanding of what this means, take the example of shipping between Europe and Japan which is 12,000 miles by way of the Suez Canal (18,000 for the route around Africa). That trip takes several weeks at the cost of at least \$100 per ton of cargo (at 1-cent per ton mile). Maglev can carry cargo from Europe to East Asia in only one day. The cost of world shipping consumes about 7 percent of global oil production. Maglev can move people and cargo faster, cheaper, and with significantly less energy than traditional shipping. (*Figure 4*)

The next step will be super-speed maglev, which would enable you to travel from Los Angeles to New York City in one hour. The limiting factor for the speed of maglev trains is about 300 miles per hour, due to air drag. However, with the use of low-

⁹⁴ 'Geopolitics' was created by British Empire imperialists in response to the success of the American System of political economy over the British System of "Free Trade," exhibited at the 1876 U.S. Centennial Exposition in Philadelphia, where the British delegation reported "we are losing our former leadership and it is passing to the Americans." In response to the Americans who were exporting locomotives and other technology to Ibero-America, Russian, and China and developing the first Eurasian Land-Bridge, British 'geopolitics' sought to prevent such modernisation (as it continues to do so today) by controlling the choke-points of the world's waterways and the "Eurasian Heartland." This is what has historically been referred to as the "Great Game" of British Imperialism. See 1997 EIR *The Eurasian Land-Bridge; The 'New Silk Road' Locomotive for Worldwide Economic Development* and *The International Centennial Exhibition of 1876; or Why the British Started a World War* by Mark Calney.

⁹⁵ See [Maglev: Transport Mode For the 21st Century](#) by Drs. James Powell and Gordon Danby who invented super-conducting Maglev in 1966. This paper was submitted as a discussion document for the Schiller institute's Sept. 15-16, 2007 conference in Kiedrich, Germany, on the Eurasian Land-Bridge.

pressure tunnels, speed is virtually unlimited. Only the straightness of the tunnel and centrifugal forces become major considerations. Therefore, a super maglev trip across the United States, travelling at 2,500 mph, would take one hour. The cost would be the equivalent of about one quart of gasoline per person for the trip, compared to 100 gallons of jet fuel per person for the same trip by air. Once the maglev reaches its desired cruise speed, no energy is expended. Additional advantages include the lack of turbulence and a silent ride. The proposal of the Swiss Metro System would have maglev trains operating through the mountains in such low pressure tunnels.

The entire Scottish railway system, including the rural lines, needs to be upgraded with emphasis on freight transport. (Figures 11)

Figure 4

Passenger and Freight Vehicles on the M-2000 Guideway

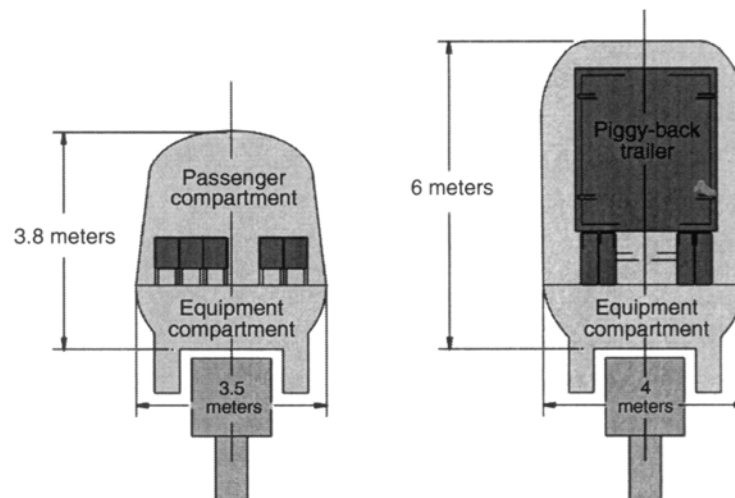

The schematic drawings show the relative size and configuration of Maglev-2000 passenger and freight vehicles.

Prestwick International Airport

Because of its relatively fog-free environment, Prestwick is an obvious choice to become Scotland main air-link to the world. Two things must be done:

- 1) The existing runways and facilities at Prestwick Airport must be expanded to handle an increased volume of international passenger and freight transport.
- 2) A high-speed rail link must be built from Prestwick International Airport to Glasgow. This, together with a modern rail network, will make Prestwick easily accessible for the major urban centres.

VI. The Thistle & Shamrock Tunnel

Now that the Channel Tunnel between England and France is fully operational, Ireland is the largest land mass in Europe to be completely surrounded by water with no railway link. To remedy that, and to serve as an economic driver for both Ireland and Scotland, a tunnel can be constructed under the North Channel from Larne, Northern Ireland (about 15 miles north of Belfast) to a site several miles north of Cairnryan, Scotland (see *Figures 5 & 14*). Though more research needs to be done, preliminary investigations for such a "Thistle & Shamrock Tunnel" shows that the North Channel is not too deep as a crossing site. The tunnel would be approximately 36 miles long, five miles longer than the Channel Tunnel.

Such a project will stimulate the economy in the region as a whole, and help to integrate Northern Ireland into the Irish Republic.

Larne is ideally situated for direct links to all the major Irish cities, via Belfast. It would, give Ireland a direct rail link to the European continent.

From Cairnryan, Scotland it is a direct run North to Glasgow, approximately 75 miles away. A railway line already exists which runs from Stranraer (a few miles south of Cairnryan) to Glasgow. Modern railway lines along this route would have to be built. Prestwick would be right on this line. The Scottish ports of Cairnryan and Stranraer currently handle ferries to Ireland and the Isle of Man.

The old "Paddy Line" from Stranraer to Dumfries, torn up by land speculation, will need to be replaced by a more modern line, probably along a different and more efficient route. This "New Paddy Line" will then be connected to existing railway lines that go on from Dumfries to Carlisle, and then on to any English city or, to the Channel Tunnel and Continental Europe.

Figure 5

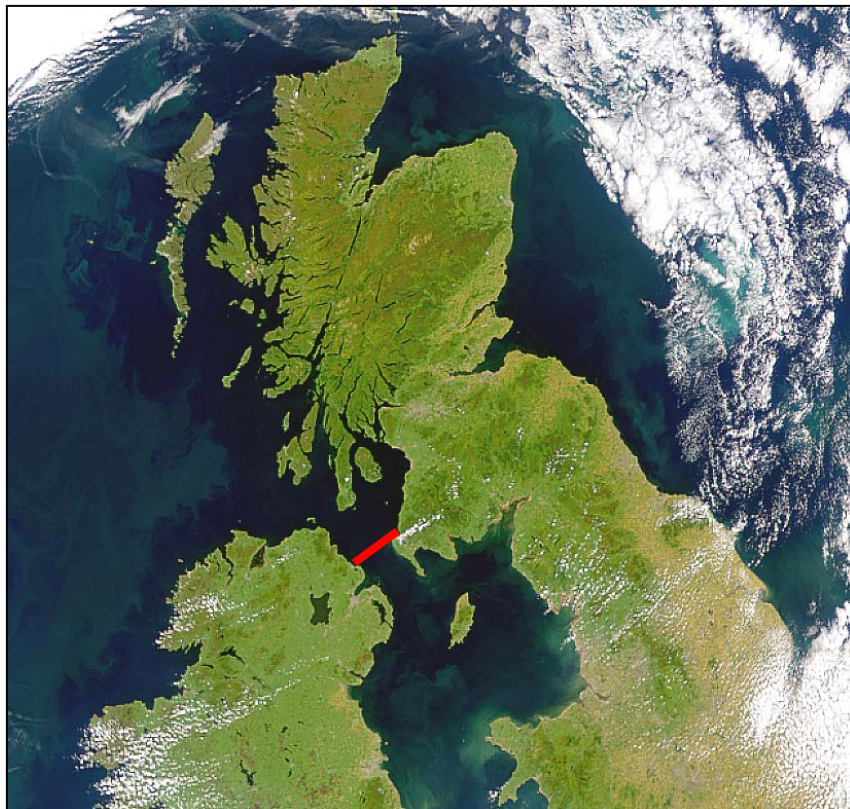

Proposed route for the 'Thistle and Shamrock Tunnel'

Figure 6 The European side of the New Silk Road



Figure 7

Eurasia: main routes and selected secondary routes of the Eurasian Land-Bridge

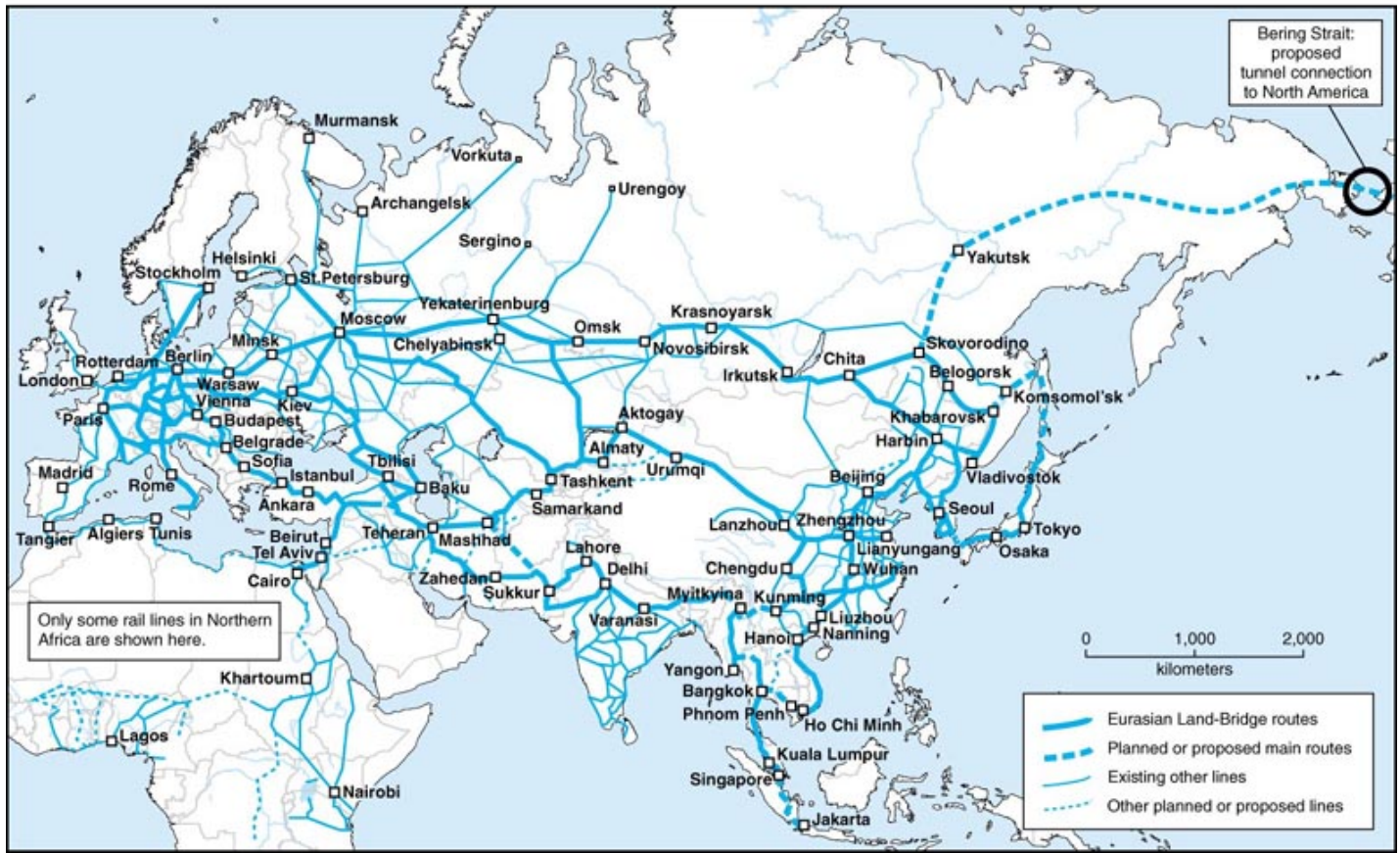

Figure 8

Global Infrastructure Projects that will connect the World by Railway

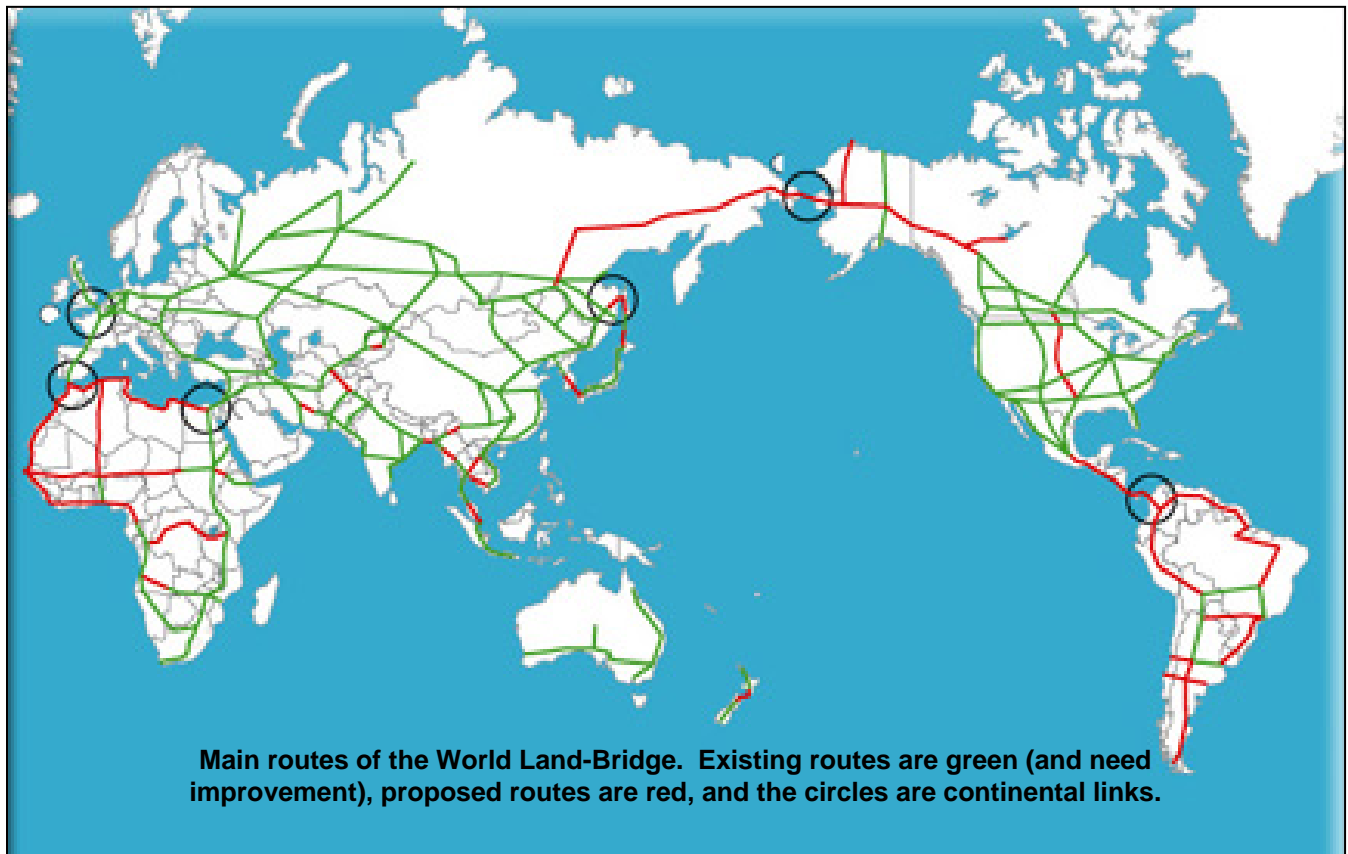
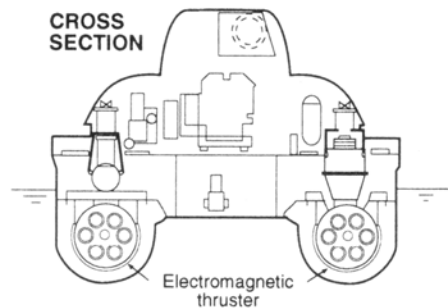
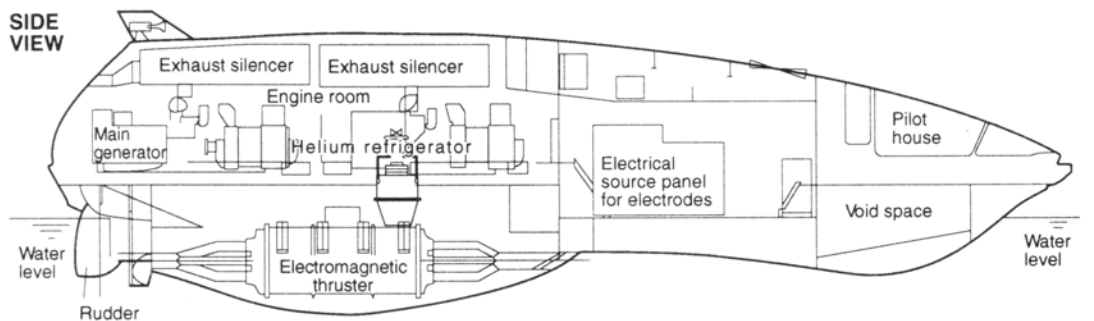

Figure 9 Yamato 1 with sectional view



SECTIONAL VIEW OF THE YAMATO 1

The Japanese MHD-propelled ship is 98 feet long, holds 10 crew and passengers, and has a gross weight of 280 tons. Twin MHD thrusters provide enough power to propel the ship at 8 knots. Future models are expected to reach speeds over 100 knots.

Figure 10 Gas turbine and helium reactor

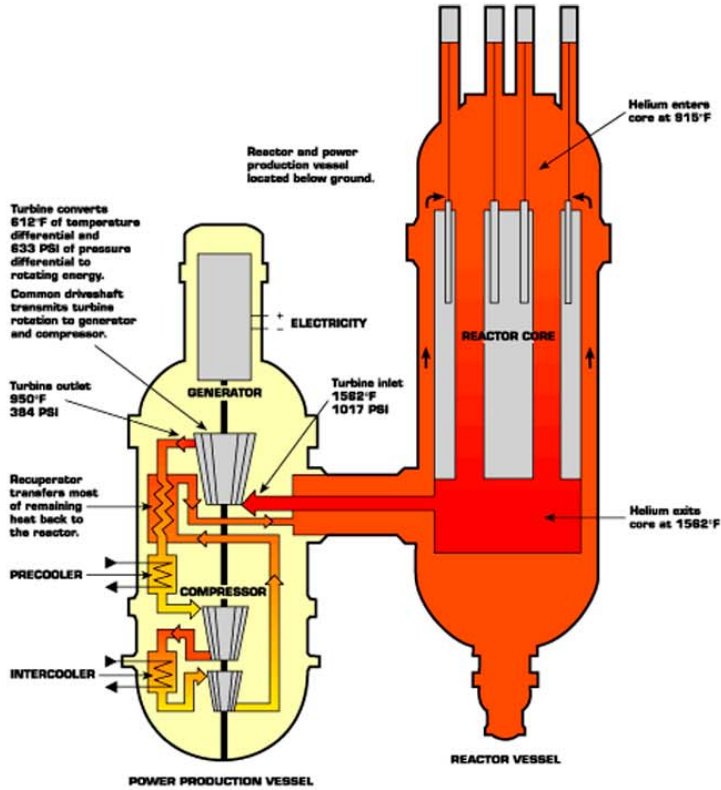

Schematic flow diagram

On the left is the power production vessel and on right is the reactor vessel

MULTIPLE LAYERS OF TOUGH, HIGH TEMPERATURE TOLERANT PYROLYTIC CARBON AND SILICON CARBIDE CONFINE THE RADIOACTIVE FISSION PRODUCTS AT THEIR SOURCE, IN THE CENTER OF THE FUEL PARTICLE.



Coated fuel particles (top) are formed into fuel rods (right) and inserted into graphite fuel elements (bottom)

These diagrams are a courtesy of General Atomics

Figure 11 Magnetic levitated train

Electromagnetic Suspension

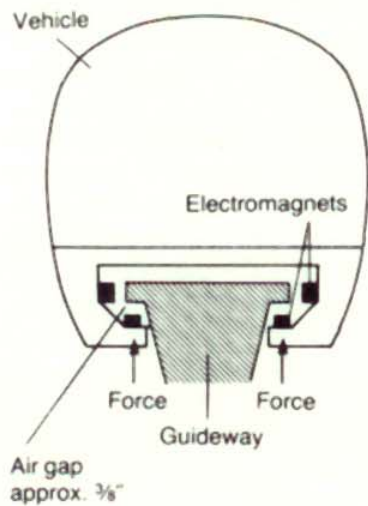

Electrodynamic Suspension

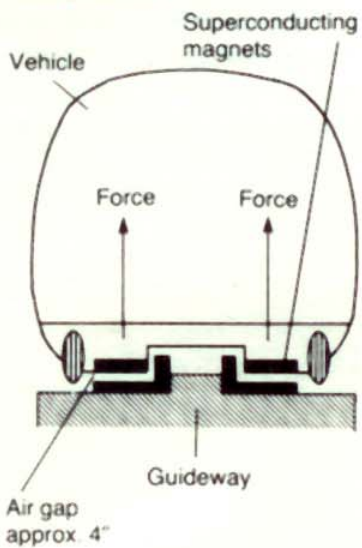

Three Generations of Rail Transport

to 90 mph: steam

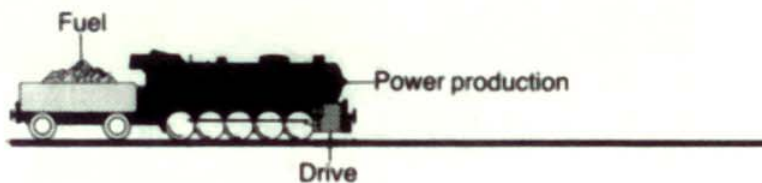

to 180 mph: electric

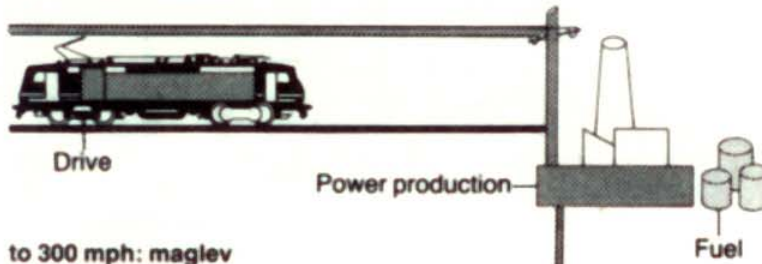

to 300 mph: maglev



Figure 12



The world's first operational maglev train built in Shanghai, China by Transrapid of Germany. It travels nearly 19 miles between Pudong International Airport and Shanghai in 7 minutes and 20 seconds. It started commercial operation on December 31, 2002 and has reached a top speed of 311 MPH.

Figure 13

ARTIST'S CONCEPTUAL VIEW OF THE NORTH AMERICAN ENTRANCE TO THE BERING STRAIT RAIL TUNNEL

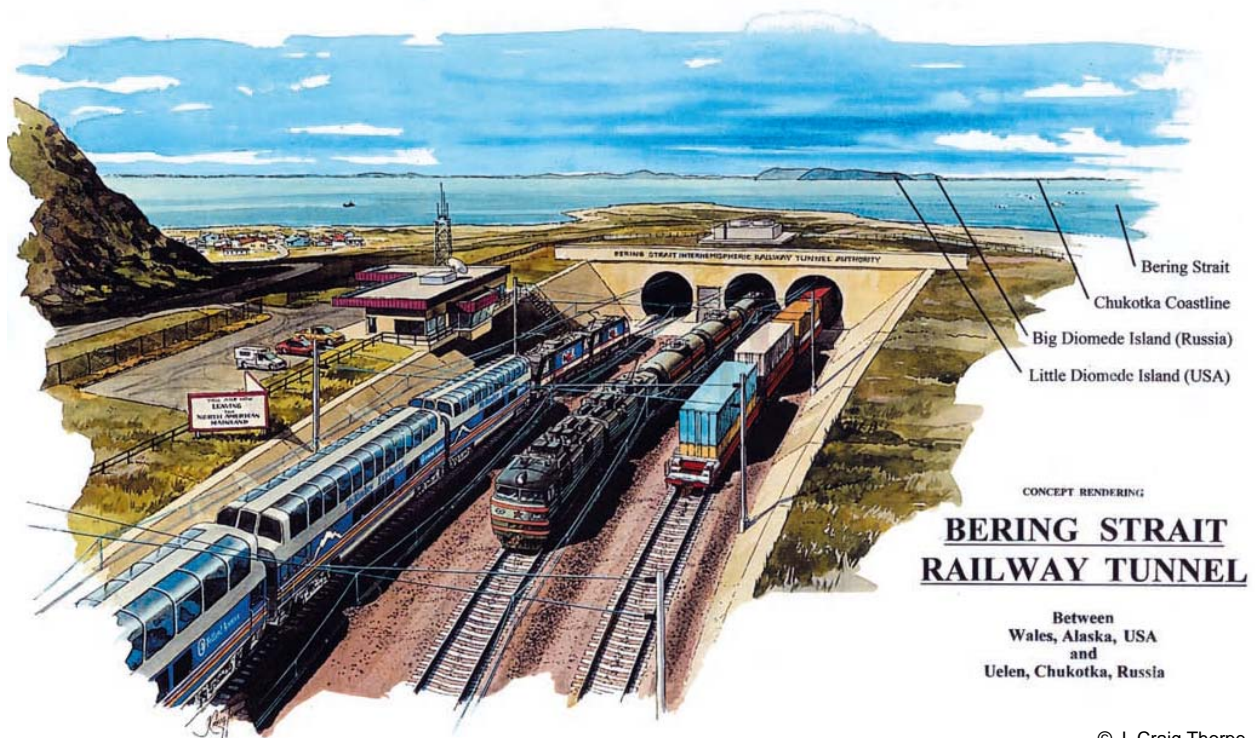

© J. Craig Thorpe

Figure 14 **The 'Thistle & Shamrock Tunnel' under the North Channel**

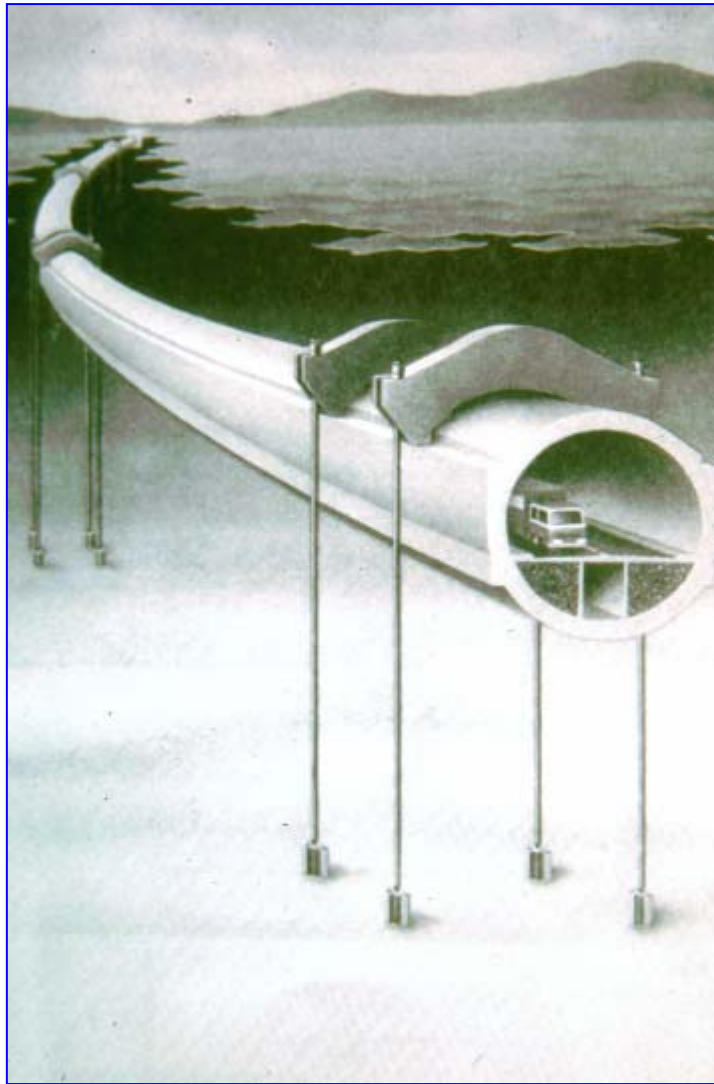

The picture is a courtesy of Transystems Inc., Fort Lee, NJ, USA

D. "The Harmony of Interest" by Henry C. Carey

Henry C. Carey is to be credited, perhaps more than any other single individual, with pursuing the policies which kept alive the American System of economics. From the late 1840s until his death in 1879, Carey organised in support of Alexander Hamilton's dirigist system of political economy. His leadership in that effort, especially as exercised through Abraham Lincoln's Treasury Department, enabled much of the 19th century technological development of the United States to take place.

Henry Carey's background is rooted in republican humanist traditions. His father, Mathew Carey, was an Irish republican revolutionary, strongly influenced by circles who were, in turn, influenced by Jonathan Swift. Mathew Carey was kicked out of Ireland for "defaming the British" when he resurrected Swift's "Modest Proposal for the Universal Use of Irish Manufactures." He then made his way to France, where he worked with Benjamin Franklin and General Lafayette. Upon his arrival in the United States, Carey became an ardent supporter of Hamilton.

The following are excerpts from Henry C. Carey's "The Harmony of Interests: Agriculture, Manufacturing, and Commercial," first published in 1851.

"...Two systems are before the world; the one looks to increasing the proportion of persons and of capital engaged in trade and transportation, and therefore to diminishing the proportion engaged in producing commodities with which to trade, with *necessarily* diminishing return to the labour of all; while the other looks to increasing the proportion engaged in the work of production, and diminishing that engaged in trade and transportation, with increased return to all, giving to the labourer good wages, and to the owner of capital goods profits. One looks to increasing the quantity of raw materials to be exported, and diminishing the inducements to import men, thus impoverishing both farmer and planter by throwing on them the burden of freight; while the other looks to increasing the import of men, and diminishing the export of raw materials, thereby enriching both planter and farmer by relieving them from the payment of freight. One looks to giving the *products* of millions of acres of land and of the labour of millions of men for the *services* of hundreds of thousands of distant men; the other to bringing distant men to consume on the land the products of the land, exchanging day's labour for day's labour. One looks to compelling the farmers and planters of the Union to continue their contributions for the support of the fleets and the armies, the paupers, the nobles, and the sovereigns of Europe; the other to enabling ourselves to apply the same means to the moral and intellectual improvement of the sovereigns of America. One looks to the continuance of that *bastard* freedom of trade which denies the principle of protection, yet doles it out as revenue duties; the other to extending the area of *legitimate* free trade

by the establishment of perfect protection, followed by the annexation of individuals and communities, and ultimately by the abolition of custom houses. One looks to exporting men to occupy desert tracts, the sovereignty of which is obtained by aid of diplomacy or war; importing men by millions for their occupation. One looks to the *centralization* of wealth and power in a great commercial city that shall rival the great cities of modern times, which have been and are being supported by aid of contributions which have exhausted every nation subjected to them; the other to *concentration*, by aid of which a market shall be made upon the land for the products of the land, and the farmer and planter be enriched. One looks to increasing the necessity for commerce; the other to increasing the power to maintain it. One looks to underworking the Hindoo, and sinking the rest of the world to his level; the other to raising the standard of man throughout the world to our level. One looks to pauperism, ignorance, depopulation, and barbarism; the other to increasing wealth, comfort, intelligence, combination of action, and civilization. One looks toward universal war; the other toward universal peace. One is the English system; the other we may be proud to call the American system, for it is the only one ever devised the tendency of which was that of *elevating* while *equalizing* the condition of man throughout the world.

“*Such* is the true *mission* of the people of these United States. To them has been granted a privilege never before granted to man, that of the exercise of the right of perfect self-government; but, as rights and duties are inseparable, with the grant of the former came the obligation to perform the latter. Happily their performance is pleasant and profitable, and involves no sacrifice. To raise the value of labour throughout the world, we need only to raise the value of our own. To diffuse intelligence and to promote the cause of morality throughout the world, we are required only to pursue the course that shall diffuse education throughout our own land, and shall enable every man more readily to acquire property, and with it respect for the rights of property. To improve the political condition of man throughout the world, it is needed that we ourselves should remain at peace, avoid taxation for the maintenance of fleets and armies, and become rich and prosperous. To raise the condition of woman throughout the world, it is required of us only that we pursue that course that enables men to remain at home and marry, that they may surround themselves with happy children and grandchildren. To substitute true Christianity for the detestable system known as the Malthusian, it is needed that we prove to the world that it is population that makes the food come from the rich soils, and that food tends to increase more rapidly than population, thus vindicating the policy of God to man. Doing these things, the addition to our population by immigration will speedily rise to millions, and with each and every year the desire for that

perfect freedom of trade which results from incorporation within the Union, will be seen to spread and to increase in its intensity, leading gradually to the establishment of an empire the most extensive and magnificent the world has yet seen, based upon principles of maintaining peace itself, and strong enough to insist upon the maintenance of peace by others, yet carried on without the aid of fleets, or armies, or taxes, the sales of public lands sufficing to pay the expenses of government.

“To establish such an empire - to prove that among the people of the world, whether agriculturists, manufacturers, or merchants, there is perfect harmony of interests, and that the happiness of individuals, as well as the grandeur of nations, is to be promoted by perfect obedience to that greatest of all commands, ‘Do unto others as ye would that others should do unto you,’ - is the object and will be the result of that mission. Whether that result shall be speedily attained, or whether it shall be postponed to a distant period, will depend greatly upon the men who are charged with the performance of the duties of government. If their movements be governed by that enlightened self-interest which induces man to seek his happiness in the promotion of that of his fellow-man, it will come soon. If, on the contrary, they be governed by that ignorant selfishness which leads to the belief that individuals, party, or national interests are to be promoted by measures tending to the deterioration of the condition of others, it will be late.”

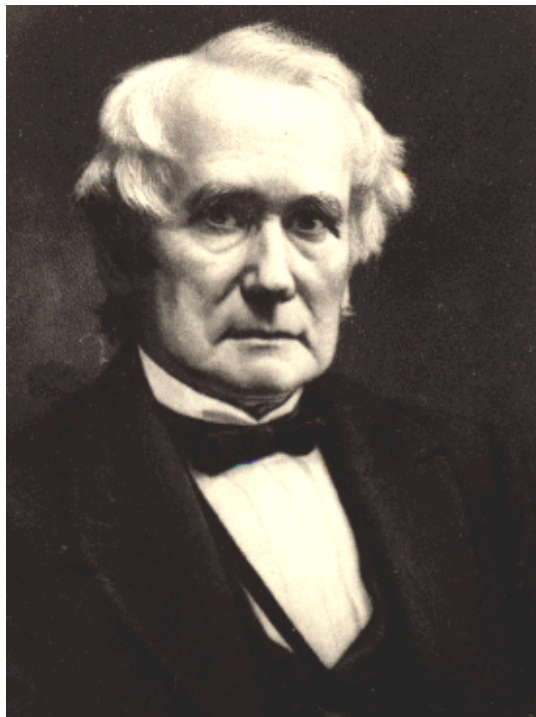

Henry Charles Carey

1793-1879

E. Call by the Ad Hoc Committee for a New Bretton Woods

August 12, 2007

Following up the previous calls of 1997, 2000, and 2006, in which thousands of prominent personalities from all over the world, among them former heads of state, members of parliaments, unionists, entrepreneurs, city officials, church members, members of the military, and so forth, demanded a reorganization of the world financial system, the Chairwoman of the Schiller Institute, Helga Zepp-LaRouche, has written the following new call, which will be circulated worldwide by the Schiller Institute. It should be published on the Internet and in various newspapers with the names of the signers, and will be presented to the American Congress and the parliaments of the world.

The systemic crash of the world financial system is in full swing. Shaken loose but not caused by the collapse of the subprime mortgage market in the U.S. and the end of the inflationary yen-carry-trade in Japan, the house of cards of "creative financial instruments," as Alan Greenspan has dubbed various credit derivatives, has thereby caved in. Because the takeover craze on the part of the hedge funds and private equity funds has been rising higher and higher over the recent years and months with ever wilder predatory raids, the investment banks which have financed the majority of these takeovers, are now left sitting on these worthless credits. More U.S. mortgage financiers will declare insolvency, more banks will go under in the vortex of the credit crisis. In the U.S. there are currently almost 10 trillion dollars in mortgage loans, over a third of which are bad credit risks. In Germany the examples of the IKB-Bank and the Westdeutsche LandesBank have shown that boards of directors are finding it hard to admit the quantity of their losses.

The myth that the central banks have an endless number of possibilities to always bring a crash under control, is exploding: they now find themselves between the Scylla of the fight against inflation with higher interest rates--which is urgent in the face of the obvious inflation of food, raw materials and oil, but would lead to bubbles like that of the U.S. mortgage market, and the like, bursting even more,--and the Charybdis of the credit crisis, which has been unleashed by the reversed leverage collapse. If the central banks try to stop a chain reaction by infusing liquidity in the range of hundreds of billions, as just occurred within 24 hours during the second week of August, this only means that there will be a hyperinflation like that in Weimar Germany 1923--only this time not in one country, but worldwide.

It is a dilemma from which there is no way out: the system is finished.

Catastrophic consequences are threatened for the world population. If countries can no longer finance their functions, societies threaten to sink into chaos.

The model of so-called globalization is today totally bankrupt, just as the communist model was in 1989-91. All the principles which are associated with it, such as "outsourcing" (that is, the shifting of highly qualified jobs into cheap-production countries), "shareholder value" society, "money-makes-money," "just-in-time" production, "benchmarking," etc. have been rejected. The condition of collapsing infrastructure in the G-7 countries is the best indicator of the wreckage of the unregulated free market economy.

In order to stop the intolerable suffering which an uncontrolled collapse of the world financial system threatens to unleash on the population, we, the undersigned, demand, the immediate convoking of an emergency conference which must decide on a new global financial architecture in the tradition of the Bretton Woods System initiated by Franklin D. Roosevelt in 1944.

We, the undersigned, also point out, that the Italian Parliament has taken up LaRouche's proposal, and in a resolution on April 6, 2005, called on the Italian government to convene "an international conference at the level of Heads of State and Government, to globally define a new and more just monetary and financial system."

The necessity for such a fundamental reorganization is all the more urgent today, but the potential for its realization has also grown. For an irony of history is responsible: Because when the Soviet Union began to unravel in 1991, the neo-conservatives in the government of President George Bush, Sr., saw to it by their policy of preemptive wars and regime change, that the process of cooperation among the nations of Eurasia and Latin America, which normally would have taken decades, has accelerated, under the influence of the American unilateralist policy. An array of heads of state of important countries have made it clear, that they have decided to defend the general welfare of their populations against the encroachment of the financial institutions associated with globalization. Therefore, the chances of putting the question of a just new world economic order on the agenda, have enormously increased.

But it would be a dangerous illusion to believe that a successful reorganization of the bankrupt world financial system could succeed without, or against, the United States. Therefore, we, the undersigned, declare ourselves in favor of cooperation with the "real" America, in the tradition of the American Revolution and the Declaration of Independence, that America which is connected with names such as Alexander Hamilton, John Quincy Adams, Abraham Lincoln, Franklin D. Roosevelt, and Martin Luther King, and which is inspired by Lyndon LaRouche today. America must be a part of the new community of principle of sovereign republics, which is bound together through the common interests of mankind.

In recent months Lyndon LaRouche has pointed out again and again that only the combination of a transformed America, together with Russia, China, and India, would be strong enough to put the question of a new monetary system on the agenda. But that does not mean that other nations could and should not participate as partners with these four large nations.

In order to correct the failures of development, which have occurred due to the paradigm shift of the past 40 years, and above all, since the abandonment of the system of fixed exchange rates by U.S. President Richard Nixon, in 1971, and which led, after the dissolution of the Soviet Union, with unrestrained globalization, to today's brutal vulture capitalism, we must implement the following measures:

The emergency conference for a New Bretton Woods must immediately thus resolve:

1. The current world financial system must be declared hopelessly bankrupt and be replaced by a new one.
2. A system of fixed exchange rates must be agreed upon immediately.
3. Derivatives speculation must be prohibited through an agreement among governments.
4. There must be put into effect a comprehensive reorganization, or, as the case may be, a cancellation of debts.
5. There must be put in place new credit lines, through state credit creation, in the tradition of Alexander Hamilton and the American System, which will make possible productive full employment, through investments in basic infrastructure and technological revival.
6. The completion of the Eurasian Land-Bridge, as the kernel of the reconstruction of the world economy, is thus the vision which will not only bring about an economic miracle, but also can become a system of peace for the 21st Century.
7. A new "Treaty of Westphalia" must guarantee the opening up and development of raw materials for all nations on this Earth, for at least the next 50 years.

We, the undersigned, are of the belief that the system of "globalization," with its brutal vulture capitalism, has economically, financially, and morally failed. In its place, man must again be put in the center, and the economy must serve the general welfare first and foremost. The new economic order must guarantee the inalienable rights of all mankind on this planet.

Signed: _____

Please send signed statement to: Schiller Institute
P.O. Box 20244, Washington, D.C. 20041-0244

BIBLIOGRAPHY

For further study of the American System of political economy, please consult the following:

1. [*The Harmony of Interests: Agriculture, Manufacturing and Commercial*](#), by Henry C. Carey.
2. *The Principles of Political Economy*, Vols. I, II and III, by Henry C. Carey.
3. *Industrial and Commercial Correspondences of Alexander Hamilton*, edited by Arthur Harrison Cole.
4. *The National System of Political Economy by Friedrich List*, translated from the German by Sampson S. Lloyd.
5. *Friedrich List, Outlines of American Political Economy*, by Friedrich List, newly edited and published by Dr. Böttiger Verlags-GmbH, Wiesbaden, Germany (in German with English translation).
6. [*Report on the Subject of Manufactures*](#), by Alexander Hamilton.
7. [*Report on a National Bank*](#), by Alexander Hamilton.
8. *The Political Economy of the American Revolution*, ed. Nancy Spannaus and Christopher White, Executive Intelligence Review, 1977, 1996.
9. [*The Science of Christian Economy*](#), by Lyndon H. LaRouche, Jr., Schiller Institute, 1991.
10. [*So, You Wish to Learn All About Economics?*](#), by Lyndon H. LaRouche, Jr., EIR News Service, Inc., 1995.
11. *The Road to Recovery*, by Lyndon H. LaRouche, Jr., LaRouche's Committee for a New Bretton Woods, 1999.
12. [*The Civil War and the American System - America's Battle with Britain, 1860-1876*](#), by W. Allen Salisbury.
15. *Sovereign Australia Part I & II: The Legislative Programme To Save Our Nation*, Citizens Electoral Councils of Australia. (For a copy, please contact please internet connection listed below)

INTERNET SITES

LaRouche Political Action Committee: <http://www.larouchepac.com/>

This site provides updates throughout the day on leading economic and political developments internationally.

Worldwide LaRouche Youth Movement: <http://wlym.com/tiki/tiki-index.php>

Executive Intelligence Review (USA): <http://www.larouchepub.com/index.html>

EIR New Agency (Europe): <http://www.eirna.com/english.htm>

American Almanac (*New Federalist*): http://members.tripod.com/~american_almanac/

Schiller Institute (Home Page): <http://schillerinstitute.org/>

This site has links to publications in various languages and Schiller Institute organisations in various countries.

New Bretton Woods: <http://www.schillerinstitute.org/economy/nbw/nbw.html>

Solidaité & Preogrè (France): http://www.solidariteetprogres.org/spip/sp_accueil.php3

21st Century Science & Technology: <http://www.21stcenturysciencetech.com/>

DYNAMIS – The Journal of the LaRouche-Riemann Method of Physical Economics:
<http://wlym.com/~seattle/dynamis/index.html>

Citizens Electoral Councils of Australia: <http://www.cecaust.com.au/>



BIOGRAPHY OF THE AUTHOR

Mark Calney has written articles published in America and Germany on *Richard Wagner and the Racist Roots of Nazi Ideology* and *D.W. Griffith: Hollywood and the Ku Klux Klan*. In 1989, he published a series of articles on *Sun Yat-sen and the American Roots of China's Republican Movement*. In addition, to extensive research and writings on California history, U.S.-Mexican industrial relations, and the U.S. 1876 Centennial Exposition, he has recently concluded an in-depth research project on the unique roll of America in the development of the modern nation of Japan. He has also contributed articles to Executive Intelligence Review magazine on Scottish affairs.

Mr. Calney and his family live in Altadena, California. He has been an organiser in the political movement of American statesman and economist Lyndon LaRouche for more than thirty years. In 1994, he was a Democratic Party candidate for Governor of the State of California, and has done several speaking tours of Scotland on the subject of this book. You can contact the author at: Calney@aol.com

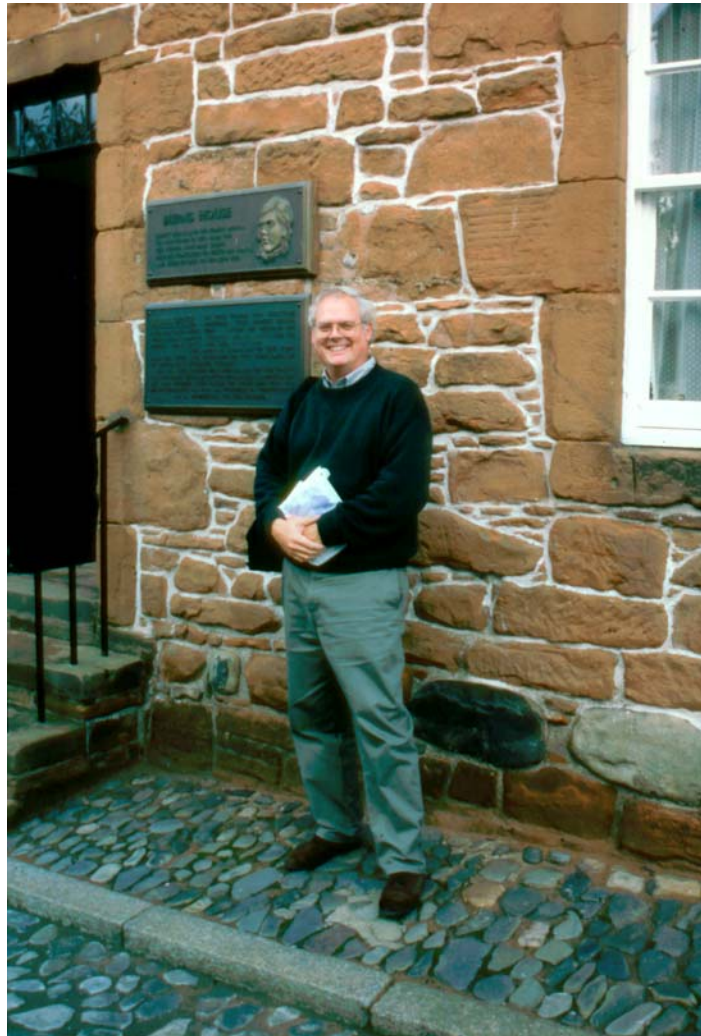

The author outside the home of Robert Burns in Dumfries, Scotland



ROBERT BURNS

Sponsors of the 1996 hard copy edition:

Sponsored by:

JAHANGIR-KHAN HANIF, Entrepreneur
JANET CAMERON, Doctor
DAVID STEVENSON, Academic
KEITH BOVEY, Solicitor
JAMES MacMILLAN, Composer
JOHN CARROL, Solicitor

Cover Photograph: STEPHEN KEARNEY

PUBLISHED BY: SCOTS FOR PEACE AND FREEDOM, P.O. BOX 1314, GLASGOW.
From whom additional copies may be obtained.

© 1996 by Scots for Peace and Freedom